



Standard programme

Multi-bladed reamers and counterboring tools

Welcome to the world of precision!

Founded in 1906 by August Beck as a mechanical workshop for fixed tools, the August BECK Präzisionswerkzeuge GmbH & Co. KG in Winterlingen is today the specialist for the precision machining of bores with multi-bladed reamers.

Countersinking tools complete the range. With this portfolio, our many years of experience and our special known-how, we have made a name for ourselves worldwide. Today BECK stands for the high quality and the precision of its products.

A broad range of standardised reaming and countersinking tools are available to our customers for reliable and cost-effective production. Starting from standardised reamers in accordance to DIN/ISO made of HSS-E or carbide, through high-performance reamers made of solid carbide or with brazed blades, right up to a modern replaceable head system, we offer a unique range of standard tools. This ensures that suitable tools, depending on the material to be machined, are always available from our versatile product range for demanding BECK customers to meet the required tolerance and the planned production volume.

All quality products from BECK are "Made in Germany". For majority of our standard products we guarantee availability ex stock and even intermediate sizes and special fits can be supplied in a short time by our machining specialists.

Furthermore, BECK manufactures a wide range of custom tools that offer benefits with respect to cost-effectiveness and productivity, particularly for the production of large quantities.

New developments are continuously added to our programme to address the increasing requirements in modern manufacturing and to offer solutions for high-performance machining and for new materials.

tool-traders-partner.com

August Beck GmbH & Co. KG in Winterlingen is a member of the "tool-traders-partner" association and utilises the benefits of this strong community to the benefit of its customers and the quality of its products.

You will find more information on the last page of this catalogue or in the Internet at www.tool-traders-partner.com.





CONTENTS

01 Introduction

Innovations Highlights	6
Overview of complete programme	8
Custom solutions	10
Standard programme	12
Selection system	14
Product index	18

02 High-performance reamers

HNC	21
MR reamers	65
RR reamers	97
VR reamers	111

03 Modular reaming

XR reamers	135
Multicut cutting rings	155
Shell reamers without internal cooling	185

04 Reaming without internal cooling

Machine reamers with carbide blades	199
Machine reamers made of HSS-E	231

05 Manual reaming

Hand reamers	285
Taper reamers	285

06 Countersinking

Countersinks EUC-Speed	311
Countersinks	311
Counterbores	333

07 Boring

Core drills with cylindrical shank / Morse taper shank	347
Shell core drills	347

08 Technical appendix

Cutting data recommendations	367
Handling notes	414

INNOVATIONS | HIGHLIGHTS

HNC ecoSpeed HSS reamer with internal cooling

High-performance reamer for small-scale series production

► [More from page 21](#)



BECK now offers the proven HNC high-performance reamers in a variant made of high speed steel (HSS) with internal cooling. Bore qualities in the range of IT7 are reliably achieved using the straight fluted tool.

The range includes high-performance reamers in the diameter range from 6 to 40 mm for machining steel and cast iron. Compared with standard HSS reamers, the HNC high-performance reamer

made of HSS achieves three times the performance and as such is at the level of a reamer made of solid carbide without internal cooling. The new reamer is 30 percent cheaper than a comparable DIN reamer made of solid carbide and therefore an economically appropriate alternative for small-scale series production. The cost saving is more significant above all at large diameters.

AT A GLANCE

- Straight fluted high-performance reamer made of HSS with internal cooling
- Performance level of solid carbide reamers without internal cooling
- 30 percent cheaper than a comparable DIN reamer made of solid carbide
- Large diameter particularly more economical

EUC-Speed

Extremely unequally spaced countersinks made of HSS or solid carbide with high-performance coating

► [More from page 311](#)



For optimal countersinking results, the cutting edges on the countersinks are extremely unevenly spaced. With this spacing, the axial force is reduced by more than 50 % compared with conventional countersinks.

The forces acting perpendicularly to the tool axis and vibration are also reduced, as a result higher accuracies and better surface finishes are achieved. The precision of the countersink leads to improved contact of bolted and riveted joints,

eliminating settling of the joint under load after assembly.

The reduced load on the machine extends the life of the tools. Due to the smooth, stable running, the tools can be operated with higher cutting data, resulting in considerable time savings. The counterboring tools are available as HSS and solid carbide variants with high-performance coating.

AT A GLANCE

- High accuracy
- Better surface finish
- Less vibration at the tool
- 50 % reduced axial forces and 25 % reduced radial forces compared with conventional countersinks
- No settling with bolted and riveted joints

WTE Hydraulic chuck Comp-R

For optimal performance during high-performance reaming

► [Ordering information page 63](#)



The hydraulic chuck "Comp-R" guarantees perfect radial run-out on the usage of multi-bladed reamers in a close tolerance range. The error on the total system due to the tolerances on the spindle, clamping tool and tool is compensated and perfect radial run-out guaranteed.

The "Comp-R" is perfectly suited to light machining tasks with multi-bladed reamers. In addition to the proven WTE hydraulic clamping techno-

logy, at three adjusting elements it is possible to set the radial run-out exactly in a setting range of up to 10 µm. The radial run-out is corrected straightforwardly and quickly using a hex wrench depending on the direction of the error. The system is self-locking, unintentional movement during fine machining is impossible.

AT A GLANCE

- Compensation of errors on the overall system
- Easy handling
- No jamming of the tool
- Better surface quality and tool life
- Dirt resistant and low maintenance

Replaceable head system XR 06 made of solid carbide

► [More from page 135](#)



The main argument in favour of the XR 06 is the significant price advantage compared with monoblock tools. In particular at diameters above 20 mm there is high potential for saving material costs. In this way valuable resources can be conserved and hard cash saved. The optimal design of the connection and cutting head makes it possible to use the XR 06 with the same cutting data as can be used with monoblock designs. The basic properties and advantages of the replaceable head reamers of course also apply to

the solid carbide variant. The tools will initially be available in a coated design with internal coolant supply for the high-performance machining of primarily steel and cast materials in the diameter range 8 or 10-40 mm for through bores and blind bores respectively. Variants for the economical machining of VA steel, aluminium, titanium, CFRP/GFRP as well as for machining hardened workpiece materials are available on request.

AT A GLANCE

- Particularly cost-effective from machining diameter 20 mm
- Flexible machining depths due to different holder lengths, even for smaller diameters
- Noticeably quicker and more reliable tool change without re-measuring

PRODUCT OVERVIEW



High-performance reamers with cylindrical shank

- 1 HNC reamers**
High-performance reamers made of HSS, solid carbide, solid cermet and with PcBN head
- 2 MR reamers**
Tipped high-performance reamers in fixed, expandable and finely adjustable designs
- 3 RR reamers**
Cast iron specialist with optimised coolant supply
- 4 VR reamers**
Maximum number of cutting edges without chip spaces for highest performance

Modular reaming

- 5 XR replaceable head system**
Solid carbide design and with brazed blades
- 6 MultiCut cutting rings**
Adjustable cutting rings with holder range
- 7 Shell reamers**
In accordance with DIN without internal coolant supply
- 8 Holders for modular reaming systems**



Reaming without internal cooling

9 Machine reamers in accordance to DIN or similar to DIN
Made of HSS-E and with carbide blades

10 Micro reamers made of solid carbide

Countersinking

11 Countersinks / counterbores
Made of solid carbide, HSS and with various coatings

Boring tools

12 Core drill
Made of HSS

Manual reaming

13 Hand reamers / taper reamers

CUSTOM SOLUTIONS

Multi-bladed reamers



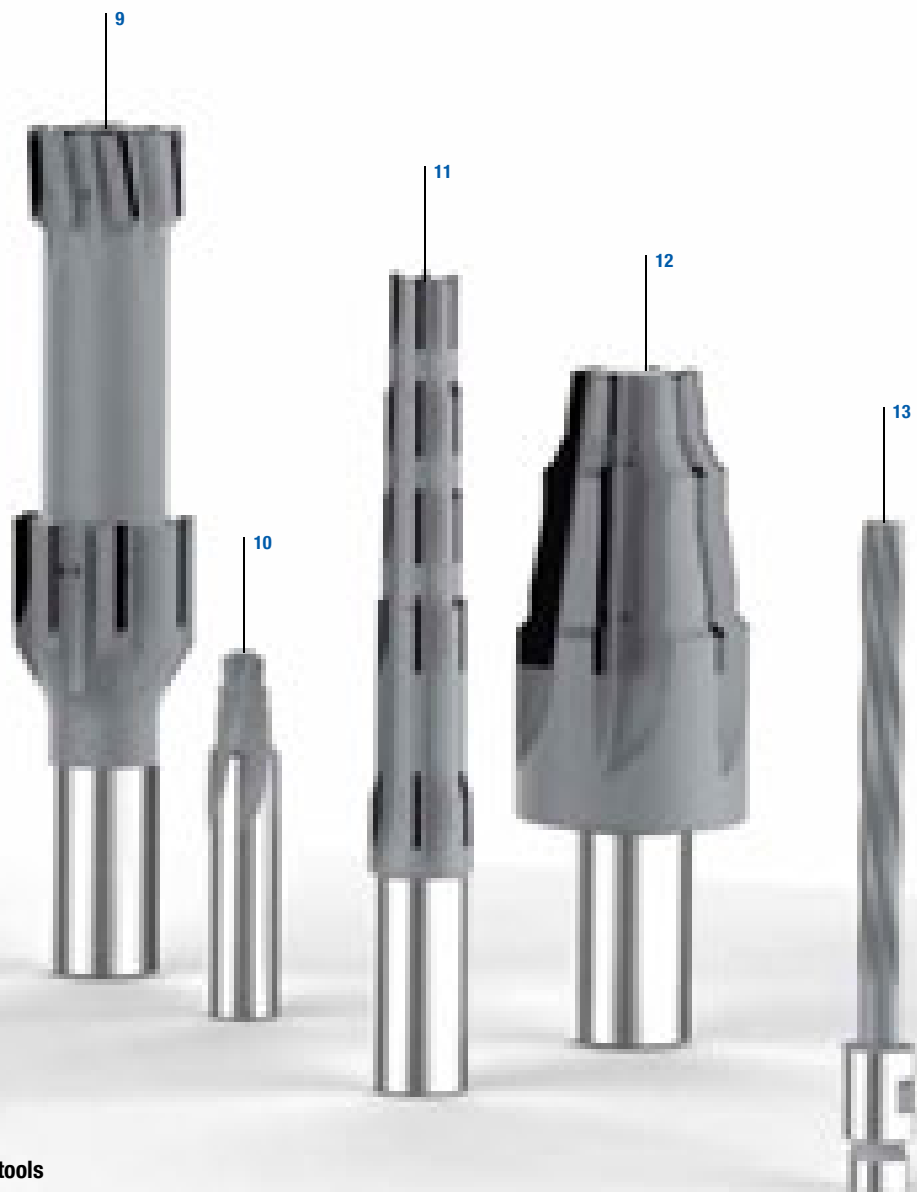

Custom solutions solid carbide tools

- 1 Two-stage custom tool with brazed blades for machining a hydraulic housing made of EN-GJS-500-7
- 2 Multi-stage coated solid carbide custom tool with chamfer and radius machining on a steel cylinder holder
- 3 Coated solid carbide step reamer for machining the injector bore in a cylinder head
- 4 Coated solid carbide step reamer for fine machining the contour of the spark plug bore in EN-GJL-250
- 5 Hand drill made of solid carbide for machining CFRP workpiece materials
- 6 Hand reamer made of solid carbide for machining composite workpiece materials
- 7 HSS machine taper reamer with MK shank
- 8 Solid carbide step reamer with VA geometry for machine a stainless steel valve block
- 9 Two-stage custom reamer with brazed cermet blades with combined straight and left-hand fluted design
- 10 Coated multi-stage solid carbide reamer with internal cooling on the shank for machining a rail
- 11 Step reamer with brazed half-round embedded cermet blades for machining a steel nozzle holder
- 12 Coated carbide-tipped form reamer for machining special turned parts
- 13 High-performance reamer with blunt brazed solid carbide head with custom connection for aerospace for machining a titanium, aluminium and high-alloy steel rivet hole combination

STANDARD PROGRAMME

High-performance reaming, reaming without internal cooling, manual reaming, countersinking, boring

Drastically reduced machining times are possible using fixed multi-bladed reamers. The multiple blades permit higher feed values, which at the end of the day define the machining times. Due to specifically developed systems and the latest manufacturing technology, BECK guarantees the highest accuracies on these tools. The product portfolio offers a wide variety that will satisfy all the requirements of the machining task: from monoblock versions to modern replaceable head systems.

The MultiCut range with cutting rings and tool holders is available for large diameters from 65 mm. The standard programmes are complemented by custom solutions that are adapted specifically to the related machining case.

In addition to the high-performance programme with internally cooled tools, a broad machine reamer programme without internal cooling in accordance to DIN or similar to DIN is available ex stock.



Basic Line:
Universal tools, broad application area, low procurement costs



Performance Line:
High-performance tools, broad application area, high productivity in series production.



Expert Line:
Specialist tools for selected applications, maximum precision and productivity

High-performance reamers with cylindrical shank



The innovative and further developed monoblock tools allow practically any materials to be machined. Even difficult to machine workpiece materials can be machined due to the ideal combination of geometry, cutting material and coating with high performance. BECK high-performance reamers with cylindrical shank are available in two different designs. On the one hand as tipped design with a tool body and brazed blades made of carbide, cermet, PcBN and PCD, on the other hand as a monolithic design made of solid carbide, HSS and solid cermet with blades that are machined from the tool body material.

Page 21

Modular reaming systems



BECK offers replaceable head reamers with different head systems. The programmes are divided into high-performance reamers, cutting ring systems for medium and large diameters and shell reamers without internal cooling. The replaceable head systems impress with exact radial run-out and changeover accuracy, and with safe and simple handling, particularly during assembly and dismantling. The related standard programme covers versions for through bores and blind bores as well as a broad choice of cutting materials.

Page 131

Reaming without internal cooling



NC machine reamers are a particularly inexpensive variant for the production of precision bores. Although the performance data are below those of high-performance reamers, these tools are widely used since they are characterised in particular by their simple handling. Here again, BECK offers a broad range of tools which are mostly available from stock or that can be delivered in intermediate dimensions at short notice.

Page 195



Manual reaming



Hand reamers are frequently the best choice for repair applications. The cylindrical shank with square drive allows a bore to be post-reamed using a tap wrench. But these tools are often also the only alternative at points inaccessible to machine tools. Using taper reamers, taper connections that as a rule are subjected to high mechanical loads can be manufactured straightforwardly and effectively.

Countersinking



Countersinking tools form a comprehensive complement for bore machining, as countersinking operations have to be carried out on practically all workpieces that are machined. The spectrum extends from simple deburring tools right up to the high-tech counterboring tool with extremely unequal cutting edge spacing.

Boring





HSS core drills are used to create the necessary allowance on a bore for the subsequent reaming. They are characterised by their simple handling. More important, however, is the matching of the diameter to the subsequent reaming operation. This eliminates the need for expensive drilling tools with intermediate diameters.

SELECTION OF MULTI-BLADED REAMERS

Step by step to the right reamer

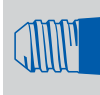
This selection aid guides you step by step to the right reamer.

1	Design	Select your preferred design (monolithic or modular).	>		Monolithic		Modular connection XS
2	Bore features	Check whether the geometric features meet your requirements. Select the diameter range and the required tolerance.	>	Diameter range	$\leq IT7$ $\geq IT7$	Achievable bore tolerance	
3	Product class	Decide for a product class.	>	Basic LINE	Basic Line: Universal tools, broad application area, low procurement costs		
4	Material suitability	Identify your workpiece material as per the BECK machining groups.	>	P	Steel	M	Stainless steel
5	Type of bore	Check the requirements that are placed on your tool by the type of bore.	>		Through bore		Blind bore
6	Product	Select your reamer. Select a pre-configured preferred series or configure as required.	>	Configuration as required	H7	H7 Preferred series	





Modular with Morse taper shank



Cutting ring



Performance Line:
High-performance tools, broad application area, high productivity in series production



Expert Line:
Specialist tools for selected applications, maximum precision and productivity



Cast iron



Non-ferrous metals and plastics



Composite materials



Super alloys and titanium



Hardened steel and cast steel



Interrupted cut



Selection system

Design		Recommended diameter range [mm]	Tolerance	Series			Product class		
					Diameter	Series			
	With internal cooling	6,00 - 40,00 (eco)	IT7	HNC / HCS / PcBN reamers		Standard reamers made of solid carbide, solid cermet, PcBN and HSS for almost all workpiece materials from \varnothing 3 mm.	6,00-40,00	HNC ecoSpeed, HSS	Performance LINE
							3,00-14,00	HNC, Speed, VA, Ti, Diamond, AL, HT	
							4,00-12,00	HCS	Expert LINE
							3,00-10,00	PcBN reamers	
	With internal cooling	14,00-40,00	IT7	IMR reamers		Reamer system with brazed blades in fixed, expandable and finely adjustable design.	14,00-40,00	MR 01 Fixed	Performance LINE
							14,00-40,00	MR 02 Expandable	Expert LINE
							14,00-40,00	MR 03 Finely adjustable	
	With internal cooling	4,00-40,00	IT7	RR 01		Coolant supply optimised especially for cast machining with HPC geometry in solid cermet and cermet tipped.	4,00-20,00	RR 01 Solid cermet head	Performance LINE
							21,00-40,00	RR 01 Cermet tipped	
							8,00-40,00	RR 01 Cermet tipped, expandable	
	With internal cooling	6,00-40,00	IT7	VR 01		Maximum number of teeth for maximum feeds and optimal circularity for through bores.	6,00-12,00	VR 01 Solid carbide	Expert LINE
							10,00-40,00	VR 01 Tipped	
Without internal cooling	0,6-50,00	IT7	Machine reamers		Machine reamers in accordance to DIN and works standard, made of HSS-E and with carbide blades, also with straight shank diameter suitable for hydraulic chucks and high-accuracy chucks	0,60-30,00	NC machine reamers in accordance to DIN with carbide blades	Basic LINE	
						1,00-40,00	Machine reamers in accordance to DIN with carbide blades		
						1,00-20,00	NC machine reamers in accordance to DIN made of HSS-E		
						1,00-50,00	Machine reamers in accordance to DIN made of HSS-E		
						8,00-40,00	Special reamers in acc. with DIN and WN with solid carbide blades		
						1,00-40,00	Special reamers in accordance to DIN and WN made of HSS-E		
Modular reamers	With internal cooling	8,00-40,00	IT7	XR		Replaceable head system in solid carbide and tipped design from diameter \varnothing 8.00 mm.	8,00-40,00	XR 06 Solid carbide	Performance LINE
							8,00-40,00	XR 01 Tipped	
	Without internal cooling	21,60-200,59			Multicut		Adjustable cutting rings and related holder range.	21,60-200,59	Multicut
Without internal cooling	25,00-100,00	IT7	Shell reamers		Shell reamers in accordance to DIN and tool related holders in accordance to DIN	25,00-100,00	Shell reamers in accordance with DIN with carbide blades	Basic LINE	
						25,00-100,00	Shell reamers in accordance with DIN made of HSS-E		

Step 1:
Design



Step 2:
Bore features



Step 3:
Product class



Step 4:
Material suitability



Step 5:
Type of bore



	Material suitability																Type of bore			Product	
	P					M	K			N			C	S	H		Diameter range (configurable)	Page			
	1-2	3	4	5	6	1-3	1	2	3	1-2	3.1	4.1	1	1-5	1	2					
	■	■	■	■			■	■	■								■	■	■	6,00-40,20	21
	■	■	■	■	■	■	■	■	■	■		■	■	■	■	■	■	■	■	2,80-20,20	
	■	■		■			■	■	■								■	■	■	3,70-12,10	
							■	■	■										■	3,00-10,200	
	■	■		■			■	■	■	■		■					■	■	■	7,70-40,20	65
	■	■		■			■	■	■								■	■	■	3,85-20,20	97
	■	■		■			★	■									■	■	■	20,21-40,20	
	■	■		■			★	■									■	■	■	7,70-40,20	
	■	■		■			■	■	■	■							■	★	■	5,70-12,20	111
	■	■	■	■	■		■	■	■	■					■				■	9,76-40,25	
	■	■		■		○	■	■	■	■		■			○		■	■	■	0,6-30,20	199
	■	■		■		○	■	■	■	■		■			○		■	■	■	0,95-40,16	199
	■	■		■			■	■	■	■		■					■	■	■	0,95-20,00	231
	■	■		■			■	■	■	■		■					■	■	■	0,95-50,10	231
	■	■		■		○	■	■	■	■		■			○				■	7,70-40,20	199
	■	■		■			■	■	■	■		■							■	0,95-40,00	231
	■	■		■			■	■	■								■	■	■	8,00-40,20	135
	■	■		■			■	■	■	■		■					■	■	■	21,60-200,59	155
	■	■		■		○	■	■	■	■		■			○		■	■	■	24,80-100,20	185
	■	■		■			■	■	■	■		■					■	■	■		

INDEX

Preferred series and configurable series

Preferred series		
Product code	Standard	Page
010010	DIN 206	288-289
010011	DIN 206	292-293
011010	DIN 859	296-297
011011	DIN 859	296-297
012011	WN 50	300
012013	WN 50	301
012014	WN 50	301
012015	Sets WN 50	300
012016	Sets WN 50	300
020011	DIN 9	304
021010	DIN 2179	302
021011	DIN 2180	303
024011	DIN 204	305
030010	DIN 311	278
030110	DIN 208	265
030111	DIN 208	267-268
030310	DIN 208	276
030505	DIN 212-3	232-234
030507	DIN 212-3	236
030510	DIN 212-1/2	237
030511	DIN 212-1/2	239-241
030513	DIN 212-1/2	245-264
030610	DIN 212-1/2	274
030716	DIN 8089	272
030810	WN 141	279
030811	WN 142	281
031211	DIN 219	188-189
031310	DIN 219	191
031610	DIN 217	193+365
031611	DIN 217	193+365
031612	DIN 217	193+365
033111	DIN 208	270
033260	HNC ecoSpeed	60
033261	HNC ecoSpeed	61
033511	DIN 212-2	243
040200	DIN 8093-1	211
040201	DIN 8093-1	213
040210	DIN 8093-2	200
040211	DIN 8093-2	203-205
040230	DIN 8090	215
040240	Similar DIN 8093	202
040245	Similar DIN 8093	209
040260	HNC	24-25
040261	HNC	42-43
040311	Similar DIN 8050	225
040325	RR 01	100
040326	RR 01	102
040327	RR 01	104
040340	RR 01	106
040341	RR 01	108
040356	PcBN	40
040360	HCS	36-37
040366	PcBN	56

Preferred series		
Product code	Standard	Page
040370	VR 01	116-117
040372	VR 01	120-121
040374	VR 01	126-127
040376	VR 01	122-123
040378	VR 01	124-125
040382	VR 01	118-119
040390	VR 01	114
040420	DIN 8094	217
040421	DIN 8094	221
040422	DIN 8094	219
040423	DIN 8094	223
040511	Similar DIN 8051	227
040512	WN 280	229
040910	DIN 8054	186
041020	DIN 335	316
041610	MR 01	68
041611	MR 01	69
041612	MR 01	70
041613	MR 01	71
041650	MR 01	82
041651	MR 01	83
041652	MR 01	84
041653	MR 01	85
041710	MR 02	72
041711	MR 02	73
041712	MR 02	74
041713	MR 02	75
041750	MR 02	86
041751	MR 02	87
041752	MR 02	88
041753	MR 02	89
041810	MR 03	76
041811	MR 03	77
041812	MR 03	78
041813	MR 03	79
041850	MR 03	90
041851	MR 03	91
041852	MR 03	92
041853	MR 03	93
043211	DIN 8093-2	207
043250	HNC-AL	33
043251	HNC-AL	51
043260	HNC-Speed	26-27
043261	HNC-Speed	44-45
043265	HNC-Short	57
043270	HNC-VA	28-29
043271	HNC-VA	46-47
043272	HNC-TI	30-31
043273	HNC-TI	48-49
043280	HNC-HT	34-35
043281	HNC-HT	52-53
043290	HNC Diamond	32
043291	HNC Diamond	50

Preferred series		
Product code	Standard	Page
044210	EUC-Speed	314
050010	DIN 344	350
050011	DIN 344	351
050110	DIN 343	353-354
050111	DIN 343	355-356
050310	DIN 222	359-360
050311	DIN 222	361-362
050610	DIN 334	330
050810	DIN 335	325
051010	WN 180	331
051011	WN 181	326
051110	DIN 334	327
051111	DIN 334	329
051207	DIN 335	320
051210	DIN 335	317
051211	DIN 335	324
051218	DIN 335	317
051310	DIN 335	322
051510	DIN 373	334
051511	DIN 373	336
051512	DIN 373	338
051513	DIN 373	334
051514	DIN 373	336
051515	DIN 373	338
051610	DIN 375	341
051611	DIN 1868	342-344
051710	WN 178	339
051711	WN 178	340
053207	DIN 335	321
053210	DIN 335	319
053212	DIN 335	318
053220	DIN 335	319
053310	DIN 335	323
053320	DIN 334	328
053510	DIN 373	335
053511	DIN 373	337
054210	EUC-Speed	315
054218	EUC-Speed	315
081605	XR 01	141
081610	XR 01	137
081611	XR 01	139
081612	XR 01	140
081618	XR 01	138
081631	XR 06	136
081650	XR 01	145
081651	XR 01	146
081652	XR 01	148
081655	XR 01	149
081659	XR 01	147
081661	XR 06	144
085101	XR holders	152

Configurable series			Configurable series			Configurable series		
Product code	Standard	Page	Product code	Standard	Page	Product code	Standard	Page
010010	DIN 206	290-291	040356	PcBN	41	041812	MR 03	80-81
010011	DIN 206	294-295	040360	HCS	38-39	041813	MR 03	80-81
011010	DIN 859	298-299	040366	PcBN	58-59	041850	MR 03	94-95
011011	DIN 859	298-299	040370	VR 01	128-129	041851	MR 03	94-95
030110	DIN 208	266	040372	VR 01	128-129	041852	MR 03	94-95
030111	DIN 208	269	040374	VR 01	128-129	041853	MR 03	94-95
030310	DIN 208	277	040376	VR 01	128-129	043211	DIN 8093-2	208
030505	DIN 212-3	235	040378	VR 01	128-129	043250	HNC-AL	38-39
030510	DIN 212-1/2	238	040382	VR 01	128-129	043251	HNC-AL	54-55
030511	DIN 212-1/2	242	040390	VR 01	115	043260	HNC-Speed	38-39
030610	DIN 212-1/2	275	040420	DIN 8094	218	043261	HNC-Speed	54-55
030716	DIN 8089	273	040421	DIN 8094	222	043265	HNC-Short	58-59
030810	WN 141	280	040422	DIN 8094	220	043270	HNC-VA	38-39
030811	WN 142	282	040423	DIN 8094	224	043271	HNC-VA	54-55
031211	DIN 219	190	040511	Similar DIN 8051	228	043272	HNC-TI	38-39
031310	DIN 219	192	040910	DIN 8054	187	043273	HNC-TI	54-55
033111	DIN 208	271	041610	MR 01	80-81	043280	HNC-HT	38-39
033260	HNC ecoSpeed	62	041611	MR 01	80-81	043281	HNC-HT	54-55
033261	HNC ecoSpeed	62	041612	MR 01	80-81	043290	HNC Diamond	38-39
033511	DIN 212-2	244	041613	MR 01	80-81	043291	HNC Diamond	54-55
040200	DIN 8093-1	212	041650	MR 01	94-95	050010	DIN 344	352
040201	DIN 8093-1	214	041651	MR 01	94-95	050110	DIN 343	357-358
040210	DIN 8093-2	201	041652	MR 01	94-95	050310	DIN 222	363-364
040211	DIN 8093-2	206	041653	MR 01	94-95	081605	XR 01	142-143
040230	DIN 8090	216	041710	MR 02	80-81	081610	XR 01	142-143
040245	Similar DIN 8093	210	041711	MR 02	80-81	081611	XR 01	142-143
040260	HNC	38-39	041712	MR 02	80-81	081612	XR 01	142-143
040261	HNC	54-55	041713	MR 02	80-81	081618	XR 01	142-143
040311	Similar DIN 8050	226	041750	MR 02	94-95	081631	XR 06	142-143
040325	RR 01	101	041751	MR 02	94-95	081650	XR 01	150-151
040326	RR 01	103	041752	MR 02	94-95	081651	XR 01	150-151
040327	RR 01	105	041753	MR 02	94-95	081652	XR 01	150-151
040340	RR 01	107	041810	MR 03	80-81	081655	XR 01	150-151
040341	RR 01	109	041811	MR 03	80-81	081659	XR 01	150-151
						081661	XR 06	150-151





HNC REAMERS

Introduction

Product overview	22
------------------	----

Series for through bore

HNC	040260	24
HNC-AL	043250	33
HNC-Speed	043260	26
HNC-VA	043270	28
HNC-TI	043272	30
HNC-HT	043280	34
HNC-Diamond	043290	32
HCS	040360	36
PcBN reamer	040356	40
HNC ecoSpeed	033260	60
Overview configurable series HNC, HCS		38
Overview configurable series PcBN reamers		41
Overview configurable series HNC ecoSpeed		62

Series for blind bore

HNC	040261	42
HNC-AL	043251	51
HNC-Speed	043261	44
HNC-VA	043271	46
HNC-TI	043273	48
HNC-HT	043281	52
HNC-Diamond	043291	50
HNC-Short	043265	57
PcBN reamer	040366	56
HNC ecoSpeed	033261	61
Overview configurable series HNC		54
Overview configurable series PcBN reamers		58
Overview configurable series HNC-Short		58
Overview configurable series HNC ecoSpeed		62

Accessoires

Hydraulic chuck "Comp-R", HSK-A63, SK50	63
---	----

PRODUCT OVERVIEW



High-performance reamer HNC - a suitable tool for every application and every material

The series of high-performance reamers HNC made of solid carbide, solid cermet, PcBN and HSS covers a broad range of applications. Depending on the diameter, the high-performance reamers HNC have between four and eight cutting edges with internal cooling and achieve correspondingly high feed rates. Due to the usage of different cutting materials and coatings, all workpiece materials can be machined economically and reliably in the diameter range 3.00 to

40.00 mm* without an adjustment process in the range IT7. In addition, extremely hard cutting materials, e.g. PcBN, can be used for reaming with the new series.

For usage in tight spaces, for example on automated lathes, short designs are available.

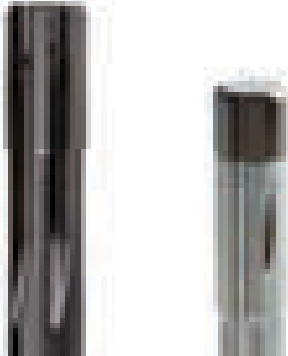

High-performance reamers HNC made of solid carbide	High-performance reamers HNC made of solid carbide and PcBN	High-performance reamers HCS made of solid cermet
		
<p>High-performance reamers made of solid carbide, spiral fluted, with internal cooling. Preferred series with tolerance H7 and + 0.004 mm, configurable series for intermediate diameters and special tolerances.</p> <p>Ø range: 3.00 - 20.00 mm*</p> <div data-bbox="140 1827 209 1890"> </div> <div data-bbox="140 1921 347 1989"> </div> <div data-bbox="140 2018 347 2051"> </div>	<p>High-performance reamers made of solid carbide or with PcBN head, straight fluted, with internal cooling. Preferred series with tolerance H7 and + 0.004 mm, configurable series for intermediate diameters and special tolerances.</p> <p>Ø range: 4.00 - 20.00 mm*</p> <div data-bbox="603 1805 735 1890"> </div> <div data-bbox="603 1921 799 1989"> </div> <div data-bbox="603 2018 699 2051"> </div>	<p>High-performance reamers made of solid cermet, spiral fluted, with internal cooling. Preferred series with tolerance H7 and + 0.004 mm, configurable series for intermediate diameters and special tolerances.</p> <p>Ø range: 3.97 - 12.03 mm*</p> <div data-bbox="1043 1827 1112 1890"> </div> <div data-bbox="1043 1921 1251 1989"> </div> <div data-bbox="1043 2018 1112 2051"> </div>
<p>Page 24</p>	<p>Page 33</p>	<p>Page 36</p>

* The diameter range can vary, depending on the series.



High-performance reamers HNC made of solid carbide and PcBN

High-performance reamers HNC-Short made of solid carbide

High-performance reamers HNC ecoSpeed made of HSS

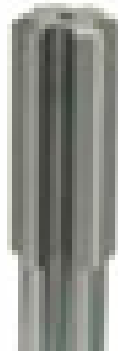
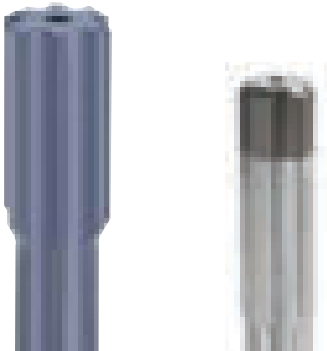

High-performance reamers made of solid carbide or with PcBN head, straight fluted, with internal cooling. Preferred series with tolerance H7 and + 0.004 mm, configurable series for intermediate diameters and special tolerances.

Ø range: 3.00 - 20.00 mm*

Carbide PcBN
Performance Expert
 LINE LINE

+4 µm **H7**

P M K N C S H

Extra short high-performance reamer made of solid carbide that is specially designed for usage on automated lathes.

Ø range: 3.00 - 20.00 mm

Performance
 LINE

H7

P K

Design made of HSS with high-performance coating for through and blind bores.

Ø range: 6.00 - 40.00 mm

Performance
 LINE

H7

P K

HNC I 040260

Preferred series for through bore, internal coolant supply

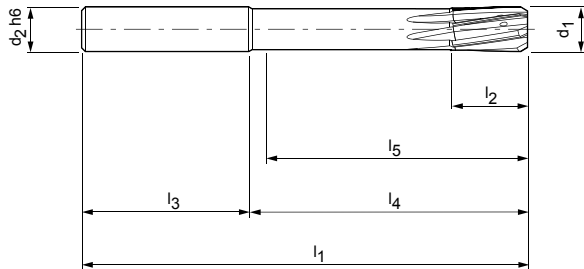

Design:

Diameter:

Cutting direction:

Cutting material:

Flute direction:

Geometry:

3,00-20,00 mm

Right-hand cutting

Solid carbide,

uncoated

Spiral fluted

HPC, EU spacing



Dimensions								z	Order No.
d ₁	Tolerance	d ₂ h6	l ₁	l ₂	l ₃	l ₄	l ₅		
3,00	H7	4	65	12	28	37	34	4	30402429
3,20	H7	4	65	12	28	37	34	4	30402431
3,50	H7	4	65	12	28	37	34	4	30402433
3,97	+0,004	6	75	12	36	39	34	4	30131192
3,98	+0,004	6	75	12	36	39	34	4	30131194
3,99	+0,004	6	75	12	36	39	34	4	30131196
4,00	H7	6	75	12	36	39	34	4	30131198
4,01	+0,004	6	75	12	36	39	34	4	30131200
4,02	+0,004	6	75	12	36	39	34	4	30131202
4,03	+0,004	6	75	12	36	39	34	4	30131204
4,50	H7	6	75	12	36	39	34	4	30131206
4,97	+0,004	6	75	12	36	39	35	4	30131208
4,98	+0,004	6	75	12	36	39	35	4	30131210
4,99	+0,004	6	75	12	36	39	35	4	30131212
5,00	H7	6	75	12	36	39	35	4	30131214
5,01	+0,004	6	75	12	36	39	35	4	30131216
5,02	+0,004	6	75	12	36	39	35	4	30131218
5,03	+0,004	6	75	12	36	39	35	4	30131220
5,50	H7	6	75	12	36	39	35	4	30131222
5,97	+0,004	6	75	12	36	39	35	4	30131224
5,98	+0,004	6	75	12	36	39	35	4	30131226
5,99	+0,004	6	75	12	36	39	35	4	30131228
6,00	H7	6	75	12	36	39	35	4	30131230
6,01	+0,004	6	75	12	36	39	35	4	30131232
6,02	+0,004	6	75	12	36	39	35	4	30131234
6,03	+0,004	6	75	12	36	39	35	4	30131236
6,50	H7	8	100	16	36	64	59	6	30131238
7,00	H7	8	100	16	36	64	59	6	30131240
7,50	H7	8	100	16	36	64	60	6	30131242
7,97	+0,004	8	100	16	36	64	60	6	30131244
7,98	+0,004	8	100	16	36	64	60	6	30131246
7,99	+0,004	8	100	16	36	64	60	6	30131248
8,00	H7	8	100	16	36	64	60	6	30131250
8,01	+0,004	8	100	16	36	64	60	6	30131252
8,02	+0,004	8	100	16	36	64	60	6	30131254
8,03	+0,004	8	100	16	36	64	60	6	30131256
8,50	H7	10	100	20	40	60	55	6	30131258
9,00	H7	10	100	20	40	60	55	6	30131260
9,50	H7	10	120	20	40	80	76	6	30131262

HNC I 040260, preferred series for through bore, internal coolant supply

Dimensions								z	Order No.
d ₁	Tolerance	d ₂ h6	l ₁	l ₂	l ₃	l ₄	l ₅		
9,97	+0,004	10	120	20	40	80	76	6	30131264
9,98	+0,004	10	120	20	40	80	76	6	30131266
9,99	+0,004	10	120	20	40	80	76	6	30131268
10,00	H7	10	120	20	40	80	76	6	30131270
10,01	+0,004	10	120	20	40	80	76	6	30131272
10,02	+0,004	10	120	20	40	80	76	6	30131274
10,03	+0,004	10	120	20	40	80	76	6	30131276
10,50	H7	12	120	20	45	75	70	6	30131278
11,00	H7	12	120	20	45	75	70	6	30131280
11,50	H7	12	120	20	45	75	71	6	30131282
11,97	+0,004	12	120	20	45	75	71	6	30131284
11,98	+0,004	12	120	20	45	75	71	6	30131286
11,99	+0,004	12	120	20	45	75	71	6	30131288
12,00	H7	12	120	20	45	75	71	6	30131290
12,01	+0,004	12	120	20	45	75	71	6	30131292
12,02	+0,004	12	120	20	45	75	71	6	30131294
12,03	+0,004	12	120	20	45	75	71	6	30131296
13,00	H7	14	130	22	45	85	80	6	30131298
14,00	H7	14	130	22	45	85	80	6	30131300
15,00	H7	16	130	22	48	82	77	6	30131302
16,00	H7	16	150	25	48	102	97	6	30131304
17,00	H7	18	150	25	48	102	97	8	30131306
18,00	H7	18	150	25	48	102	97	8	30131308
19,00	H7	20	150	25	50	100	95	8	30131310
20,00	H7	20	150	25	50	100	95	8	30131312

Dimensions in mm.

Cutting data see page 367 ff.

Intermediate diameters and special tolerances can be ordered by the overview pages for configurable series on page 38.

HNC-Speed I 043260

Preferred series for through bore, internal coolant supply

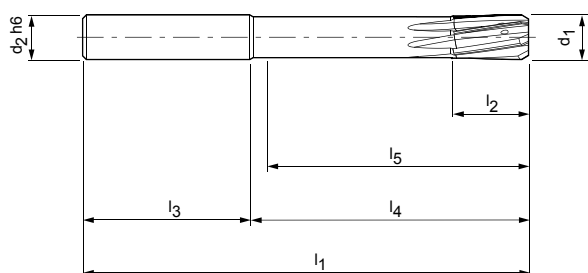

Design:

Diameter:

Cutting direction:

Cutting material:

Flute direction:

Geometry:

3,00-20,00 mm

Right-hand cutting

Solid carbide,

BSP coated

Spiral fluted

HPC, EU spacing



Dimensions								z	Order No.
d_1	Tolerance	$d_2 h_6$	l_1	l_2	l_3	l_4	l_5		
3,00	H7	4	65	12	28	37	34	4	30402444
3,20	H7	4	65	12	28	37	34	4	30402446
3,50	H7	4	65	12	28	37	34	4	30402448
3,97	+0,004	6	75	12	36	39	34	4	30131436
3,98	+0,004	6	75	12	36	39	34	4	30131438
3,99	+0,004	6	75	12	36	39	34	4	30131440
4,00	H7	6	75	12	36	39	34	4	30131442
4,01	+0,004	6	75	12	36	39	34	4	30131444
4,02	+0,004	6	75	12	36	39	34	4	30131446
4,03	+0,004	6	75	12	36	39	34	4	30131448
4,50	H7	6	75	12	36	39	34	4	30131450
4,97	+0,004	6	75	12	36	39	35	4	30131452
4,98	+0,004	6	75	12	36	39	35	4	30131454
4,99	+0,004	6	75	12	36	39	35	4	30131456
5,00	H7	6	75	12	36	39	35	4	30131458
5,01	+0,004	6	75	12	36	39	35	4	30131460
5,02	+0,004	6	75	12	36	39	35	4	30131462
5,03	+0,004	6	75	12	36	39	35	4	30131464
5,50	H7	6	75	12	36	39	35	4	30131466
5,97	+0,004	6	75	12	36	39	35	4	30131468
5,98	+0,004	6	75	12	36	39	35	4	30131470
5,99	+0,004	6	75	12	36	39	35	4	30131472
6,00	H7	6	75	12	36	39	35	4	30131474
6,01	+0,004	6	75	12	36	39	35	4	30131476
6,02	+0,004	6	75	12	36	39	35	4	30131478
6,03	+0,004	6	75	12	36	39	35	4	30131480
6,50	H7	8	100	16	36	64	59	6	30131482
7,00	H7	8	100	16	36	64	59	6	30131484
7,50	H7	8	100	16	36	64	60	6	30131486
7,97	+0,004	8	100	16	36	64	60	6	30131488
7,98	+0,004	8	100	16	36	64	60	6	30131490
7,99	+0,004	8	100	16	36	64	60	6	30131492
8,00	H7	8	100	16	36	64	60	6	30131494
8,01	+0,004	8	100	16	36	64	60	6	30131496
8,02	+0,004	8	100	16	36	64	60	6	30131498
8,03	+0,004	8	100	16	36	64	60	6	30131500
8,50	H7	10	100	20	40	60	55	6	30131502
9,00	H7	10	100	20	40	60	55	6	30131504
9,50	H7	10	120	20	40	80	76	6	30131506

HNC-Speed I 043260, preferred series for through bore, internal coolant supply

Dimensions								z	Order No.
d ₁	Tolerance	d ₂ h6	l ₁	l ₂	l ₃	l ₄	l ₅		
9,97	+0,004	10	120	20	40	80	76	6	30131508
9,98	+0,004	10	120	20	40	80	76	6	30131510
9,99	+0,004	10	120	20	40	80	76	6	30131512
10,00	H7	10	120	20	40	80	76	6	30131514
10,01	+0,004	10	120	20	40	80	76	6	30131516
10,02	+0,004	10	120	20	40	80	76	6	30131518
10,03	+0,004	10	120	20	40	80	76	6	30131520
10,50	H7	12	120	20	45	75	70	6	30131522
11,00	H7	12	120	20	45	75	70	6	30131524
11,50	H7	12	120	20	45	75	71	6	30131526
11,97	+0,004	12	120	20	45	75	71	6	30131528
11,98	+0,004	12	120	20	45	75	71	6	30131530
11,99	+0,004	12	120	20	45	75	71	6	30131532
12,00	H7	12	120	20	45	75	71	6	30131534
12,01	+0,004	12	120	20	45	75	71	6	30131536
12,02	+0,004	12	120	20	45	75	71	6	30131538
12,03	+0,004	12	120	20	45	75	71	6	30131540
13,00	H7	14	130	22	45	85	80	6	30131542
14,00	H7	14	130	22	45	85	80	6	30131544
15,00	H7	16	130	22	48	82	77	6	30131546
16,00	H7	16	150	25	48	102	97	6	30131548
17,00	H7	18	150	25	48	102	97	8	30131550
18,00	H7	18	150	25	48	102	97	8	30131552
19,00	H7	20	150	25	50	100	95	8	30131554
20,00	H7	20	150	25	50	100	95	8	30131556

Dimensions in mm.

Cutting data see page 367 ff.

Intermediate diameters and special tolerances can be ordered by the overview pages for configurable series on page 38.

HNC-VA I 043270

Preferred series for through bore, internal coolant supply

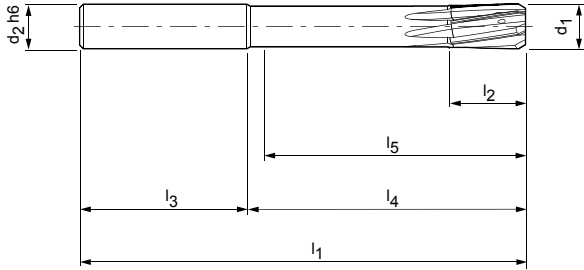

Design:

Diameter:
Cutting direction:
Cutting material:

3,97-20,00 mm
Right-hand cutting
Solid carbide,
BVA coated

Flute direction:
Geometry:

Spiral fluted
HPC, EU spacing



Dimensions								z	Order No.
d_1	Tolerance	$d_2 h_6$	l_1	l_2	l_3	l_4	l_5		
3,97	+0,004	6	75	12	36	39	34	4	30195076
3,98	+0,004	6	75	12	36	39	34	4	30195079
3,99	+0,004	6	75	12	36	39	34	4	30195080
4,00	H7	6	75	12	36	39	34	4	30195082
4,01	+0,004	6	75	12	36	39	34	4	30195083
4,02	+0,004	6	75	12	36	39	34	4	30195085
4,03	+0,004	6	75	12	36	39	34	4	30195086
4,50	H7	6	75	12	36	39	34	4	30195087
4,97	+0,004	6	75	12	36	39	35	4	30195089
4,98	+0,004	6	75	12	36	39	35	4	30195090
4,99	+0,004	6	75	12	36	39	35	4	30195092
5,00	H7	6	75	12	36	39	35	4	30195094
5,01	+0,004	6	75	12	36	39	35	4	30195095
5,02	+0,004	6	75	12	36	39	35	4	30195097
5,03	+0,004	6	75	12	36	39	35	4	30195098
5,50	H7	6	75	12	36	39	35	4	30195101
5,97	+0,004	6	75	12	36	39	35	4	30195102
5,98	+0,004	6	75	12	36	39	35	4	30195104
5,99	+0,004	6	75	12	36	39	35	4	30195106
6,00	H7	6	75	12	36	39	35	4	30195108
6,01	+0,004	6	75	12	36	39	35	4	30195109
6,02	+0,004	6	75	12	36	39	35	4	30195111
6,03	+0,004	6	75	12	36	39	35	4	30195112
6,50	H7	8	100	16	36	64	59	6	30195113
7,00	H7	8	100	16	36	64	59	6	30195115
7,50	H7	8	100	16	36	64	60	6	30195116
7,97	+0,004	8	100	16	36	64	60	6	30195117
7,98	+0,004	8	100	16	36	64	60	6	30195119
7,99	+0,004	8	100	16	36	64	60	6	30195121
8,00	H7	8	100	16	36	64	60	6	30195122
8,01	+0,004	8	100	16	36	64	60	6	30195123
8,02	+0,004	8	100	16	36	64	60	6	30195124
8,03	+0,004	8	100	16	36	64	60	6	30195125
8,50	H7	10	100	20	40	60	55	6	30195127
9,00	H7	10	100	20	40	60	55	6	30195132
9,50	H7	10	120	20	40	80	76	6	30195133
9,97	+0,004	10	120	20	40	80	76	6	30195134
9,98	+0,004	10	120	20	40	80	76	6	30195135
9,99	+0,004	10	120	20	40	80	76	6	30195136

HNC-VA I 043270, preferred series for through bore, internal coolant supply

Dimensions								z	Order No.
d ₁	Tolerance	d ₂ h6	l ₁	l ₂	l ₃	l ₄	l ₅		
10,00	H7	10	120	20	40	80	76	6	30195138
10,01	+0,004	10	120	20	40	80	76	6	30195140
10,02	+0,004	10	120	20	40	80	76	6	30195142
10,03	+0,004	10	120	20	40	80	76	6	30195143
10,50	H7	12	120	20	45	75	70	6	30195144
11,00	H7	12	120	20	45	75	70	6	30195146
11,50	H7	12	120	20	45	75	71	6	30195147
11,97	+0,004	12	120	20	45	75	71	6	30195148
11,98	+0,004	12	120	20	45	75	71	6	30195150
11,99	+0,004	12	120	20	45	75	71	6	30195153
12,00	H7	12	120	20	45	75	71	6	30195155
12,01	+0,004	12	120	20	45	75	71	6	30195159
12,02	+0,004	12	120	20	45	75	71	6	30195165
12,03	+0,004	12	120	20	45	75	71	6	30195168
13,00	H7	14	130	22	45	85	80	6	30195169
14,00	H7	14	130	22	45	85	80	6	30195170
15,00	H7	16	130	22	48	82	77	6	30195172
16,00	H7	16	150	25	48	102	97	6	30195175
17,00	H7	18	150	25	48	102	97	8	30195178
18,00	H7	18	150	25	48	102	97	8	30195182
19,00	H7	20	150	25	50	100	95	8	30195185
20,00	H7	20	150	25	50	100	95	8	30195188

Dimensions in mm.

Cutting data see page 367 ff.

Intermediate diameters and special tolerances can be ordered by the overview pages for configurable series on page 38.

HNC-TI | 043272

Preferred series for through bore, internal coolant supply

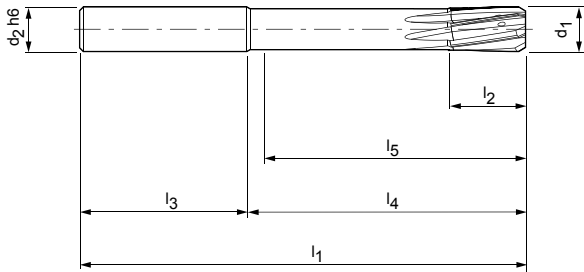

Design:

Diameter:
Cutting direction:
Cutting material:

3,97-20,00 mm
Right-hand cutting
Solid carbide,
BTI coated

Flute direction:
Geometry:

Spiral fluted
HPC, EU spacing



Dimensions								z	Order No.
d_1	Tolerance	$d_2\ h6$	l_1	l_2	l_3	l_4	l_5		
3,97	+0,004	6	75	12	36	39	34	4	30585253
3,98	+0,004	6	75	12	36	39	34	4	30585254
3,99	+0,004	6	75	12	36	39	34	4	30585255
4,00	H7	6	75	12	36	39	34	4	30585228
4,01	+0,004	6	75	12	36	39	34	4	30585256
4,02	+0,004	6	75	12	36	39	34	4	30585257
4,03	+0,004	6	75	12	36	39	34	4	30585258
4,50	H7	6	75	12	36	39	34	4	30585229
4,97	+0,004	6	75	12	36	39	35	4	30585259
4,98	+0,004	6	75	12	36	39	35	4	30585260
4,99	+0,004	6	75	12	36	39	35	4	30585261
5,00	H7	6	75	12	36	39	35	4	30585230
5,01	+0,004	6	75	12	36	39	35	4	30585262
5,02	+0,004	6	75	12	36	39	35	4	30585263
5,03	+0,004	6	75	12	36	39	35	4	30585264
5,50	H7	6	75	12	36	39	35	4	30585231
5,97	+0,004	6	75	12	36	39	35	4	30585265
5,98	+0,004	6	75	12	36	39	35	4	30585266
5,99	+0,004	6	75	12	36	39	35	4	30585267
6,00	H7	6	75	12	36	39	35	4	30585232
6,01	+0,004	6	75	12	36	39	35	4	30585268
6,02	+0,004	6	75	12	36	39	35	4	30585269
6,03	+0,004	6	75	12	36	39	35	4	30585270
6,50	H7	8	100	16	36	64	59	6	30585233
7,00	H7	8	100	16	36	64	59	6	30585234
7,50	H7	8	100	16	36	64	60	6	30585235
7,97	+0,004	8	100	16	36	64	60	6	30585271
7,98	+0,004	8	100	16	36	64	60	6	30585272
7,99	+0,004	8	100	16	36	64	60	6	30585273
8,00	H7	8	100	16	36	64	60	6	30585236
8,01	+0,004	8	100	16	36	64	60	6	30585274
8,02	+0,004	8	100	16	36	64	60	6	30585275
8,03	+0,004	8	100	16	36	64	60	6	30585276
8,50	H7	10	100	20	40	60	55	6	30585237
9,00	H7	10	100	20	40	60	55	6	30585238
9,50	H7	10	120	20	40	80	76	6	30585239
9,97	+0,004	10	120	20	40	80	76	6	30585277
9,98	+0,004	10	120	20	40	80	76	6	30585278
9,99	+0,004	10	120	20	40	80	76	6	30585279

HNC-TI | 043272, preferred series for through bore, internal coolant supply

Dimensions								z	Order No.
d ₁	Tolerance	d ₂ h6	l ₁	l ₂	l ₃	l ₄	l ₅		
10,00	H7	10	120	20	40	80	76	6	30585240
10,01	+0,004	10	120	20	40	80	76	6	30585280
10,02	+0,004	10	120	20	40	80	76	6	30585281
10,03	+0,004	10	120	20	40	80	76	6	30585282
10,50	H7	12	120	20	45	75	70	6	30585241
11,00	H7	12	120	20	45	75	70	6	30585242
11,50	H7	12	120	20	45	75	71	6	30585243
11,97	+0,004	12	120	20	45	75	71	6	30585283
11,98	+0,004	12	120	20	45	75	71	6	30585284
11,99	+0,004	12	120	20	45	75	71	6	30585285
12,00	H7	12	120	20	45	75	71	6	30585244
12,01	+0,004	12	120	20	45	75	71	6	30585286
12,02	+0,004	12	120	20	45	75	71	6	30585287
12,03	+0,004	12	120	20	45	75	71	6	30585288
13,00	H7	14	130	22	45	85	80	6	30585245
14,00	H7	14	130	22	45	85	80	6	30585246
15,00	H7	16	130	22	48	82	77	6	30585247
16,00	H7	16	150	25	48	102	97	6	30585248
17,00	H7	18	150	25	48	102	97	8	30585249
18,00	H7	18	150	25	48	102	97	8	30585250
19,00	H7	20	150	25	50	100	95	8	30585251
20,00	H7	20	150	25	50	100	95	8	30585252

Dimensions in mm.

Cutting data see page 367 ff.

Intermediate diameters and special tolerances can be ordered by the overview pages for configurable series on page 38.

HNC-Diamond I 043290

Preferred series for through bore, internal coolant supply

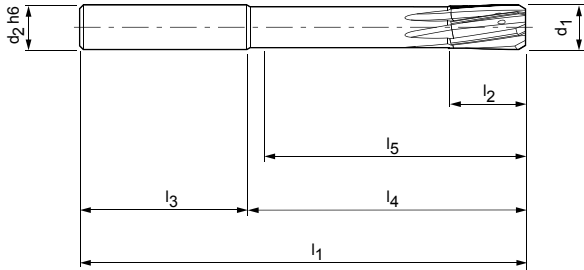

Design:

Diameter:
Cutting direction:
Cutting material:

4,00-20,00 mm
Right-hand cutting
Solid carbide,
Diamond coated

Flute direction:
Geometry:

Spiral fluted
HPC, EU spacing

N	1.1	1.2	1.3	1.4	2.1	2.2	2.3	3.1	4.1	4.2	4.3	C	1.1	1.2	1.3	2.1	3.1	4.1	4.2	4.3	4.4	5.1	5.2
---	-----	-----	-----	-----	-----	-----	-----	-----	-----	-----	-----	---	-----	-----	-----	-----	-----	-----	-----	-----	-----	-----	-----



Dimensions							z	Order No.
$d_1\ H7$	$d_2\ h6$	l_1	l_2	l_3	l_4	l_5		
4,00	6	75	12	36	39	34	4	30476709
4,50	6	75	12	36	39	34	4	30476711
5,00	6	75	12	36	39	35	4	30476714
5,50	6	75	12	36	39	35	4	30476718
6,00	6	75	12	36	39	35	4	30476719
6,50	8	100	16	36	64	59	6	30412526
7,00	8	100	16	36	64	59	6	30476727
7,50	8	100	16	36	64	60	6	30476728
8,00	8	100	16	36	64	60	6	30476729
8,50	10	100	20	40	60	55	6	30476730
9,00	10	100	20	40	60	55	6	30412525
9,50	10	120	20	40	80	76	6	30476732
10,00	10	120	20	40	80	76	6	30412529
10,50	12	120	20	45	75	70	6	30476693
11,00	12	120	20	45	75	70	6	30476694
11,50	12	120	20	45	75	71	6	30476695
12,00	12	120	20	45	75	71	6	30412530
13,00	14	130	22	45	85	80	6	30476696
14,00	14	130	22	45	85	80	6	30466585
15,00	16	130	22	48	82	77	6	30476699
16,00	16	150	25	48	102	97	6	30476702
17,00	18	150	25	48	102	97	8	30476704
18,00	18	150	25	48	102	97	8	30476706
19,00	20	150	25	50	100	95	8	30476707
20,00	20	150	25	50	100	95	8	30412531

Dimensions in mm.

Cutting data see page 367 ff.

Intermediate diameters and special tolerances can be ordered by the overview pages for configurable series on page 38.

HNC-AL I 043250

Preferred series for through bore, internal coolant supply

Design:

Diameter: 4,00-20,00 mm
 Cutting direction: Right-hand cutting
 Cutting material: Solid carbide, BAL coated
 Flute direction: Straight fluted
 Geometry: HPC, EU spacing

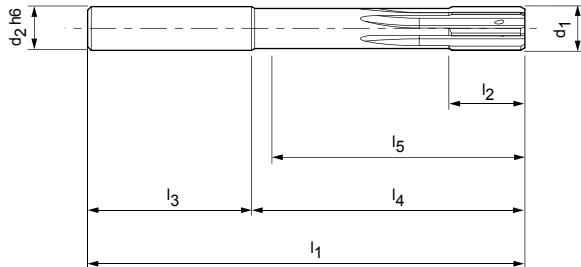

Dimensions							z	Order No.
d_1 H7	d_2 h6	l_1	l_2	l_3	l_4	l_5		
4,00	6	75	12	36	39	34	4	30384144
4,50	6	75	12	36	39	34	4	30384145
5,00	6	75	12	36	39	35	4	30385390
5,50	6	75	12	36	39	35	4	30385391
6,00	6	75	12	36	39	35	4	30385392
6,50	8	100	16	36	64	59	6	30385393
7,00	8	100	16	36	64	59	6	30385394
7,50	8	100	16	36	64	60	6	30385396
8,00	8	100	16	36	64	60	6	30385397
8,50	10	100	20	40	60	55	6	30385398
9,00	10	100	20	40	60	55	6	30385401
9,50	10	120	20	40	80	76	6	30385403
10,00	10	120	20	40	80	76	6	30385405
10,50	12	120	20	45	75	70	6	30385407
11,00	12	120	20	45	75	70	6	30385408
11,50	12	120	20	45	75	71	6	30385409
12,00	12	120	20	45	75	71	6	30385410
13,00	14	130	22	45	85	80	6	30385411
14,00	14	130	22	45	85	80	6	30385413
15,00	16	130	22	48	82	77	6	30385415
16,00	16	150	25	48	102	97	6	30385416
17,00	18	150	25	48	102	97	6	30385418
18,00	18	150	25	48	102	97	6	30385421
19,00	20	150	25	50	100	95	6	30385423
20,00	20	150	25	50	100	95	6	30385425

Dimensions in mm.

Cutting data see page 367 ff.

Intermediate diameters and special tolerances can be ordered by the overview pages for configurable series on page 38.

HNC-HT | 043280

Preferred series for through bore, internal coolant supply

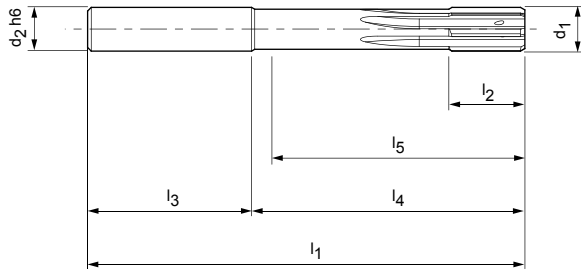

Design:

Diameter:

Cutting direction:

Cutting material:

Flute direction:

Geometry:

3,97-20,00 mm

Right-hand cutting

Solid carbide,

BHV coated

Straight fluted

HPC, EU spacing



Dimensions								z	Order No.
d_1	Tolerance	d_2 h6	l_1	l_2	l_3	l_4	l_5		
3,97	+0,004	6	75	12	36	39	34	4	30300822
3,98	+0,004	6	75	12	36	39	34	4	30300837
3,99	+0,004	6	75	12	36	39	34	4	30300838
4,00	H7	6	75	12	36	39	34	4	30300839
4,01	+0,004	6	75	12	36	39	34	4	30300844
4,02	+0,004	6	75	12	36	39	34	4	30300853
4,03	+0,004	6	75	12	36	39	34	4	30300861
4,50	H7	6	75	12	36	39	34	4	30300865
4,97	+0,004	6	75	12	36	39	35	4	30300866
4,98	+0,004	6	75	12	36	39	35	4	30300867
4,99	+0,004	6	75	12	36	39	35	4	30300868
5,00	H7	6	75	12	36	39	35	4	30300869
5,01	+0,004	6	75	12	36	39	35	4	30300871
5,02	+0,004	6	75	12	36	39	35	4	30300873
5,03	+0,004	6	75	12	36	39	35	4	30300875
5,50	H7	6	75	12	36	39	35	4	30300876
5,97	+0,004	6	75	12	36	39	35	4	30300877
5,98	+0,004	6	75	12	36	39	35	4	30300878
5,99	+0,004	6	75	12	36	39	35	4	30300879
6,00	H7	6	75	12	36	39	35	4	30300882
6,01	+0,004	6	75	12	36	39	35	4	30300884
6,02	+0,004	6	75	12	36	39	35	4	30300885
6,03	+0,004	6	75	12	36	39	35	4	30300911
6,50	H7	8	100	16	36	64	59	6	30300912
7,00	H7	8	100	16	36	64	59	6	30300913
7,50	H7	8	100	16	36	64	60	6	30300914
7,97	+0,004	8	100	16	36	64	60	6	30300955
7,98	+0,004	8	100	16	36	64	60	6	30300957
7,99	+0,004	8	100	16	36	64	60	6	30300959
8,00	H7	8	100	16	36	64	60	6	30228276
8,01	+0,004	8	100	16	36	64	60	6	30300960
8,02	+0,004	8	100	16	36	64	60	6	30300961
8,03	+0,004	8	100	16	36	64	60	6	30300962
8,50	H7	10	100	20	40	60	55	6	30300963
9,00	H7	10	100	20	40	60	55	6	30300964
9,50	H7	10	120	20	40	80	76	6	30300965
9,97	+0,004	10	120	20	40	80	76	6	30300966
9,98	+0,004	10	120	20	40	80	76	6	30300967
9,99	+0,004	10	120	20	40	80	76	6	30300968

HNC-HT | 043280, preferred series for through bore, internal coolant supply

Dimensions								z	Order No.
d ₁	Tolerance	d ₂ h6	l ₁	l ₂	l ₃	l ₄	l ₅		
10,00	H7	10	120	20	40	80	76	6	30300972
10,01	+0,004	10	120	20	40	80	76	6	30300974
10,02	+0,004	10	120	20	40	80	76	6	30300976
10,03	+0,004	10	120	20	40	80	76	6	30300977
10,50	H7	12	120	20	45	75	70	6	30300979
11,00	H7	12	120	20	45	75	70	6	30300980
11,50	H7	12	120	20	45	75	71	6	30300982
11,97	+0,004	12	120	20	45	75	71	6	30300983
11,98	+0,004	12	120	20	45	75	71	6	30300985
11,99	+0,004	12	120	20	45	75	71	6	30300986
12,00	H7	12	120	20	45	75	71	6	30228277
12,01	+0,004	12	120	20	45	75	71	6	30300994
12,02	+0,004	12	120	20	45	75	71	6	30300995
12,03	+0,004	12	120	20	45	75	71	6	30300996
13,00	H7	14	130	22	45	85	80	6	30300998
14,00	H7	14	130	22	45	85	80	6	30300999
15,00	H7	16	130	22	48	82	77	6	30301001
16,00	H7	16	150	25	48	102	97	6	30228279
17,00	H7	18	150	25	48	102	97	6	30301002
18,00	H7	18	150	25	48	102	97	6	30301003
19,00	H7	20	150	25	50	100	95	6	30301004
20,00	H7	20	150	25	50	100	95	6	30301005

Dimensions in mm.

Cutting data see page 367 ff.

If necessary the reamers diameter must be adjusted to the hardening process or to the components temper. Please ask us for advice!

Intermediate diameters and special tolerances can be ordered by the overview pages for configurable series on page 38.

HCS I 040360

Preferred series for through bore, internal coolant supply

Design:

Diameter:
Cutting direction:
Cutting material:
Flute direction:
Geometry:

3,97-12,03 mm
Right-hand cutting
Cermet, uncoated
Spiral fluted
HPC, EU spacing

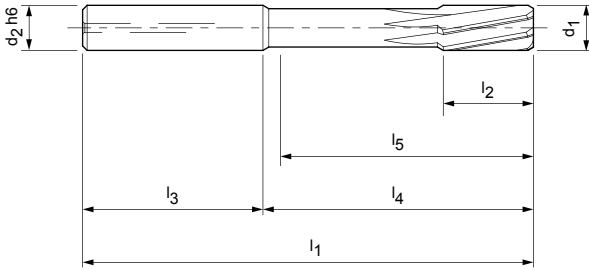

Dimensions								z	Order No.
d_1	Tolerance	$d_2 h6$	l_1	l_2	l_3	l_4	l_5		
3,97	+0,004	6	70	10	36	34	29	4	30194481
3,98	+0,004	6	70	10	36	34	29	4	30194756
3,99	+0,004	6	70	10	36	34	29	4	30194757
4,00	H7	6	70	10	36	34	29	4	30194758
4,01	+0,004	6	70	10	36	34	29	4	30194759
4,02	+0,004	6	70	10	36	34	29	4	30194761
4,03	+0,004	6	70	10	36	34	29	4	30194762
4,50	H7	6	70	10	36	34	29	4	30194763
4,97	+0,004	6	70	10	36	34	29	4	30194779
4,98	+0,004	6	70	10	36	34	29	4	30194801
4,99	+0,004	6	70	10	36	34	29	4	30194802
5,00	H7	6	70	10	36	34	29	4	30194803
5,01	+0,004	6	70	10	36	34	29	4	30194804
5,02	+0,004	6	70	10	36	34	29	4	30194805
5,03	+0,004	6	70	10	36	34	29	4	30194808
5,50	H7	6	70	10	36	34	29	4	30194809
5,97	+0,004	6	70	10	36	34	29	6	30194810
5,98	+0,004	6	70	10	36	34	29	6	30194813
5,99	+0,004	6	70	10	36	34	29	6	30194815
6,00	H7	6	70	10	36	34	29	6	30194816
6,01	+0,004	6	70	10	36	34	29	6	30194817
6,02	+0,004	6	70	10	36	34	29	6	30194818
6,03	+0,004	6	70	10	36	34	29	6	30194819
6,50	H7	8	75	15	36	39	34	6	30194820
7,00	H7	8	75	15	36	39	34	6	30194822
7,50	H7	8	75	15	36	39	34	6	30194823
7,97	+0,004	8	75	15	36	39	34	6	30194825
7,98	+0,004	8	75	15	36	39	34	6	30194827
7,99	+0,004	8	75	15	36	39	34	6	30194828
8,00	H7	8	75	15	36	39	34	6	30194829
8,01	+0,004	8	75	15	36	39	34	6	30194830
8,02	+0,004	8	75	15	36	39	34	6	30194832
8,03	+0,004	8	75	15	36	39	34	6	30194833
8,50	H7	10	75	15	40	35	30	6	30194834
9,00	H7	10	75	15	40	35	30	6	30194835
9,50	H7	10	75	15	40	35	30	6	30194837
9,97	+0,004	10	100	20	40	60	55	6	30194838
9,98	+0,004	10	100	20	40	60	55	6	30194840

HCS I 040360, preferred series for through bore, internal coolant supply

Dimensions								z	Order No.
d ₁	Tolerance	d ₂ h6	l ₁	l ₂	l ₃	l ₄	l ₅		
9,99	+0,004	10	100	20	40	60	55	6	30194842
10,00	H7	10	100	20	40	60	55	6	30194843
10,01	+0,004	10	100	20	40	60	55	6	30194844
10,02	+0,004	10	100	20	40	60	55	6	30194845
10,03	+0,004	10	100	20	40	60	55	6	30194846
10,50	H7	12	100	20	45	55	50	6	30194847
11,00	H7	12	100	20	45	55	50	6	30194848
11,50	H7	12	100	20	45	55	50	6	30194849
11,97	+0,004	12	100	20	45	55	50	6	30194851
11,98	+0,004	12	100	20	45	55	50	6	30194852
11,99	+0,004	12	100	20	45	55	50	6	30194853
12,00	H7	12	100	20	45	55	50	6	30194854
12,01	+0,004	12	100	20	45	55	50	6	30194855
12,02	+0,004	12	100	20	45	55	50	6	30194856
12,03	+0,004	12	100	20	45	55	50	6	30194857

Dimensions in mm.

Cutting data see page 367 ff.

Intermediate diameters and special tolerances can be ordered by the overview pages for configurable series on page 38.

HNC reamers, overview

Configurable series for through bore with internal coolant supply

Design: 040260
Diameter: 2,800-20,200 mm
Cutting direction: Right-hand cutting
Cutting material: Solid carbide, uncoated
Flute direction: Spiral fluted
Geometry: HPC, EU spacing

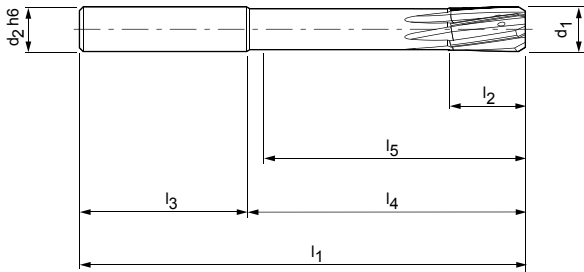

HNC, HNC-AL, HNC-Speed, HNC-VA, HNC-TI, HNC-HT, HNC-Diamond

	P	1	2	3	4	5	6	M	1	2	3	K	1	2	3	N	1	2	3	4	S	1	2	3	4	5	H	1.1	1.2	2
040260																														
043250																														
043260																														
043270																														
043272																														
043280																														

	N	1.1	1.2	1.3	1.4	2.1	2.2	2.3	3.1	4.1	4.2	4.3	1.1	1.2	1.3	2.1	3.1	4.1	4.2	4.3	4.4	5.1	5.2
043290																							

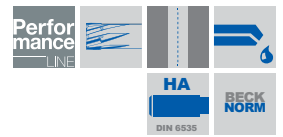

HCS I 040360

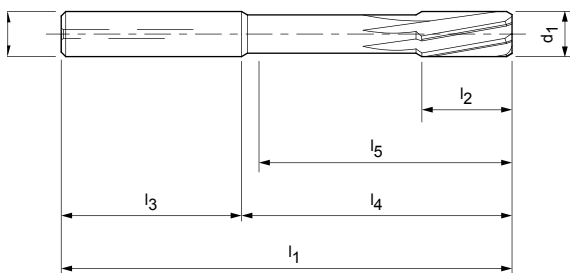

Design:
Diameter: 3,701-12,100 mm
Cutting direction: Right-hand cutting
Cutting material: Cermet, uncoated
Flute direction: Spiral fluted
Geometry: HPC, EU spacing

	P	1	2	3	4	5	6	M	1	2	3	K	1	2	3	N	1	2	3	4	S	1	2	3	4	5	H	1	2
040360																													



Ordering example:

1. BECK product code

0 4 3 2 6 0

BECK product code

2. Diameter

- 1 2 . 2 0 0

Hyphen

Bore diameter

3. Tolerance

H 7

IT or tolerance in µm

043250	043260	043270	043272	043280	043290
3,701-20,200 mm Right-hand cutting Solid carbide, BAL coated Straight fluted HPC, EU spacing	2,800-20,200 mm Right-hand cutting Solid carbide, BSP coated Spiral fluted HPC, EU spacing	3,701-20,200 mm Right-hand cutting Solid carbide, BVA coated Spiral fluted HPC, EU spacing	3,701-20,200 mm Right-hand cutting Solid carbide, BTI coated Spiral fluted HPC, EU spacing	3,701-20,200 mm Right-hand cutting Solid carbide, BHV coated Straight fluted HPC, EU spacing	3,701-20,200 mm Right-hand cutting Solid carbide, Diamond coated Spiral fluted HPC, EU spacing

HNC, HNC-AL, HNC-Speed, HNC-VA, HNC-TI, HNC-HT, HNC-Diamond

Dimensions							z
d ₁	d ₂	l ₁	l ₂	l ₃	l ₄	l ₅	
2,800-3,030	4	65	12	28	37	34	4
3,031-3,350	4	65	12	28	37	34	4
3,351-3,700	4	65	12	28	37	34	4
3,701-4,200	6	75	12	36	39	34	4
4,201-4,700	6	75	12	36	39	34	4
4,701-5,200	6	75	12	36	39	35	4
5,201-5,700	6	75	12	36	39	35	4
5,701-6,200	6	75	12	36	39	35	4
6,201-6,700	8	100	16	36	64	59	6
6,701-7,200	8	100	16	36	64	59	6
7,201-7,700	8	100	16	36	64	60	6
7,701-8,200	8	100	16	36	64	60	6
8,201-8,700	10	100	20	40	60	55	6
8,701-9,200	10	100	20	40	60	55	6
9,201-9,700	10	120	20	40	80	76	6
9,701-10,200	10	120	20	40	80	76	6
10,201-10,700	12	120	20	45	75	70	6
10,701-11,200	12	120	20	45	75	70	6
11,201-11,700	12	120	20	45	75	71	6
11,701-12,200	12	120	20	45	75	71	6
12,201-13,200	14	130	22	45	85	80	6
13,201-14,200	14	130	22	45	85	80	6
14,201-15,200	16	130	22	48	82	77	6
15,201-16,200	16	150	25	48	102	97	6
16,201-17,200	18	150	25	48	102	97	8/6
17,201-18,200	18	150	25	48	102	97	8/6
18,201-19,200	20	150	25	50	100	95	8/6
19,201-20,200	20	150	25	50	100	95	8/6

HCS I 040360

Dimensions							z
d ₁	d ₂	l ₁	l ₂	l ₃	l ₄	l ₅	
3,701-4,200	6	70	10	36	34	29	4
4,201-4,700	6	70	10	36	34	29	4
4,701-5,200	6	70	10	36	34	29	4
5,201-5,700	6	70	10	36	34	29	4
5,701-6,200	6	70	10	36	34	29	6
6,201-6,700	8	75	15	36	39	34	6
6,701-7,200	8	75	15	36	39	34	6
7,201-7,700	8	75	15	36	39	34	6
7,701-8,200	8	75	15	36	39	34	6
8,201-8,700	10	75	15	40	35	30	6
8,701-9,200	10	75	15	40	35	30	6
9,201-9,700	10	75	15	40	35	30	6
9,701-10,200	10	100	20	40	60	55	6
10,201-10,700	12	100	20	45	55	50	6
10,701-11,200	12	100	20	45	55	50	6
11,201-11,700	12	100	20	45	55	50	6
11,701-12,100	12	100	20	45	55	50	6

Dimensions in mm.
Cutting data see page 367 ff.

PcBN reamer I 040356

Preferred series for through bore, internal coolant supply

Design:

Diameter:
Cutting direction:
Cutting material:
Flute direction:
Geometry:

3,00-10,00 mm
Right-hand cutting
PcBN tipped head
Straight fluted
HPC, EU spacing

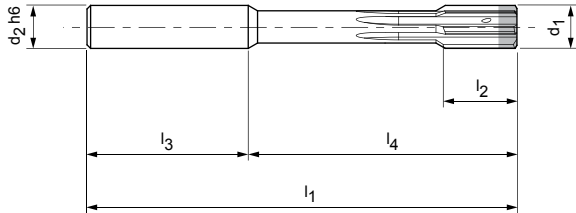

Dimensions						z	Order No.
d_1 H7	d_2 h6	l_1	l_2	l_3	l_4		
3,00	4	65	12	28	37	6	30601315
3,50	4	65	12	28	37	6	30601316
4,00	6	75	12	36	39	6	30556056
4,50	6	75	12	36	39	6	30601317
5,00	6	75	12	36	39	6	30601318
5,50	6	75	12	36	39	6	30601319
6,00	6	75	12	36	39	8	30591461
6,50	8	100	16	36	64	8	30601320
7,00	8	100	16	36	64	8	30601321
7,50	8	100	16	36	64	8	30601322
8,00	8	100	16	36	64	10	30589906
8,50	10	100	16	40	60	10	30601323
9,00	10	100	16	40	60	10	30601324
9,50	10	120	20	40	80	10	30601325
10,00	10	120	20	40	80	10	30601327

Dimensions in mm.
Cutting data see page 367 ff.
PcBN reamers in the \varnothing range 1-3 mm without internal coolant supply on request.

PcBN reamer I 040356, overview

Configurable series for through bore, internal coolant supply

Design:

Diameter: 3,001-10,200 mm
 Cutting direction: Right-hand cutting
 Cutting material: PcBN tipped head
 Flute direction: Straight fluted
 Geometry: HPC, EU spacing

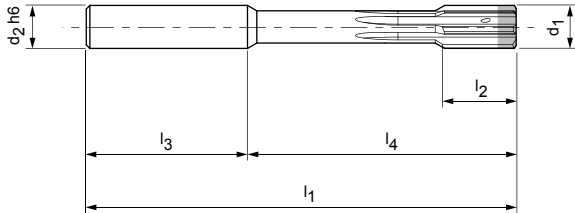

Dimensions						z
d_1	d_2	l_1	l_2	l_3	l_4	
3,001-3,210	4	65	12	28	37	6
3,211-3,710	4	65	12	28	37	6
3,711-4,210	6	75	12	36	39	6
4,211-4,710	6	75	12	36	39	6
4,711-5,210	6	75	12	36	39	6
5,211-5,710	6	75	12	36	39	6
5,711-6,210	6	75	12	36	39	8
6,211-6,710	8	100	16	36	64	8
6,711-7,210	8	100	16	36	64	8
7,211-7,710	8	100	16	36	64	8
7,711-8,210	8	100	16	36	64	10
8,211-8,710	10	100	16	40	60	10
8,711-9,210	10	100	16	40	60	10
9,211-9,710	10	120	20	40	80	10
9,711-10,200	10	120	20	40	80	10

Dimensions in mm.

Cutting data see page 367 ff.

PcBN reamers in the \varnothing range 1-3 mm without internal coolant supply on request.

HNC I 040261

Preferred series for blind bore, internal coolant supply

Design:

Diameter:
Cutting direction:
Cutting material:

3,00-20,00 mm
Right-hand cutting
Solid carbide,
uncoated
Straight fluted
HPC, EU spacing

Flute direction:
Geometry:

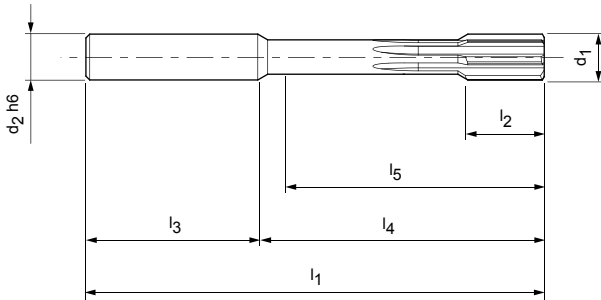

Dimensions								z	Order No.
d_1	Tolerance	$d_2\ h6$	l_1	l_2	l_3	l_4	l_5		
3,00	H7	4	65	12	28	37	33	4	30402436
3,20	H7	4	65	12	28	37	33	4	30402437
3,50	H7	4	65	12	28	37	33	4	30402440
3,97	+0,004	6	75	12	36	39	34	4	30131314
3,98	+0,004	6	75	12	36	39	34	4	30131316
3,99	+0,004	6	75	12	36	39	34	4	30131318
4,00	H7	6	75	12	36	39	34	4	30131320
4,01	+0,004	6	75	12	36	39	34	4	30131322
4,02	+0,004	6	75	12	36	39	34	4	30131324
4,03	+0,004	6	75	12	36	39	34	4	30131326
4,50	H7	6	75	12	36	39	34	4	30131328
4,97	+0,004	6	75	12	36	39	34	4	30131330
4,98	+0,004	6	75	12	36	39	34	4	30131332
4,99	+0,004	6	75	12	36	39	34	4	30131334
5,00	H7	6	75	12	36	39	34	4	30131336
5,01	+0,004	6	75	12	36	39	34	4	30131338
5,02	+0,004	6	75	12	36	39	34	4	30131340
5,03	+0,004	6	75	12	36	39	34	4	30131342
5,50	H7	6	75	12	36	39	34	4	30131344
5,97	+0,004	6	75	12	36	39	34	4	30131346
5,98	+0,004	6	75	12	36	39	34	4	30131348
5,99	+0,004	6	75	12	36	39	34	4	30131350
6,00	H7	6	75	12	36	39	34	4	30131352
6,01	+0,004	6	75	12	36	39	34	4	30131354
6,02	+0,004	6	75	12	36	39	34	4	30131356
6,03	+0,004	6	75	12	36	39	34	4	30131358
6,50	H7	8	100	16	36	64	58	6	30131360
7,00	H7	8	100	16	36	64	58	6	30131362
7,50	H7	8	100	16	36	64	58	6	30131364
7,97	+0,004	8	100	16	36	64	58	6	30131366
7,98	+0,004	8	100	16	36	64	58	6	30131368
7,99	+0,004	8	100	16	36	64	58	6	30131370
8,00	H7	8	100	16	36	64	58	6	30131372
8,01	+0,004	8	100	16	36	64	58	6	30131374
8,02	+0,004	8	100	16	36	64	58	6	30131376
8,03	+0,004	8	100	16	36	64	58	6	30131378
8,50	H7	10	100	20	40	60	54	6	30131380
9,00	H7	10	100	20	40	60	54	6	30131382
9,50	H7	10	120	20	40	80	74	6	30131384

HNC I 040261, preferred series for blind bore, internal coolant supply

Dimensions								z	Order No.
d ₁	Tolerance	d ₂ h6	l ₁	l ₂	l ₃	l ₄	l ₅		
9,97	+0,004	10	120	20	40	80	74	6	30131386
9,98	+0,004	10	120	20	40	80	74	6	30131388
9,99	+0,004	10	120	20	40	80	74	6	30131390
10,00	H7	10	120	20	40	80	74	6	30131392
10,01	+0,004	10	120	20	40	80	74	6	30131394
10,02	+0,004	10	120	20	40	80	74	6	30131396
10,03	+0,004	10	120	20	40	80	74	6	30131398
10,50	H7	12	120	20	45	75	68	6	30131400
11,00	H7	12	120	20	45	75	68	6	30131402
11,50	H7	12	120	20	45	75	68	6	30131404
11,97	+0,004	12	120	20	45	75	68	6	30131406
11,98	+0,004	12	120	20	45	75	68	6	30131408
11,99	+0,004	12	120	20	45	75	68	6	30131410
12,00	H7	12	120	20	45	75	68	6	30131412
12,01	+0,004	12	120	20	45	75	68	6	30131414
12,02	+0,004	12	120	20	45	75	68	6	30131416
12,03	+0,004	12	120	20	45	75	68	6	30131418
13,00	H7	14	130	22	45	85	78	6	30131420
14,00	H7	14	130	22	45	85	78	6	30131422
15,00	H7	16	130	22	48	82	75	6	30131424
16,00	H7	16	150	25	48	102	95	6	30131426
17,00	H7	18	150	25	48	102	95	6	30131428
18,00	H7	18	150	25	48	102	95	6	30131430
19,00	H7	20	150	25	50	100	92	6	30131432
20,00	H7	20	150	25	50	100	92	6	30131434

Dimensions in mm.

Cutting data see page 367 ff.

Intermediate diameters and special tolerances can be ordered by the overview pages for configurable series on page 54.

HNC-Speed I 043261

Preferred series for blind bore, internal coolant supply

Design:

Diameter:
Cutting direction:
Cutting material:

3,00-20,00 mm
Right-hand cutting
Solid carbide,
BSP coated
Straight fluted
HPC, EU spacing

Flute direction:
Geometry:

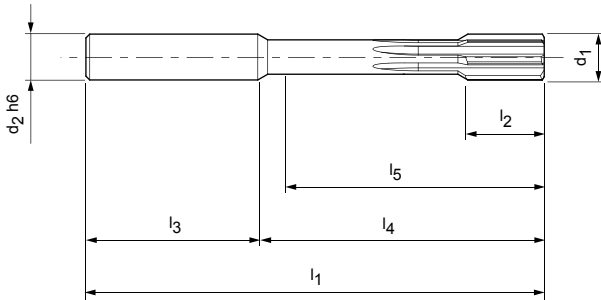

Dimensions								z	Order No.
d_1	Tolerance	$d_2\ h6$	l_1	l_2	l_3	l_4	l_5		
3,00	H7	4	65	12	28	37	33	4	30402456
3,20	H7	4	65	12	28	37	33	4	30402457
3,50	H7	4	65	12	28	37	33	4	30402458
3,97	+0,004	6	75	12	36	39	34	4	30131558
3,98	+0,004	6	75	12	36	39	34	4	30131560
3,99	+0,004	6	75	12	36	39	34	4	30131562
4,00	H7	6	75	12	36	39	34	4	30131564
4,01	+0,004	6	75	12	36	39	34	4	30131566
4,02	+0,004	6	75	12	36	39	34	4	30131568
4,03	+0,004	6	75	12	36	39	34	4	30131570
4,50	H7	6	75	12	36	39	34	4	30131572
4,97	+0,004	6	75	12	36	39	34	4	30131574
4,98	+0,004	6	75	12	36	39	34	4	30131576
4,99	+0,004	6	75	12	36	39	34	4	30131578
5,00	H7	6	75	12	36	39	34	4	30131580
5,01	+0,004	6	75	12	36	39	34	4	30131582
5,02	+0,004	6	75	12	36	39	34	4	30131584
5,03	+0,004	6	75	12	36	39	34	4	30131586
5,50	H7	6	75	12	36	39	34	4	30131588
5,97	+0,004	6	75	12	36	39	34	4	30131590
5,98	+0,004	6	75	12	36	39	34	4	30131592
5,99	+0,004	6	75	12	36	39	34	4	30131594
6,00	H7	6	75	12	36	39	34	4	30131596
6,01	+0,004	6	75	12	36	39	34	4	30131598
6,02	+0,004	6	75	12	36	39	34	4	30131600
6,03	+0,004	6	75	12	36	39	34	4	30131602
6,50	H7	8	100	16	36	64	58	6	30131604
7,00	H7	8	100	16	36	64	58	6	30131606
7,50	H7	8	100	16	36	64	58	6	30131608
7,97	+0,004	8	100	16	36	64	58	6	30131610
7,98	+0,004	8	100	16	36	64	58	6	30131612
7,99	+0,004	8	100	16	36	64	58	6	30131614
8,00	H7	8	100	16	36	64	58	6	30131616
8,01	+0,004	8	100	16	36	64	58	6	30131618
8,02	+0,004	8	100	16	36	64	58	6	30131620
8,03	+0,004	8	100	16	36	64	58	6	30131622
8,50	H7	10	100	20	40	60	54	6	30131624
9,00	H7	10	100	20	40	60	54	6	30131626
9,50	H7	10	120	20	40	80	74	6	30131628

HNC-Speed I 043261, preferred series for blind bore, internal coolant supply

Dimensions								z	Order No.
d ₁	Tolerance	d ₂ h6	l ₁	l ₂	l ₃	l ₄	l ₅		
9,97	+0,004	10	120	20	40	80	74	6	30131630
9,98	+0,004	10	120	20	40	80	74	6	30131632
9,99	+0,004	10	120	20	40	80	74	6	30131634
10,00	H7	10	120	20	40	80	74	6	30131636
10,01	+0,004	10	120	20	40	80	74	6	30131638
10,02	+0,004	10	120	20	40	80	74	6	30131640
10,03	+0,004	10	120	20	40	80	74	6	30131642
10,50	H7	12	120	20	45	75	68	6	30131644
11,00	H7	12	120	20	45	75	68	6	30131646
11,50	H7	12	120	20	45	75	68	6	30131648
11,97	+0,004	12	120	20	45	75	68	6	30131650
11,98	+0,004	12	120	20	45	75	68	6	30131652
11,99	+0,004	12	120	20	45	75	68	6	30131654
12,00	H7	12	120	20	45	75	68	6	30131656
12,01	+0,004	12	120	20	45	75	68	6	30131658
12,02	+0,004	12	120	20	45	75	68	6	30131660
12,03	+0,004	12	120	20	45	75	68	6	30131662
13,00	H7	14	130	22	45	85	78	6	30131664
14,00	H7	14	130	22	45	85	78	6	30131666
15,00	H7	16	130	22	48	82	75	6	30131668
16,00	H7	16	150	25	48	102	95	6	30131670
17,00	H7	18	150	25	48	102	95	6	30131672
18,00	H7	18	150	25	48	102	95	6	30131674
19,00	H7	20	150	25	50	100	92	6	30131676
20,00	H7	20	150	25	50	100	92	6	30131678

Dimensions in mm.

Cutting data see page 367 ff.

Intermediate diameters and special tolerances can be ordered by the overview pages for configurable series on page 54.

HNC-VA I 043271

Preferred series for blind bore, internal coolant supply

Design:

Diameter:
Cutting direction:
Cutting material:

3,97-20,00 mm
Right-hand cutting
Solid carbide,
BVA coated
Straight fluted
HPC, EU spacing

Flute direction:
Geometry:

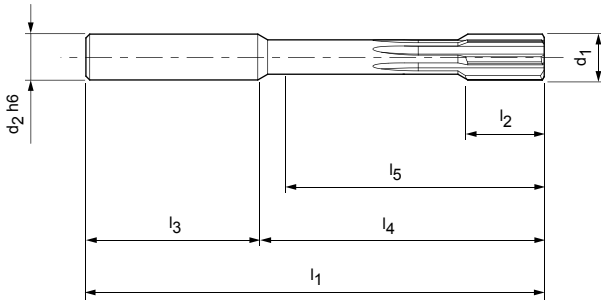

Dimensions								z	Order No.
d ₁	Tolerance	d ₂ h6	l ₁	l ₂	l ₃	l ₄	l ₅		
3,97	+0,004	6	75	12	36	39	34	4	30131802
3,98	+0,004	6	75	12	36	39	34	4	30131804
3,99	+0,004	6	75	12	36	39	34	4	30131806
4,00	H7	6	75	12	36	39	34	4	30131808
4,01	+0,004	6	75	12	36	39	34	4	30131810
4,02	+0,004	6	75	12	36	39	34	4	30131812
4,03	+0,004	6	75	12	36	39	34	4	30131814
4,50	H7	6	75	12	36	39	34	4	30131816
4,97	+0,004	6	75	12	36	39	34	4	30131818
4,98	+0,004	6	75	12	36	39	34	4	30131820
4,99	+0,004	6	75	12	36	39	34	4	30131822
5,00	H7	6	75	12	36	39	34	4	30131824
5,01	+0,004	6	75	12	36	39	34	4	30131826
5,02	+0,004	6	75	12	36	39	34	4	30131828
5,03	+0,004	6	75	12	36	39	34	4	30131830
5,50	H7	6	75	12	36	39	34	4	30131832
5,97	+0,004	6	75	12	36	39	34	4	30131834
5,98	+0,004	6	75	12	36	39	34	4	30131836
5,99	+0,004	6	75	12	36	39	34	4	30131838
6,00	H7	6	75	12	36	39	34	4	30131840
6,01	+0,004	6	75	12	36	39	34	4	30131842
6,02	+0,004	6	75	12	36	39	34	4	30131844
6,03	+0,004	6	75	12	36	39	34	4	30131846
6,50	H7	8	100	16	36	64	58	6	30131848
7,00	H7	8	100	16	36	64	58	6	30131850
7,50	H7	8	100	16	36	64	58	6	30131852
7,97	+0,004	8	100	16	36	64	58	6	30131854
7,98	+0,004	8	100	16	36	64	58	6	30131856
7,99	+0,004	8	100	16	36	64	58	6	30131858
8,00	H7	8	100	16	36	64	58	6	30131860
8,01	+0,004	8	100	16	36	64	58	6	30131862
8,02	+0,004	8	100	16	36	64	58	6	30131864
8,03	+0,004	8	100	16	36	64	58	6	30131866
8,50	H7	10	100	20	40	60	54	6	30131868
9,00	H7	10	100	20	40	60	54	6	30131870
9,50	H7	10	120	20	40	80	74	6	30131872
9,97	+0,004	10	120	20	40	80	74	6	30131874
9,98	+0,004	10	120	20	40	80	74	6	30131876
9,99	+0,004	10	120	20	40	80	74	6	30131878

HNC-VA I 043271, preferred series for blind bore, internal coolant supply

Dimensions								z	Order No.
d ₁	Tolerance	d ₂ h6	l ₁	l ₂	l ₃	l ₄	l ₅		
10,00	H7	10	120	20	40	80	74	6	30131880
10,01	+0,004	10	120	20	40	80	74	6	30131882
10,02	+0,004	10	120	20	40	80	74	6	30131884
10,03	+0,004	10	120	20	40	80	74	6	30131886
10,50	H7	12	120	20	45	75	68	6	30131888
11,00	H7	12	120	20	45	75	68	6	30131890
11,50	H7	12	120	20	45	75	68	6	30131892
11,97	+0,004	12	120	20	45	75	68	6	30131894
11,98	+0,004	12	120	20	45	75	68	6	30131896
11,99	+0,004	12	120	20	45	75	68	6	30131898
12,00	H7	12	120	20	45	75	68	6	30131900
12,01	+0,004	12	120	20	45	75	68	6	30131902
12,02	+0,004	12	120	20	45	75	68	6	30131904
12,03	+0,004	12	120	20	45	75	68	6	30131906
13,00	H7	14	130	22	45	85	78	6	30131908
14,00	H7	14	130	22	45	85	78	6	30131910
15,00	H7	16	130	22	48	82	75	6	30131912
16,00	H7	16	150	25	48	102	95	6	30131914
17,00	H7	18	150	25	48	102	95	6	30131916
18,00	H7	18	150	25	48	102	95	6	30131918
19,00	H7	20	150	25	50	100	92	6	30131920
20,00	H7	20	150	25	50	100	92	6	30131922

Dimensions in mm.

Cutting data see page 367 ff.

Intermediate diameters and special tolerances can be ordered by the overview pages for configurable series on page 54.

HNC-TI | 043273

Preferred series for blind bore, internal coolant supply

Design:

Diameter:
Cutting direction:
Cutting material:

3,97-20,00 mm
Right-hand cutting
Solid carbide,
BTI coated
Straight fluted
HPC, EU spacing

Flute direction:
Geometry:

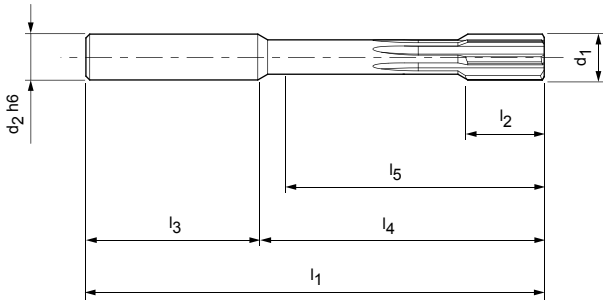

Dimensions								z	Order No.
d ₁	Tolerance	d ₂ h6	l ₁	l ₂	l ₃	l ₄	l ₅		
3,97	+0,004	6	75	12	36	39	34	4	30585314
3,98	+0,004	6	75	12	36	39	34	4	30585315
3,99	+0,004	6	75	12	36	39	34	4	30585316
4,00	H7	6	75	12	36	39	34	4	30585289
4,01	+0,004	6	75	12	36	39	34	4	30585317
4,02	+0,004	6	75	12	36	39	34	4	30585318
4,03	+0,004	6	75	12	36	39	34	4	30585319
4,50	H7	6	75	12	36	39	34	4	30585290
4,97	+0,004	6	75	12	36	39	34	4	30585320
4,98	+0,004	6	75	12	36	39	34	4	30585321
4,99	+0,004	6	75	12	36	39	34	4	30585322
5,00	H7	6	75	12	36	39	34	4	30585291
5,01	+0,004	6	75	12	36	39	34	4	30585323
5,02	+0,004	6	75	12	36	39	34	4	30585324
5,03	+0,004	6	75	12	36	39	34	4	30585325
5,50	H7	6	75	12	36	39	34	4	30585292
5,97	+0,004	6	75	12	36	39	34	4	30585326
5,98	+0,004	6	75	12	36	39	34	4	30585327
5,99	+0,004	6	75	12	36	39	34	4	30585328
6,00	H7	6	75	12	36	39	34	4	30585293
6,01	+0,004	6	75	12	36	39	34	4	30585329
6,02	+0,004	6	75	12	36	39	34	4	30585330
6,03	+0,004	6	75	12	36	39	34	4	30585331
6,50	H7	8	100	16	36	64	58	6	30585294
7,00	H7	8	100	16	36	64	58	6	30585295
7,50	H7	8	100	16	36	64	58	6	30585296
7,97	+0,004	8	100	16	36	64	58	6	30585332
7,98	+0,004	8	100	16	36	64	58	6	30585333
7,99	+0,004	8	100	16	36	64	58	6	30585334
8,00	H7	8	100	16	36	64	58	6	30585297
8,01	+0,004	8	100	16	36	64	58	6	30585335
8,02	+0,004	8	100	16	36	64	58	6	30585336
8,03	+0,004	8	100	16	36	64	58	6	30585337
8,50	H7	10	100	20	40	60	54	6	30585298
9,00	H7	10	100	20	40	60	54	6	30585299
9,50	H7	10	120	20	40	80	74	6	30585300
9,97	+0,004	10	120	20	40	80	74	6	30585338
9,98	+0,004	10	120	20	40	80	74	6	30585339
9,99	+0,004	10	120	20	40	80	74	6	30585340

HNC-TI | 043273, preferred series for blind bore, internal coolant supply

Dimensions								z	Order No.
d ₁	Tolerance	d ₂ h6	l ₁	l ₂	l ₃	l ₄	l ₅		
10,00	H7	10	120	20	40	80	74	6	30585301
10,01	+0,004	10	120	20	40	80	74	6	30585341
10,02	+0,004	10	120	20	40	80	74	6	30585342
10,03	+0,004	10	120	20	40	80	74	6	30585343
10,50	H7	12	120	20	45	75	68	6	30585302
11,00	H7	12	120	20	45	75	68	6	30585303
11,50	H7	12	120	20	45	75	68	6	30585304
11,97	+0,004	12	120	20	45	75	68	6	30585344
11,98	+0,004	12	120	20	45	75	68	6	30585345
11,99	+0,004	12	120	20	45	75	68	6	30585346
12,00	H7	12	120	20	45	75	68	6	30585305
12,01	+0,004	12	120	20	45	75	68	6	30585347
12,02	+0,004	12	120	20	45	75	68	6	30585348
12,03	+0,004	12	120	20	45	75	68	6	30585349
13,00	H7	14	130	22	45	85	78	6	30585306
14,00	H7	14	130	22	45	85	78	6	30585307
15,00	H7	16	130	22	48	82	75	6	30585308
16,00	H7	16	150	25	48	102	95	6	30585309
17,00	H7	18	150	25	48	102	95	6	30585310
18,00	H7	18	150	25	48	102	95	6	30585311
19,00	H7	20	150	25	50	100	92	6	30585312
20,00	H7	20	150	25	50	100	92	6	30585313

Dimensions in mm.

Cutting data see page 367 ff.

Intermediate diameters and special tolerances can be ordered by the overview pages for configurable series on page 54.

HNC-Diamond I 043291

Preferred series for blind bore, internal coolant supply

Design:

Diameter:
Cutting direction:
Cutting material:

4,00-20,00 mm
Right-hand cutting
Solid carbide,
diamond coated
Straight fluted
HPC, EU spacing

Flute direction:
Geometry:

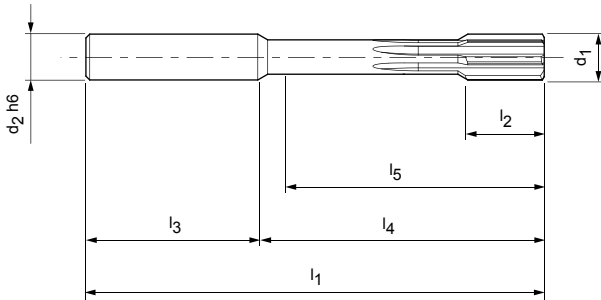

N	1.1	1.2	1.3	1.4	2.1	2.2	2.3	3.1	4.1	4.2	4.3	C	1.1	1.2	1.3	2.1	3.1	4.1	4.2	4.3	4.4	5.1	5.2
---	-----	-----	-----	-----	-----	-----	-----	-----	-----	-----	-----	---	-----	-----	-----	-----	-----	-----	-----	-----	-----	-----	-----



Dimensions							z	Order No.
$d_1\ H7$	$d_2\ h6$	l_1	l_2	l_3	l_4	l_5		
4,00	6	75	12	36	39	34	4	30601845
4,50	6	75	12	36	39	34	4	30495398
5,00	6	75	12	36	39	34	4	30601846
5,50	6	75	12	36	39	34	4	30601847
6,00	6	75	12	36	39	34	4	30498850
6,50	8	100	16	36	64	58	6	30601848
7,00	8	100	16	36	64	58	6	30601849
7,50	8	100	16	36	64	58	6	30601850
8,00	8	100	16	36	64	58	6	30546131
8,50	10	100	20	40	60	54	6	30601851
9,00	10	100	20	40	60	54	6	30601852
9,50	10	120	20	40	80	74	6	30601853
10,00	10	120	20	40	80	74	6	30419221
10,50	12	120	20	45	75	68	6	30601854
11,00	12	120	20	45	75	68	6	30601855
11,50	12	120	20	45	75	68	6	30601856
12,00	12	120	20	45	75	68	6	30466230
13,00	14	130	22	45	85	78	6	30601857
14,00	14	130	22	45	85	78	6	30601858
15,00	16	130	22	48	82	75	6	30601859
16,00	16	150	25	48	102	95	6	30601860
17,00	18	150	25	48	102	95	6	30601861
18,00	18	150	25	48	102	95	6	30601862
19,00	20	150	25	50	100	92	6	30601863
20,00	20	150	25	50	100	92	6	30497749

Dimensions in mm.

Cutting data see page 367 ff.

Intermediate diameters and special tolerances can be ordered by the overview pages for configurable series on page 54.

HNC-AL I 043251

Preferred series for blind bore, internal coolant supply

Design:

Diameter: 4,00-20,00 mm
 Cutting direction: Right-hand cutting
 Cutting material: Solid carbide, BAL coated
 Flute direction: Straight fluted
 Geometry: HPC, EU spacing

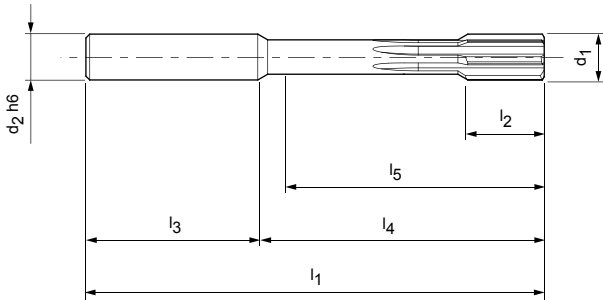

Dimensions							z	Order No.
d_1 H7	d_2 h6	l_1	l_2	l_3	l_4	l_5		
4,00	6	75	12	36	39	34	4	30385429
4,50	6	75	12	36	39	34	4	30385431
5,00	6	75	12	36	39	34	4	30385433
5,50	6	75	12	36	39	34	4	30385434
6,00	6	75	12	36	39	34	4	30385436
6,50	8	100	16	36	64	58	6	30385439
7,00	8	100	16	36	64	58	6	30385440
7,50	8	100	16	36	64	58	6	30385441
8,00	8	100	16	36	64	58	6	30385442
8,50	10	100	20	40	60	54	6	30385443
9,00	10	100	20	40	60	54	6	30385444
9,50	10	120	20	40	80	74	6	30385445
10,00	10	120	20	40	80	74	6	30385446
10,50	12	120	20	45	75	68	6	30385447
11,00	12	120	20	45	75	68	6	30385449
11,50	12	120	20	45	75	68	6	30385451
12,00	12	120	20	45	75	68	6	30385452
13,00	14	130	22	45	85	78	6	30385453
14,00	14	130	22	45	85	78	6	30385454
15,00	16	130	22	48	82	75	6	30385455
16,00	16	150	25	48	102	95	6	30385456
17,00	18	150	25	48	102	95	6	30385458
18,00	18	150	25	48	102	95	6	30385460
19,00	20	150	25	50	100	92	6	30385461
20,00	20	150	25	50	100	92	6	30385464

Dimensions in mm.

Cutting data see page 367 ff.

Intermediate diameters and special tolerances can be ordered by the overview pages for configurable series on page 54.

HNC-HT | 043281

Preferred series for blind bore, internal coolant supply

Design:

Diameter:

Cutting direction:

Cutting material:

Flute direction:

Geometry:

3,97-20,00 mm

Right-hand cutting

Solid carbide,
BHV coated

Straight fluted

HPC, EU spacing

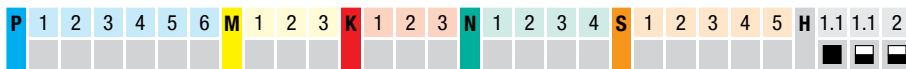
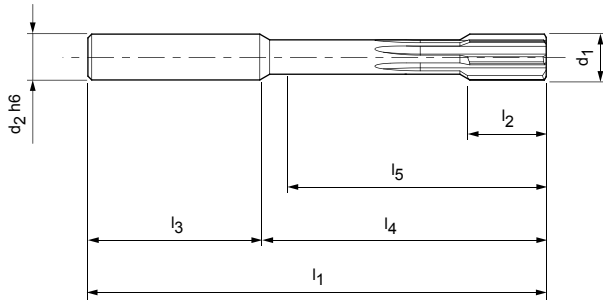

Dimensions								z	Order No.
d_1	Tolerance	$d_2 h6$	l_1	l_2	l_3	l_4	l_5		
3,97	+0,004	6	75	12	36	39	34	4	30301217
3,98	+0,004	6	75	12	36	39	34	4	30301219
3,99	+0,004	6	75	12	36	39	34	4	30301220
4,00	H7	6	75	12	36	39	34	4	30301222
4,01	+0,004	6	75	12	36	39	34	4	30301223
4,02	+0,004	6	75	12	36	39	34	4	30301224
4,03	+0,004	6	75	12	36	39	34	4	30301225
4,50	H7	6	75	12	36	39	34	4	30301226
4,97	+0,004	6	75	12	36	39	34	4	30301227
4,98	+0,004	6	75	12	36	39	34	4	30301228
4,99	+0,004	6	75	12	36	39	34	4	30301229
5,00	H7	6	75	12	36	39	34	4	30301234
5,01	+0,004	6	75	12	36	39	34	4	30301236
5,02	+0,004	6	75	12	36	39	34	4	30301237
5,03	+0,004	6	75	12	36	39	34	4	30301365
5,50	H7	6	75	12	36	39	34	4	30301366
5,97	+0,004	6	75	12	36	39	34	4	30301369
5,98	+0,004	6	75	12	36	39	34	4	30301372
5,99	+0,004	6	75	12	36	39	34	4	30301373
6,00	H7	6	75	12	36	39	34	4	30301374
6,01	+0,004	6	75	12	36	39	34	4	30301375
6,02	+0,004	6	75	12	36	39	34	4	30301376
6,03	+0,004	6	75	12	36	39	34	4	30301377
6,50	H7	8	100	16	36	64	58	6	30301378
7,00	H7	8	100	16	36	64	58	6	30301379
7,50	H7	8	100	16	36	64	58	6	30301380
7,97	+0,004	8	100	16	36	64	58	6	30301381
7,98	+0,004	8	100	16	36	64	58	6	30301382
7,99	+0,004	8	100	16	36	64	58	6	30301383
8,00	H7	8	100	16	36	64	58	6	30228281
8,01	+0,004	8	100	16	36	64	58	6	30301384
8,02	+0,004	8	100	16	36	64	58	6	30301387
8,03	+0,004	8	100	16	36	64	58	6	30301388
8,50	H7	10	100	20	40	60	54	6	30301389
9,00	H7	10	100	20	40	60	54	6	30301390
9,50	H7	10	120	20	40	80	74	6	30301391
9,97	+0,004	10	120	20	40	80	74	6	30301392
9,98	+0,004	10	120	20	40	80	74	6	30301393
9,99	+0,004	10	120	20	40	80	74	6	30301394

HNC-HT | 043281, preferred series for blind bore, internal coolant supply

Dimensions								z	Order No.
d ₁	Tolerance	d ₂ h6	l ₁	l ₂	l ₃	l ₄	l ₅		
10,00	H7	10	120	20	40	80	74	6	30301395
10,01	+0,004	10	120	20	40	80	74	6	30301398
10,02	+0,004	10	120	20	40	80	74	6	30301399
10,03	+0,004	10	120	20	40	80	74	6	30301400
10,50	H7	12	120	20	45	75	68	6	30301401
11,00	H7	12	120	20	45	75	68	6	30301402
11,50	H7	12	120	20	45	75	68	6	30301403
11,97	+0,004	12	120	20	45	75	68	6	30301404
11,98	+0,004	12	120	20	45	75	68	6	30301405
11,99	+0,004	12	120	20	45	75	68	6	30301406
12,00	H7	12	120	20	45	75	68	6	30228282
12,01	+0,004	12	120	20	45	75	68	6	30301452
12,02	+0,004	12	120	20	45	75	68	6	30301453
12,03	+0,004	12	120	20	45	75	68	6	30301455
13,00	H7	14	130	22	45	85	78	6	30301456
14,00	H7	14	130	22	45	85	78	6	30301457
15,00	H7	16	130	22	48	82	75	6	30301465
16,00	H7	16	150	25	48	102	95	6	30228283
17,00	H7	18	150	25	48	102	95	6	30301467
18,00	H7	18	150	25	48	102	95	6	30301470
19,00	H7	20	150	25	50	100	92	6	30301499
20,00	H7	20	150	25	50	100	92	6	30301500

Dimensions in mm.

Cutting data see page 367 ff.

If necessary the reamers diameter must be adjusted to the hardening process or to the components temper. Please ask us for advice!

Intermediate diameters and special tolerances can be ordered by the overview pages for configurable series on page 54.

HNC reamers, overview

Configurable series for blind bore with internal coolant supply

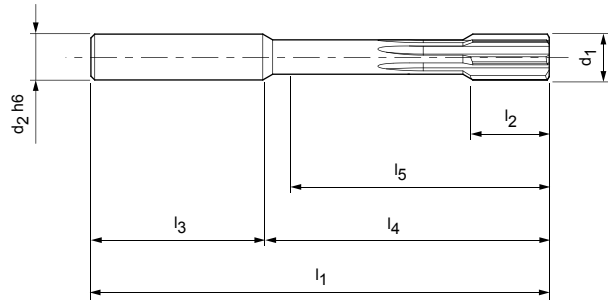

Design:

040261

Diameter:

2,800-20,200 mm

Cutting direction:

Right-hand cutting

Cutting material:

Solid carbide, uncoated

Flute direction:

Straight fluted

Geometry:

HPC, EU spacing

HNC, HNC-AL, HNC-Speed, HNC-VA, HNC-TI, HNC-HT, HNC-Diamond

	P	1	2	3	4	5	6	M	1	2	3	K	1	2	3	N	1	2	3	4	S	1	2	3	4	5	H	1.1	1.2	2
040261																	■	■		□										
043251																	■													
043261		■	■	■		■						■	■	■																
043271				■			■		■	■	■																			
043273																						■	■	■	■	■				
043281																											■	□	□	

	N	1.1	1.2	1.3	1.4	2.1	2.2	2.3	3.1	4.1	4.2	4.3	C	1.1	1.2	1.3	2.1	3.1	4.1	4.2	4.3	4.4	5.1	5.2
043291													■	■	■	■								



Ordering example:

1. BECK product code

0 4 3 2 6 1

BECK product code

2. Diameter

- 1 2 . 2 0 0

Hyphen

Bore diameter

3. Tolerance

H 7

IT or tolerance in μm

043251	043261	043271	043273	043281	043291
3,701-20,200 mm Right-hand cutting Solid carbide, BAL coated Straight fluted HPC, EU spacing	2,800-20,200 mm Right-hand cutting Solid carbide, BSP coated Straight fluted HPC, EU spacing	3,701-20,200 mm Right-hand cutting Solid carbide, BVA coated Straight fluted HPC, EU spacing	3,701-20,200 mm Right-hand cutting Solid carbide, BTI coated Straight fluted HPC, EU spacing	3,701-20,200 mm Right-hand cutting Solid carbide, BHV coated Straight fluted HPC, EU spacing	3,701-20,200 mm Right-hand cutting Solid carbide, Diamond coated Straight fluted HPC, EU spacing

Dimensions							z
d ₁	d ₂	l ₁	l ₂	l ₃	l ₄	l ₅	
2,800-3,030	4	65	12	28	37	33	4
3,031-3,350	4	65	12	28	37	33	4
3,351-3,700	4	65	12	28	37	33	4
3,701-4,200	6	75	12	36	39	34	4
4,201-4,700	6	75	12	36	39	34	4
4,701-5,200	6	75	12	36	39	34	4
5,201-5,700	6	75	12	36	39	34	4
5,701-6,200	6	75	12	36	39	34	4
6,201-6,700	8	100	16	36	64	58	6
6,701-7,200	8	100	16	36	64	58	6
7,201-7,700	8	100	16	36	64	58	6
7,701-8,200	8	100	16	36	64	58	6
8,201-8,700	10	100	20	40	60	54	6
8,701-9,200	10	100	20	40	60	54	6
9,201-9,700	10	120	20	40	80	74	6
9,701-10,200	10	120	20	40	80	74	6
10,201-10,700	12	120	20	45	75	68	6
10,701-11,200	12	120	20	45	75	68	6
11,201-11,700	12	120	20	45	75	68	6
11,701-12,200	12	120	20	45	75	68	6
12,201-13,200	14	130	22	45	85	78	6
13,201-14,200	14	130	22	45	85	78	6
14,201-15,200	16	130	22	48	82	75	6
15,201-16,200	16	150	25	48	102	95	6
16,201-17,200	18	150	25	48	102	95	6
17,201-18,200	18	150	25	48	102	95	6
18,201-19,200	20	150	25	50	100	92	6
19,201-20,200	20	150	25	50	100	92	6

Dimensions in mm.
Cutting data see page 367 ff.

PcBN reamer I 040366

Preferred series for blind bore, internal coolant supply

Design:

Diameter:
Cutting direction:
Cutting material:
Flute direction:
Geometry:

3,00-10,00 mm
Right-hand cutting
PcBN tipped head
Straight fluted
HPC, EU spacing

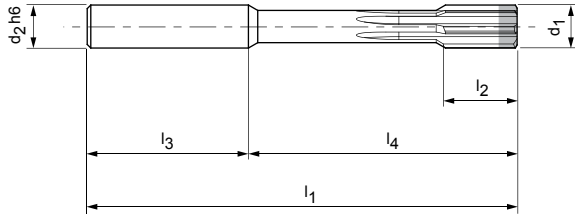

Dimensions						z	Order No.
d ₁ H7	d ₂ h6	l ₁	l ₂	l ₃	l ₄		
3,00	4	65	12	28	37	6	30601813
3,50	4	65	12	28	37	6	30601814
4,00	6	75	12	36	39	6	30601815
4,50	6	75	12	36	39	6	30601816
5,00	6	75	12	36	39	6	30601817
5,50	6	75	12	36	39	6	30601818
6,00	6	75	12	36	39	8	30601819
6,50	8	100	16	36	64	8	30601820
7,00	8	100	16	36	64	8	30601821
7,50	8	100	16	36	64	8	30601822
8,00	8	100	16	36	64	10	30601823
8,50	10	100	16	40	60	10	30601824
9,00	10	100	16	40	60	10	30601825
9,50	10	120	20	40	80	10	30601826
10,00	10	120	20	40	80	10	30601827

Dimensions in mm.

Cutting data see page 367 ff.

PcBN reamers in the ø range 1-3 mm without internal coolant supply on request.

Intermediate diameters and special tolerances can be ordered by the overview pages for configurable series on page 58.

HNC-Short I 043265

Preferred series for blind bore, internal coolant supply

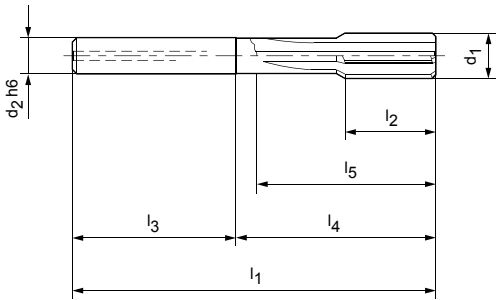

Design:

Diameter: 3,00-20,00 mm
 Cutting direction: Right-hand cutting
 Cutting material: Solid carbide, BSP coated
 Flute direction: Straight fluted
 Geometry: HPC, EU spacing

Special feature:

Suitable for processing on automatic lathes, for short bore-holes



Dimensions							z	Order No.
d_1 H7	d_2 h6	l_1	l_2	l_3	l_4	l_5		
3,00	4	56	12	28	28	24	4	30400036
3,20	4	56	12	28	28	24	4	30400035
3,50	4	56	12	28	28	24	4	30400037
4,00	4	56	12	28	28	24	4	30400038
4,50	6	64	12	36	28	23	4	30400039
5,00	6	64	12	36	28	23	4	30357266
5,50	6	64	12	36	28	24	4	30400040
6,00	6	64	12	36	28	25	4	30356948
6,50	8	75	16	36	39	32	6	30395323
7,00	8	75	16	36	39	34	6	30400043
7,50	8	75	16	36	39	35	6	30400044
8,00	8	75	16	36	39	35	6	30356949
8,50	8	75	20	36	39	35	6	30400046
9,00	8	75	20	36	39	35	6	30400050
9,50	8	75	20	36	39	35	6	30400051
10,00	8	75	20	36	39	35	6	30356951
10,50	10	80	20	40	40	35	6	30400053
11,00	10	80	20	40	40	35	6	30400054
11,50	10	80	20	40	40	35	6	30400055
12,00	12	90	22	45	45	40	6	30356952
13,00	12	90	22	45	45	40	6	30400057
14,00	14	90	22	45	45	40	6	30400058
15,00	14	90	22	45	45	40	6	30400059
16,00	16	100	25	48	52	47	8	30400060
17,00	16	100	25	48	52	47	8	30400061
18,00	16	100	25	48	52	47	8	30384786
19,00	18	100	25	48	52	47	8	30400062
20,00	18	100	25	48	52	47	8	30400063

Dimensions in mm.

Cutting data see page 367 ff.

Intermediate diameters and special tolerances can be ordered by the overview pages for configurable series on page 58.

PcBN reamer / HNC-Short, overview

Configurable series for blind bore

PcBN reamer I 040366

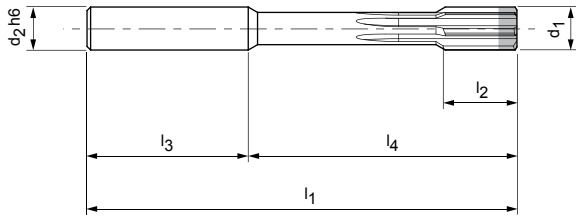

Design:

Diameter: 3,001-10,200 mm
 Cutting direction: Right-hand cutting
 Cutting material: PcBN tipped head
 Flute direction: Straight fluted
 Geometry: HPC, EU spacing

P	1	2	3	4	5	6	M	1	2	3	K	1	2	3	N	1	2	3	4	S	1	2	3	4	5	H	1.1	1.2	



HNC-Short I 043265

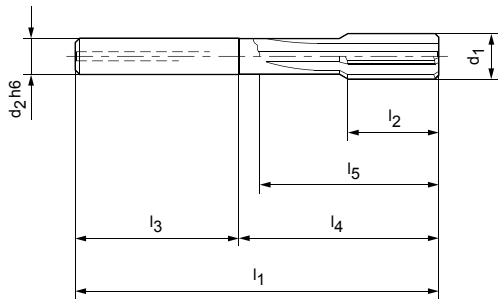

Design:

Diameter: 2,800-20,100 mm
 Cutting direction: Right-hand cutting
 Cutting material: Solid carbide, BSP coated
 Flute direction: Straight fluted
 Geometry: HPC, EU spacing

P	1	2	3	4	5	6	M	1	2	3	K	1	2	3	N	1	2	3	4	S	1	2	3	4	5	H	1	2	



Ordering example:

1. BECK product code

0 4 0 3 6 6

BECK product code

2. Diameter

0 4 . 7 0 0

Bore diameter

3. Tolerance

0 . 0 1 0

IT or tolerance in µm

-

Hyphen

Dimensions						z
d ₁	d ₂	l ₁	l ₂	l ₃	l ₄	
3,001-3,210	4	65	12	28	37	6
3,211-3,710	4	65	12	28	37	6
3,711-4,210	6	75	12	36	39	6
4,211-4,710	6	75	12	36	39	6
4,711-5,210	6	75	12	36	39	6
5,211-5,710	6	75	12	36	39	6
5,711-6,210	6	75	12	36	39	8
6,211-6,710	8	100	16	36	64	8
6,711-7,210	8	100	16	36	64	8
7,211-7,710	8	100	16	36	64	8
7,711-8,210	8	100	16	36	64	10
8,211-8,710	10	100	16	40	60	10
8,711-9,210	10	100	16	40	60	10
9,211-9,710	10	120	20	40	80	10
9,711-10,200	10	120	20	40	80	10

Dimensions							z
d ₁	d ₂	l ₁	l ₂	l ₃	l ₄	l ₅	
2,800-3,100	4	56	12	28	28	24	4
3,101-3,350	4	56	12	28	28	24	4
3,351-3,700	4	56	12	28	28	24	4
3,701-4,050	4	56	12	28	28	24	4
4,051-4,600	6	64	12	36	28	23	4
4,601-5,100	6	64	12	36	28	23	4
5,101-5,600	6	64	12	36	28	24	4
5,601-6,100	6	64	12	36	28	25	4
6,101-6,600	8	75	16	36	39	32	6
6,601-7,100	8	75	16	36	39	34	6
7,101-7,600	8	75	16	36	39	35	6
7,601-8,100	8	75	16	36	39	35	6
8,101-8,600	8	75	20	36	39	35	6
8,601-9,100	8	75	20	36	39	35	6
9,101-9,600	8	75	20	36	39	35	6
9,601-10,100	8	75	20	36	39	35	6
10,101-10,600	10	80	20	40	40	35	6
10,601-11,100	10	80	20	40	40	35	6
11,101-11,600	10	80	20	40	40	35	6
11,601-12,100	12	90	22	45	45	40	6
12,101-13,100	12	90	22	45	45	40	6
13,101-14,100	14	90	22	45	45	40	6
14,101-15,100	14	90	22	45	45	40	6
15,101-16,100	16	100	25	48	52	47	8
16,101-17,100	16	100	25	48	52	47	8
17,101-18,100	16	100	25	48	52	47	8
18,101-19,100	18	100	25	48	52	47	8
19,101-20,100	18	100	25	48	52	47	8

Dimensions in mm.

Cutting data see page 367 ff.

HNC ecoSpeed, HSS I 033260

Preferred series for through bore, internal coolant supply

Design:

Diameter:

6,00-40,00 mm

Cutting direction:

Right-hand cutting

Cutting material:

HSS, coated

Flute direction:

Straight fluted

Geometry:

HPC, EU spacing

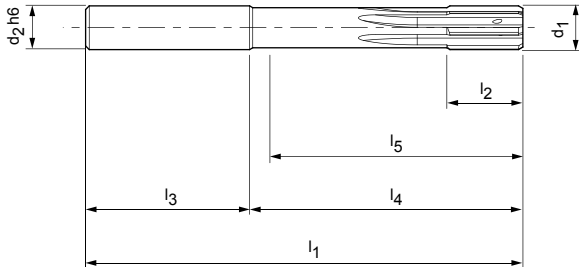

Dimensions							z	Order No.
d_1 H7	d_2h_6	l_1	l_2	l_3	l_4	l_5		
6,00	8	100	16	36	64	58	6	30730611
7,00	8	100	16	36	64	58	6	30730616
8,00	8	100	16	36	64	59	6	30730621
9,00	10	100	20	40	60	54	6	30730626
10,00	10	120	20	40	80	75	6	30730631
11,00	12	120	20	45	75	69	6	30730636
12,00	12	120	20	45	75	70	6	30730641
13,00	14	130	22	45	85	79	6	30730645
14,00	14	130	22	45	85	80	6	30730646
15,00	16	130	22	48	82	76	6	30730647
16,00	16	150	25	48	102	97	6	30730648
17,00	18	150	25	48	102	96	8	30730649
18,00	18	150	25	48	102	97	8	30730650
19,00	20	150	25	50	100	94	8	30730651
20,00	20	150	25	50	100	95	8	30730652
21,00	20	160	25	50	110	105	8	30730653
22,00	20	160	25	50	110	105	8	30730654
23,00	20	180	25	50	130	125	8	30730655
24,00	20	180	25	50	130	125	8	30730656
25,00	20	180	25	50	130	125	8	30730657
26,00	20	180	25	50	130	125	8	30730658
27,00	20	180	25	50	130	125	8	30730659
28,00	25	180	25	56	124	119	8	30730660
29,00	25	180	25	56	124	119	8	30730661
30,00	25	200	25	56	144	139	8	30730662
31,00	25	200	25	56	144	139	8	30730663
32,00	25	200	25	56	144	139	8	30730664
33,00	25	200	25	56	144	139	8	30730665
34,00	25	200	25	56	144	139	8	30730666
35,00	25	200	25	56	144	139	8	30730667
36,00	25	200	25	56	144	139	8	30730668
37,00	25	200	25	56	144	139	8	30730669
38,00	25	200	25	56	144	139	8	30730670
39,00	25	200	25	56	144	139	8	30730671
40,00	25	200	25	56	144	139	8	30730672

Dimensions in mm.

Cutting data see page 367 ff.

Intermediate diameters and special tolerances can be ordered by the overview pages for configurable series on page 62.

HNC ecoSpeed, HSS I 033261

Preferred series for blind bore, internal coolant supply

Design:

Diameter:
Cutting direction:
Cutting material:
Flute direction:
Geometry:

6,00-40,00 mm
Right-hand cutting
HSS, coated
Straight fluted
HPC, EU spacing

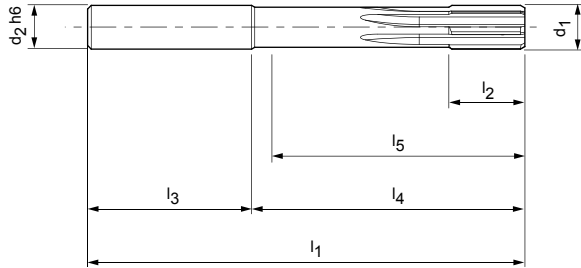

Dimensions							z	Order No.
d_1 H7	d_2 h6	l_1	l_2	l_3	l_4	l_5		
6,00	8	100	16	36	64	39	6	30730726
7,00	8	100	16	36	64	42	6	30730731
8,00	8	100	16	36	64	46	6	30730736
9,00	10	100	20	40	60	40	6	30730741
10,00	10	120	20	40	80	60	6	30730746
11,00	12	120	20	45	75	52	6	30730751
12,00	12	120	20	45	75	54	6	30730756
13,00	14	130	22	45	85	59	6	30730760
14,00	14	130	22	45	85	63	6	30730761
15,00	16	130	22	48	82	58	6	30730762
16,00	16	150	25	48	102	78	6	30730763
17,00	18	150	25	48	102	78	6	30730764
18,00	18	150	25	48	102	80	6	30730765
19,00	20	150	25	50	100	80	6	30730766
20,00	20	150	25	50	100	82	6	30730767
21,00	20	160	25	50	110	93	8	30730768
22,00	20	160	25	50	110	95	8	30730769
23,00	20	180	25	50	130	115	8	30730770
24,00	20	180	25	50	130	115	8	30730771
25,00	20	180	25	50	130	125	8	30730772
26,00	20	180	25	50	130	125	8	30730773
27,00	20	180	25	50	130	125	8	30730774
28,00	25	180	25	56	124	119	8	30730775
29,00	25	180	25	56	124	119	8	30730776
30,00	25	200	25	56	144	139	8	30730777
31,00	25	200	25	56	144	139	8	30730778
32,00	25	200	25	56	144	139	8	30730779
33,00	25	200	25	56	144	139	8	30730780
34,00	25	200	25	56	144	139	8	30730781
35,00	25	200	25	56	144	139	8	30730782
36,00	25	200	25	56	144	139	8	30730783
37,00	25	200	25	56	144	139	8	30730784
38,00	25	200	25	56	144	139	8	30730785
39,00	25	200	25	56	144	139	8	30730786
40,00	25	200	25	56	144	139	8	30730787

Dimensions in mm.

Cutting data see page 367 ff.

Intermediate diameters and special tolerances can be ordered by the overview pages for configurable series on page 62.

HNC ecoSpeed, overview

Configurable series for through bore and blind bore with internal coolant supply

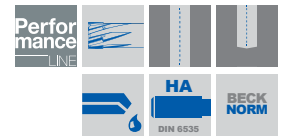
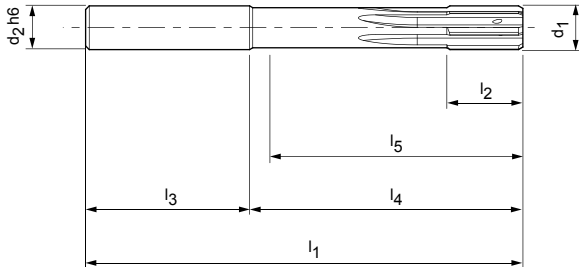

HNC ecoSpeed, HSS I 033260, for through bore

Dimensions							z
d_1	d_{2h6}	l_1	l_2	l_3	l_4	l_5	
6,000-6,700	8	100	16	36	64	58	6
6,701-7,200	8	100	16	36	64	58	6
7,201-7,700	8	100	16	36	64	59	6
7,701-8,200	8	100	16	36	64	59	6
8,201-8,700	10	100	20	40	60	54	6
8,701-9,200	10	100	20	40	60	54	6
9,201-9,700	10	120	20	40	80	75	6
9,701-10,200	10	120	20	40	80	75	6
10,201-10,700	12	120	20	45	75	69	6
10,701-11,200	12	120	20	45	75	69	6
11,201-11,700	12	120	20	45	75	70	6
11,701-12,200	12	120	20	45	75	70	6
12,201-13,200	14	130	22	45	85	79	6
13,201-14,200	14	130	22	45	85	80	6
14,201-15,200	16	130	22	48	82	76	6
15,201-16,200	16	150	25	48	102	97	6
16,201-17,200	18	150	25	48	102	96	8
17,201-18,200	18	150	25	48	102	97	8
18,201-19,200	20	150	25	50	100	94	8
19,201-20,200	20	150	25	50	100	95	8
20,201-21,200	20	160	25	50	110	105	8
21,201-22,200	20	160	25	50	110	105	8
22,201-23,200	20	180	25	50	130	125	8
23,201-24,200	20	180	25	50	130	125	8
24,201-25,200	20	180	25	50	130	125	8
25,201-26,200	20	180	25	50	130	125	8
26,201-27,200	20	180	25	50	130	125	8
27,201-28,200	25	180	25	56	124	119	8
28,201-29,200	25	180	25	56	124	119	8
29,201-30,200	25	200	25	56	144	139	8
30,201-31,200	25	200	25	56	144	139	8
31,201-32,200	25	200	25	56	144	139	8
32,201-33,200	25	200	25	56	144	139	8
33,201-34,200	25	200	25	56	144	139	8
34,201-35,200	25	200	25	56	144	139	8
35,201-36,200	25	200	25	56	144	139	8
36,201-37,200	25	200	25	56	144	139	8
37,201-38,200	25	200	25	56	144	139	8
38,201-39,200	25	200	25	56	144	139	8
39,201-40,200	25	200	25	56	144	139	8

HNC ecoSpeed, HSS I 033261, for blind bore

Dimensions							z
d_1	d_{2h6}	l_1	l_2	l_3	l_4	l_5	
6,000-6,700	8	100	16	36	64	39	6
6,701-7,200	8	100	16	36	64	42	6
7,201-7,700	8	100	16	36	64	44	6
7,701-8,200	8	100	16	36	64	46	6
8,201-8,700	10	100	20	40	60	38	6
8,701-9,200	10	100	20	40	60	40	6
9,201-9,700	10	120	20	40	80	60	6
9,701-10,200	10	120	20	40	80	60	6
10,201-10,700	12	120	20	45	75	51	6
10,701-11,200	12	120	20	45	75	52	6
11,201-11,700	12	120	20	45	75	53	6
11,701-12,200	12	120	20	45	75	54	6
12,201-13,200	14	130	22	45	85	59	6
13,201-14,200	14	130	22	45	85	63	6
14,201-15,200	16	130	22	48	82	58	6
15,201-16,200	16	150	25	48	102	78	6
16,201-17,200	18	150	25	48	102	78	6
17,201-18,200	18	150	25	48	102	80	6
18,201-19,200	20	150	25	50	100	80	6
19,201-20,200	20	150	25	50	100	82	6
20,201-21,200	20	160	25	50	110	93	8
21,201-22,200	20	160	25	50	110	95	8
22,201-23,200	20	180	25	50	130	115	8
23,201-24,200	20	180	25	50	130	115	8
24,201-25,200	20	180	25	50	130	125	8
25,201-26,200	20	180	25	50	130	125	8
26,201-27,200	20	180	25	50	130	125	8
27,201-28,200	25	180	25	56	124	119	8
28,201-29,200	25	180	25	56	124	119	8
29,201-30,200	25	200	25	56	144	139	8
30,201-31,200	25	200	25	56	144	139	8
31,201-32,200	25	200	25	56	144	139	8
32,201-33,200	25	200	25	56	144	139	8
33,201-34,200	25	200	25	56	144	139	8
34,201-35,200	25	200	25	56	144	139	8
35,201-36,200	25	200	25	56	144	139	8
36,201-37,200	25	200	25	56	144	139	8
37,201-38,200	25	200	25	56	144	139	8
38,201-39,200	25	200	25	56	144	139	8
39,201-40,200	25	200	25	56	144	139	8

Alle Dimensions in mm. Cutting data see page 367 ff.

Accessories: WTE hydraulic chuck "Comp-R" DIN 69893-A

With compensation technology

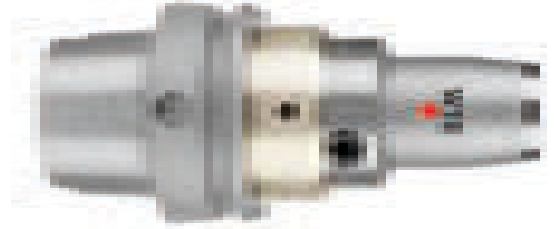
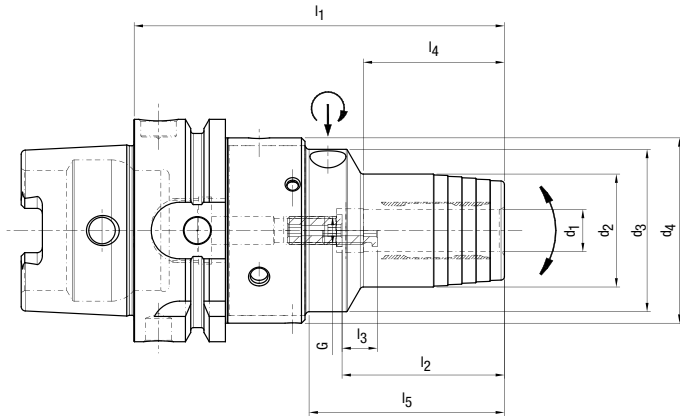

Size HSK-A	Dimensions					G	sw	Weight [kg]	Order designation	Order No.
	d ₁	d ₂	d ₃	d ₄	l ₁					
63	12	32	46	52,5	105	M8x1	3	1.3	16.512.63.12.Z	30614752
63	16	38	46	52,5	110	M8x1	3	1.4	16.512.63.16.Z	30614764
63	20	42	46	52,5	115	M8x1	3	1.5	16.512.63.20.Z	30614765
63	25	57	64	70	145	M16x1	8	2.9	16.512.63.25.Z	30614766
63	32	63	64	70	150	M16x1	8	3.1	16.512.63.32.Z	30614767

Accessories: WTE hydraulic chuck "Comp-R" ISO 7388-1, Form AD/AF

(former DIN 69871-AD/B), with compensation technology

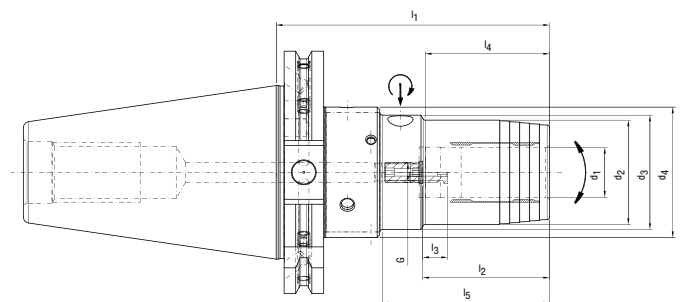

Size SK/ISO	Dimensions					G	sw	Weight [kg]	Order designation	Order No.
	d ₁	d ₂	d ₃	d ₄	l ₁					
50	20	42	46	52,5	110	M8x1	3	3.5	15.512.50.20.Z	30614768
50	25	55	64	70	115	M16x1	8	4.4	15.512.50.25.Z	30614769
50	32	63	64	70	125	M16x1	8	4.7	15.512.50.32.Z	30614770

Dimensions in mm.

Form AD is the basic form for SK 50. Please indicate form AF (previous B) in your order.

MQL capable design for HSK-A 63 available on request.

Custom designs are available on request.





MR REAMERS

Introduction

Product overview	66
------------------	----

Series for through bore

MR 01, fixed design	041610, 041611, 041612, 041613	68
MR 02, expandable design	041710, 041711, 041712, 041713	72
MR 03, finely adjustable design	041810, 041811, 041812, 041813	76
Overview configurable series		80

Series for blind bore

MR 01, fixed design	041650, 041651, 041652, 041653	82
MR 02, expandable design	041750, 041751, 041752, 041753	86
MR 03, finely adjustable design	041850, 041851, 041852, 041853	90
Overview configurable series		94

PRODUCT OVERVIEW

MR reamers – fixed, expandable, finely adjustable

The multi-bladed reamers in the MR series 01, 02 and 03 offer a new, simple, high performance, standardised reaming system. The reamers in the MR series are available as fixed, expandable and finely adjustable versions. Depending on the area of application and material, they can be ordered as left-hand fluted or straight fluted

versions for through bores and blind bores. The three series are compatible with each other. It is therefore possible to change to the optimum system reamer for the specific case if general conditions change in production, for example different quantities or bore tolerances.



MR 01, 02, 03 for through bores

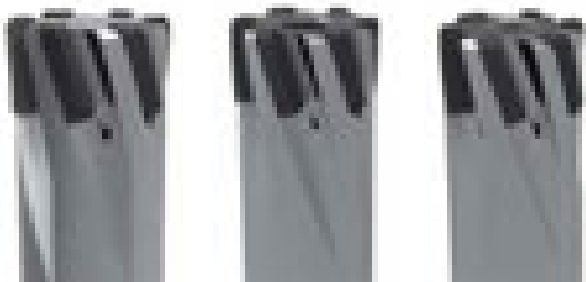

Left-hand fluted design for machining through bores using uncoated or coated carbide or cermet blades.

Ø range: 8.00 - 40.00 mm



MR 01, 02, 03 for blind bores

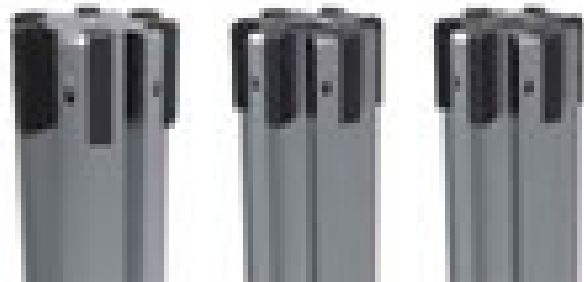

Straight fluted design for machining blind bores using uncoated or coated carbide or cermet blades.

Ø range: 8.00 - 40.00 mm





**System explanation MR 01,
fixed design**

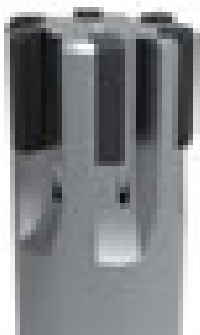

The reamers in the MR 01 series are fixed reamers with brazed blades that cannot be adjusted. They are the simplest of the MR reamers and are the most economical variant to procure.



**System explanation MR 02,
expandable design**

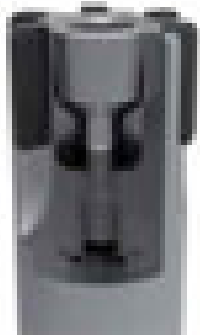

The MR 02 series is used as fixed tools, however this series is optimised for re-grinding. The reamer is expanded in diameter using a one-piece expansion screw. The expansion system is therefore only suitable for compensation prior to re-grinding and not for setting or re-adjusting the diameter. Due to the expansion of the diameter it is possible to re-grind all functional surfaces, both on the lead, and also on the tool diameter.



**System explanation MR 03,
finely adjustable design**

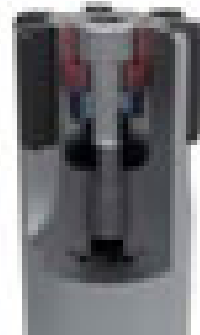

Setting to the μ can be realised with the reamers in the MR 03 series. Due to the high-precision setting system, the blades can be finely adjusted. The special three-piece design with screw, spreader ring and adjusting sleeve makes it possible to compensate for coaxial errors and the radial run-out accuracy of the blades after adjustment is within 3 μ m. Very tight bore tolerances can be achieved reliably using the exactly set MR 03 reamers and cutting materials used optimally.



MR 01 I 041610

Preferred series for through bore, fixed design, with brazed blades

Design:

Diameter:

Cutting direction:

Cutting material:

Flute direction:

Geometry:

8,00-40,00 mm

Right-hand cutting

Carbide, uncoated

Left-hand fluted

HPC geometry

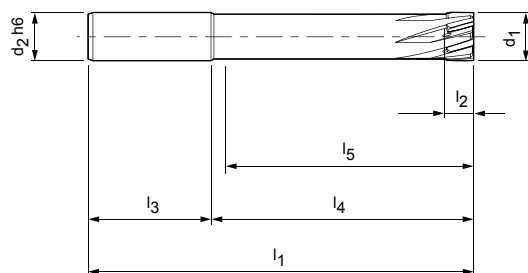

Dimensions							z	Order No.
$d_1 H7$	$d_2 h6$	l_1	l_2	l_3	l_4	l_5		
8,00	12	120	8	45	75	70	4	30480651
8,50	12	120	8	45	75	70	4	30480652
9,00	12	120	8	45	75	70	4	30480653
9,50	12	120	8	45	75	70	4	30480654
10,00	12	120	8	45	75	70	6	30480655
10,50	12	120	8	45	75	70	6	30480656
11,00	12	120	8	45	75	70	6	30480657
11,50	12	120	8	45	75	70	6	30480658
12,00	16	140	8	48	92	87	6	30480659
12,50	16	140	8	48	92	87	6	30480660
13,00	16	140	8	48	92	87	6	30480661
14,00	16	140	8	48	92	87	6	30479663
15,00	16	140	8	48	92	87	6	30480662
16,00	16	140	8	48	92	87	6	30480663
17,00	16	140	8	48	92	87	6	30480664
18,00	20	160	12	50	110	105	6	30480665
19,00	20	160	12	50	110	105	6	30480666
20,00	20	160	12	50	110	105	6	30480667
21,00	20	160	12	50	110	105	6	30480668
22,00	20	160	12	50	110	105	6	30400729
23,00	20	180	12	50	130	125	6	30480669
24,00	20	180	12	50	130	125	6	30480670
25,00	20	180	12	50	130	125	6	30480671
26,00	20	180	12	50	130	125	6	30480672
27,00	20	180	12	50	130	125	6	30400730
28,00	25	200	12	56	144	139	6	30480673
29,00	25	200	12	56	144	139	6	30480674
30,00	25	200	12	56	144	139	8	30480675
31,00	25	200	12	56	144	139	8	30480676
32,00	25	200	12	56	144	139	8	30480677
33,00	25	200	12	56	144	139	8	30480678
34,00	25	200	12	56	144	139	8	30480679
35,00	25	200	12	56	144	139	8	30480680
36,00	25	200	12	56	144	139	8	30480681
37,00	25	200	12	56	144	139	8	30480682
38,00	25	200	12	56	144	139	8	30480683
39,00	25	200	12	56	144	139	8	30480684
40,00	25	200	12	56	144	139	8	30480685

Dimensions in mm. Cutting data see page 367 ff.

Intermediate diameters and special tolerances can be ordered by the overview pages for configurable series on page 80.

MR 01 | 041611

Preferred series for through bore, fixed design, with brazed blades

Design:

Diameter:
Cutting direction:
Cutting material:
Flute direction:
Geometry:

8,00-40,00 mm
Right-hand cutting
Carbide, BSP coated
Left-hand fluted
HPC geometry

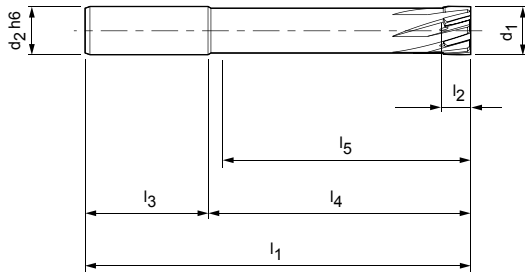

Dimensions							z	Order No.
$d_1 H7$	$d_2 h6$	l_1	l_2	l_3	l_4	l_5		
8,00	12	120	8	45	75	70	4	30480686
8,50	12	120	8	45	75	70	4	30480687
9,00	12	120	8	45	75	70	4	30480688
9,50	12	120	8	45	75	70	4	30480689
10,00	12	120	8	45	75	70	6	30480690
10,50	12	120	8	45	75	70	6	30480691
11,00	12	120	8	45	75	70	6	30480692
11,50	12	120	8	45	75	70	6	30480693
12,00	16	140	8	48	92	87	6	30480694
12,50	16	140	8	48	92	87	6	30480695
13,00	16	140	8	48	92	87	6	30480696
14,00	16	140	8	48	92	87	6	30480697
15,00	16	140	8	48	92	87	6	30480698
16,00	16	140	8	48	92	87	6	30480699
17,00	16	140	8	48	92	87	6	30480700
18,00	20	160	12	50	110	105	6	30480701
19,00	20	160	12	50	110	105	6	30480702
20,00	20	160	12	50	110	105	6	30480703
21,00	20	160	12	50	110	105	6	30480704
22,00	20	160	12	50	110	105	6	30480705
23,00	20	180	12	50	130	125	6	30480706
24,00	20	180	12	50	130	125	6	30480707
25,00	20	180	12	50	130	125	6	30480708
26,00	20	180	12	50	130	125	6	30480709
27,00	20	180	12	50	130	125	6	30480710
28,00	25	200	12	56	144	139	6	30480711
29,00	25	200	12	56	144	139	6	30480712
30,00	25	200	12	56	144	139	8	30480713
31,00	25	200	12	56	144	139	8	30480714
32,00	25	200	12	56	144	139	8	30477650
33,00	25	200	12	56	144	139	8	30480715
34,00	25	200	12	56	144	139	8	30480716
35,00	25	200	12	56	144	139	8	30480717
36,00	25	200	12	56	144	139	8	30480718
37,00	25	200	12	56	144	139	8	30480719
38,00	25	200	12	56	144	139	8	30480720
39,00	25	200	12	56	144	139	8	30480721
40,00	25	200	12	56	144	139	8	30480722

Dimensions in mm. Cutting data see page 367 ff.

Intermediate diameters and special tolerances can be ordered by the overview pages for configurable series on page 80.

MR 01 I 041612

Preferred series for through bore, fixed design, with brazed blades

Design:

Diameter:

Cutting direction:

Cutting material:

Flute direction:

Geometry:

8,00-40,00 mm

Right-hand cutting

Cermet, uncoated

Left-hand fluted

HPC geometry

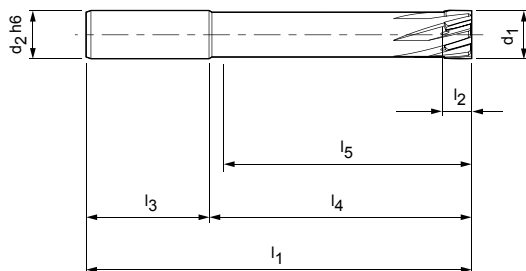

Dimensions							z	Order No.
d_1 H7	d_2 h6	l_1	l_2	l_3	l_4	l_5		
8,00	12	120	8	45	75	70	4	30480723
8,50	12	120	8	45	75	70	4	30480724
9,00	12	120	8	45	75	70	4	30480725
9,50	12	120	8	45	75	70	4	30480726
10,00	12	120	8	45	75	70	6	30480727
10,50	12	120	8	45	75	70	6	30480728
11,00	12	120	8	45	75	70	6	30480729
11,50	12	120	8	45	75	70	6	30480730
12,00	16	140	8	48	92	87	6	30480731
12,50	16	140	8	48	92	87	6	30480732
13,00	16	140	8	48	92	87	6	30480733
14,00	16	140	8	48	92	87	6	30480734
15,00	16	140	8	48	92	87	6	30480735
16,00	16	140	8	48	92	87	6	30480736
17,00	16	140	8	48	92	87	6	30480737
18,00	20	160	12	50	110	105	6	30480738
19,00	20	160	12	50	110	105	6	30480739
20,00	20	160	12	50	110	105	6	30480740
21,00	20	160	12	50	110	105	6	30480741
22,00	20	160	12	50	110	105	6	30480742
23,00	20	180	12	50	130	125	6	30480743
24,00	20	180	12	50	130	125	6	30480744
25,00	20	180	12	50	130	125	6	30480745
26,00	20	180	12	50	130	125	6	30480746
27,00	20	180	12	50	130	125	6	30480747
28,00	25	200	12	56	144	139	6	30480748
29,00	25	200	12	56	144	139	6	30480749
30,00	25	200	12	56	144	139	8	30480750
31,00	25	200	12	56	144	139	8	30480751
32,00	25	200	12	56	144	139	8	30480752
33,00	25	200	12	56	144	139	8	30480753
34,00	25	200	12	56	144	139	8	30480754
35,00	25	200	12	56	144	139	8	30480755
36,00	25	200	12	56	144	139	8	30480756
37,00	25	200	12	56	144	139	8	30480757
38,00	25	200	12	56	144	139	8	30480758
39,00	25	200	12	56	144	139	8	30480759
40,00	25	200	12	56	144	139	8	30480760

Dimensions in mm. Cutting data see page 367 ff.

Intermediate diameters and special tolerances can be ordered by the overview pages for configurable series on page 80.

MR 01 I 041613

Preferred series for through bore, fixed design, with brazed blades

Design:

Diameter:
Cutting direction:
Cutting material:
Flute direction:
Geometry:

8,00-40,00 mm
Right-hand cutting
Cermet, coated
Left-hand fluted
HPC geometry

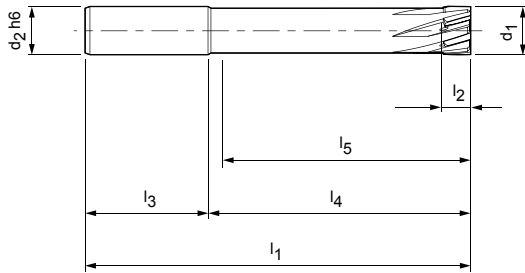

Dimensions							z	Order No.
d_1 H7	d_2 h6	l_1	l_2	l_3	l_4	l_5		
8,00	12	120	8	45	75	70	4	30480761
8,50	12	120	8	45	75	70	4	30480762
9,00	12	120	8	45	75	70	4	30480763
9,50	12	120	8	45	75	70	4	30480764
10,00	12	120	8	45	75	70	6	30480765
10,50	12	120	8	45	75	70	6	30480766
11,00	12	120	8	45	75	70	6	30480767
11,50	12	120	8	45	75	70	6	30480768
12,00	16	140	8	48	92	87	6	30480769
12,50	16	140	8	48	92	87	6	30480770
13,00	16	140	8	48	92	87	6	30480771
14,00	16	140	8	48	92	87	6	30480772
15,00	16	140	8	48	92	87	6	30480773
16,00	16	140	8	48	92	87	6	30480774
17,00	16	140	8	48	92	87	6	30480775
18,00	20	160	12	50	110	105	6	30480776
19,00	20	160	12	50	110	105	6	30480777
20,00	20	160	12	50	110	105	6	30480778
21,00	20	160	12	50	110	105	6	30480779
22,00	20	160	12	50	110	105	6	30480780
23,00	20	180	12	50	130	125	6	30480781
24,00	20	180	12	50	130	125	6	30480782
25,00	20	180	12	50	130	125	6	30480783
26,00	20	180	12	50	130	125	6	30480784
27,00	20	180	12	50	130	125	6	30480785
28,00	25	200	12	56	144	139	6	30480786
29,00	25	200	12	56	144	139	6	30480787
30,00	25	200	12	56	144	139	8	30480788
31,00	25	200	12	56	144	139	8	30480789
32,00	25	200	12	56	144	139	8	30480790
33,00	25	200	12	56	144	139	8	30480791
34,00	25	200	12	56	144	139	8	30480792
35,00	25	200	12	56	144	139	8	30480793
36,00	25	200	12	56	144	139	8	30480794
37,00	25	200	12	56	144	139	8	30480795
38,00	25	200	12	56	144	139	8	30480796
39,00	25	200	12	56	144	139	8	30480797
40,00	25	200	12	56	144	139	8	30480798

Dimensions in mm. Cutting data see page 367 ff.

Intermediate diameters and special tolerances can be ordered by the overview pages for configurable series on page 80.

MR 02 I 041710

Preferred series for through bore, expandable design, with brazed blades

Design:

Diameter:

Cutting direction:

Flute direction:

Geometry:

8,00-40,00 mm

Right-hand cutting

Carbide, uncoated

Left-hand fluted

HPC geometry

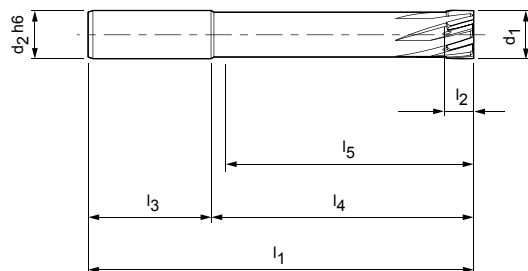

Dimensions							z	Order No.
$d_1 H7$	$d_2 h6$	l_1	l_2	l_3	l_4	l_5		
8,00	12	120	8	45	75	64	4	30481120
8,50	12	120	8	45	75	64	4	30481121
9,00	12	120	8	45	75	64	4	30481122
9,50	12	120	8	45	75	65	4	30481123
10,00	12	120	8	45	75	65	6	30481124
10,50	12	120	8	45	75	65	6	30481125
11,00	12	120	8	45	75	65	6	30481126
11,50	12	120	8	45	75	65	6	30481127
12,00	16	140	8	48	92	65	6	30481128
12,50	16	140	8	48	92	80	6	30481129
13,00	16	140	8	48	92	80	6	30481130
14,00	16	140	8	48	92	80	6	30481131
15,00	16	140	8	48	92	80	6	30481132
16,00	16	140	8	48	92	80	6	30481133
17,00	16	140	8	48	92	80	6	30481134
18,00	20	160	12	50	110	98	6	30481135
19,00	20	160	12	50	110	99	6	30481136
20,00	20	160	12	50	110	100	6	30481137
21,00	20	160	12	50	110	100	6	30481138
22,00	20	160	12	50	110	100	6	30481139
23,00	20	180	12	50	130	120	6	30481140
24,00	20	180	12	50	130	120	6	30481141
25,00	20	180	12	50	130	120	6	30481142
26,00	20	180	12	50	130	120	6	30481143
27,00	20	180	12	50	130	120	6	30481144
28,00	25	200	12	56	144	130	6	30481145
29,00	25	200	12	56	144	130	6	30481146
30,00	25	200	12	56	144	130	8	30481147
31,00	25	200	12	56	144	130	8	30481148
32,00	25	200	12	56	144	130	8	30481149
33,00	25	200	12	56	144	130	8	30481150
34,00	25	200	12	56	144	130	8	30481151
35,00	25	200	12	56	144	130	8	30481152
36,00	25	200	12	56	144	130	8	30481153
37,00	25	200	12	56	144	130	8	30481154
38,00	25	200	12	56	144	130	8	30481155
39,00	25	200	12	56	144	130	8	30481156
40,00	25	200	12	56	144	130	8	30481157

Dimensions in mm. Cutting data see page 367 ff.

Intermediate diameters and special tolerances can be ordered by the overview pages for configurable series on page 80.

MR 02 I 041711

Preferred series for through bore, expandable design, with brazed blades

Design:

Diameter:
Cutting direction:
Cutting material:
Flute direction:
Geometry:

8,00-40,00 mm
Right-hand cutting
Carbide, BSP coated
Left-hand fluted
HPC geometry

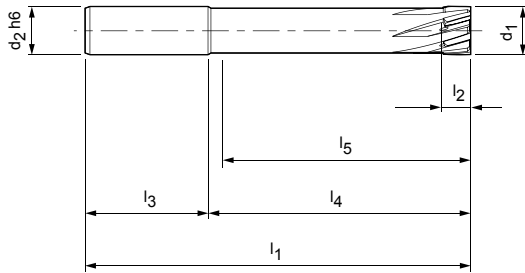

Dimensions							z	Order No.
$d_1 H7$	$d_2 h6$	l_1	l_2	l_3	l_4	l_5		
8,00	12	120	8	45	75	64	4	30481158
8,50	12	120	8	45	75	64	4	30481159
9,00	12	120	8	45	75	64	4	30481160
9,50	12	120	8	45	75	65	4	30481161
10,00	12	120	8	45	75	65	6	30481162
10,50	12	120	8	45	75	65	6	30481163
11,00	12	120	8	45	75	65	6	30481164
11,50	12	120	8	45	75	65	6	30481165
12,00	16	140	8	48	92	65	6	30481166
12,50	16	140	8	48	92	80	6	30481167
13,00	16	140	8	48	92	80	6	30481168
14,00	16	140	8	48	92	80	6	30481169
15,00	16	140	8	48	92	80	6	30481170
16,00	16	140	8	48	92	80	6	30481171
17,00	16	140	8	48	92	80	6	30481172
18,00	20	160	12	50	110	98	6	30481173
19,00	20	160	12	50	110	99	6	30481174
20,00	20	160	12	50	110	100	6	30481175
21,00	20	160	12	50	110	100	6	30481176
22,00	20	160	12	50	110	100	6	30481177
23,00	20	180	12	50	130	120	6	30481178
24,00	20	180	12	50	130	120	6	30481179
25,00	20	180	12	50	130	120	6	30481180
26,00	20	180	12	50	130	120	6	30481181
27,00	20	180	12	50	130	120	6	30481182
28,00	25	200	12	56	144	130	6	30481183
29,00	25	200	12	56	144	130	6	30481184
30,00	25	200	12	56	144	130	8	30481185
31,00	25	200	12	56	144	130	8	30481186
32,00	25	200	12	56	144	130	8	30481187
33,00	25	200	12	56	144	130	8	30481188
34,00	25	200	12	56	144	130	8	30481189
35,00	25	200	12	56	144	130	8	30481190
36,00	25	200	12	56	144	130	8	30481191
37,00	25	200	12	56	144	130	8	30481192
38,00	25	200	12	56	144	130	8	30481193
39,00	25	200	12	56	144	130	8	30481194
40,00	25	200	12	56	144	130	8	30481195

Dimensions in mm. Cutting data see page 367 ff.

Intermediate diameters and special tolerances can be ordered by the overview pages for configurable series on page 80.

MR 02 I 041712

Preferred series for through bore, expandable design, with brazed blades

Design:

Diameter:

Cutting direction:

Flute direction:

Geometry:

8,00-40,00 mm

Right-hand cutting

Cermet, uncoated

Left-hand fluted

HPC geometry

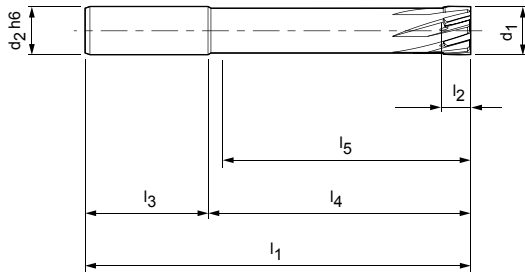

Dimensions							z	Order No.
$d_1 H7$	$d_2 h6$	l_1	l_2	l_3	l_4	l_5		
8,00	12	120	8	45	75	64	4	30481196
8,50	12	120	8	45	75	64	4	30481197
9,00	12	120	8	45	75	64	4	30481198
9,50	12	120	8	45	75	65	4	30481199
10,00	12	120	8	45	75	65	6	30481200
10,50	12	120	8	45	75	65	6	30481201
11,00	12	120	8	45	75	65	6	30481202
11,50	12	120	8	45	75	65	6	30481203
12,00	16	140	8	48	92	65	6	30481204
12,50	16	140	8	48	92	80	6	30481205
13,00	16	140	8	48	92	80	6	30481206
14,00	16	140	8	48	92	80	6	30481207
15,00	16	140	8	48	92	80	6	30481208
16,00	16	140	8	48	92	80	6	30481209
17,00	16	140	8	48	92	80	6	30481210
18,00	20	160	12	50	110	98	6	30481211
19,00	20	160	12	50	110	99	6	30481212
20,00	20	160	12	50	110	100	6	30481213
21,00	20	160	12	50	110	100	6	30481214
22,00	20	160	12	50	110	100	6	30481215
23,00	20	180	12	50	130	120	6	30481216
24,00	20	180	12	50	130	120	6	30481217
25,00	20	180	12	50	130	120	6	30481218
26,00	20	180	12	50	130	120	6	30481219
27,00	20	180	12	50	130	120	6	30481220
28,00	25	200	12	56	144	130	6	30481221
29,00	25	200	12	56	144	130	6	30481222
30,00	25	200	12	56	144	130	8	30481223
31,00	25	200	12	56	144	130	8	30481224
32,00	25	200	12	56	144	130	8	30481225
33,00	25	200	12	56	144	130	8	30481226
34,00	25	200	12	56	144	130	8	30481227
35,00	25	200	12	56	144	130	8	30481228
36,00	25	200	12	56	144	130	8	30481229
37,00	25	200	12	56	144	130	8	30481230
38,00	25	200	12	56	144	130	8	30481231
39,00	25	200	12	56	144	130	8	30481232
40,00	25	200	12	56	144	130	8	30481233

Dimensions in mm. Cutting data see page 367 ff.

Intermediate diameters and special tolerances can be ordered by the overview pages for configurable series on page 80.

MR 02 I 041713

Preferred series for through bore, expandable design, with brazed blades

Design:

Diameter:
Cutting direction:
Cutting material:
Flute direction:
Geometry:

8,00-40,00 mm
Right-hand cutting
Cermet, coated
Left-hand fluted
HPC geometry

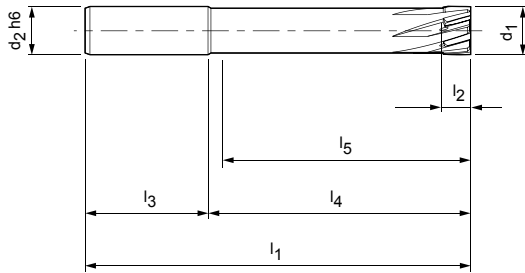

Dimensions							z	Order No.
$d_1 H7$	$d_2 h6$	l_1	l_2	l_3	l_4	l_5		
8,00	12	120	8	45	75	64	4	30481234
8,50	12	120	8	45	75	64	4	30481235
9,00	12	120	8	45	75	64	4	30481236
9,50	12	120	8	45	75	65	4	30481237
10,00	12	120	8	45	75	65	6	30481238
10,50	12	120	8	45	75	65	6	30481239
11,00	12	120	8	45	75	65	6	30481240
11,50	12	120	8	45	75	65	6	30481241
12,00	16	140	8	48	92	65	6	30481242
12,50	16	140	8	48	92	80	6	30481243
13,00	16	140	8	48	92	80	6	30481244
14,00	16	140	8	48	92	80	6	30481245
15,00	16	140	8	48	92	80	6	30481246
16,00	16	140	8	48	92	80	6	30481247
17,00	16	140	8	48	92	80	6	30481248
18,00	20	160	12	50	110	98	6	30481249
19,00	20	160	12	50	110	99	6	30481250
20,00	20	160	12	50	110	100	6	30488593
21,00	20	160	12	50	110	100	6	30481252
22,00	20	160	12	50	110	100	6	30481253
23,00	20	180	12	50	130	120	6	30481254
24,00	20	180	12	50	130	120	6	30481255
25,00	20	180	12	50	130	120	6	30481256
26,00	20	180	12	50	130	120	6	30481257
27,00	20	180	12	50	130	120	6	30481258
28,00	25	200	12	56	144	130	6	30481259
29,00	25	200	12	56	144	130	6	30481260
30,00	25	200	12	56	144	130	8	30481261
31,00	25	200	12	56	144	130	8	30481262
32,00	25	200	12	56	144	130	8	30481263
33,00	25	200	12	56	144	130	8	30481264
34,00	25	200	12	56	144	130	8	30481265
35,00	25	200	12	56	144	130	8	30481266
36,00	25	200	12	56	144	130	8	30481267
37,00	25	200	12	56	144	130	8	30481268
38,00	25	200	12	56	144	130	8	30481269
39,00	25	200	12	56	144	130	8	30481270
40,00	25	200	12	56	144	130	8	30481271

Dimensions in mm. Cutting data see page 367 ff.

Intermediate diameters and special tolerances can be ordered by the overview pages for configurable series on page 80.

MR 03 I 041810

Preferred series for through bore, finely adjustable design, with brazed blades

Design:

Diameter:
Cutting direction:
Cutting material:
Flute direction:
Geometry:

8,00-40,00 mm
Right-hand cutting
Carbide, uncoated
Left-hand fluted
HPC geometry

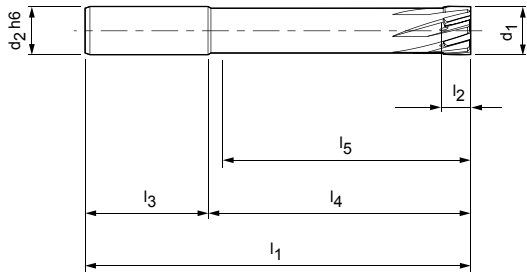

Dimensions							z	Order No.
$d_1 H7$	$d_2 h6$	l_1	l_2	l_3	l_4	l_5		
8,00	12	120	8	45	75	64	4	30481579
8,50	12	120	8	45	75	64	4	30481580
9,00	12	120	8	45	75	64	4	30481581
9,50	12	120	8	45	75	65	4	30481582
10,00	12	120	8	45	75	65	6	30481583
10,50	12	120	8	45	75	65	6	30481584
11,00	12	120	8	45	75	65	6	30481585
11,50	12	120	8	45	75	65	6	30481586
12,00	16	140	8	48	92	65	6	30481587
12,50	16	140	8	48	92	80	6	30481588
13,00	16	140	8	48	92	80	6	30481589
14,00	16	140	8	48	92	80	6	30481590
15,00	16	140	8	48	92	80	6	30481591
16,00	16	140	8	48	92	80	6	30481592
17,00	16	140	8	48	92	80	6	30481593
18,00	20	160	12	50	110	98	6	30481594
19,00	20	160	12	50	110	99	6	30481595
20,00	20	160	12	50	110	100	6	30481596
21,00	20	160	12	50	110	100	6	30481597
22,00	20	160	12	50	110	100	6	30481598
23,00	20	180	12	50	130	120	6	30481600
24,00	20	180	12	50	130	120	6	30481601
25,00	20	180	12	50	130	120	6	30481602
26,00	20	180	12	50	130	120	6	30481603
27,00	20	180	12	50	130	120	6	30481604
28,00	25	200	12	56	144	130	6	30481605
29,00	25	200	12	56	144	130	6	30481606
30,00	25	200	12	56	144	130	8	30481607
31,00	25	200	12	56	144	130	8	30481608
32,00	25	200	12	56	144	130	8	30481609
33,00	25	200	12	56	144	130	8	30481610
34,00	25	200	12	56	144	130	8	30481611
35,00	25	200	12	56	144	130	8	30481612
36,00	25	200	12	56	144	130	8	30481613
37,00	25	200	12	56	144	130	8	30481614
38,00	25	200	12	56	144	130	8	30481615
39,00	25	200	12	56	144	130	8	30481616
40,00	25	200	12	56	144	130	8	30481617

Dimensions in mm. Cutting data see page 367 ff.

Intermediate diameters and special tolerances can be ordered by the overview pages for configurable series on page 80.

MR 03 | 041811

Preferred series for through bore, finely adjustable design, with brazed blades

Design:

Diameter:
Cutting direction:
Cutting material:
Flute direction:
Geometry:

8,00-40,00 mm
Right-hand cutting
Carbide, BSP coated
Left-hand fluted
HPC geometry

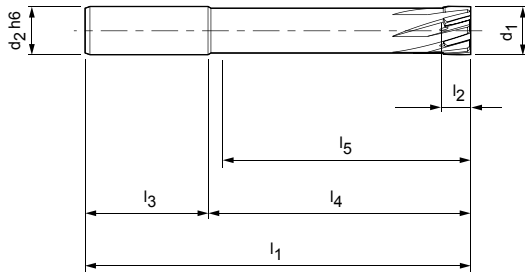

Dimensions							z	Order No.
$d_1 H7$	$d_2 h6$	l_1	l_2	l_3	l_4	l_5		
8,00	12	120	8	45	75	64	4	30481618
8,50	12	120	8	45	75	64	4	30481619
9,00	12	120	8	45	75	64	4	30481620
9,50	12	120	8	45	75	65	4	30481621
10,00	12	120	8	45	75	65	6	30481622
10,50	12	120	8	45	75	65	6	30481623
11,00	12	120	8	45	75	65	6	30481624
11,50	12	120	8	45	75	65	6	30481625
12,00	16	140	8	48	92	65	6	30481626
12,50	16	140	8	48	92	80	6	30481627
13,00	16	140	8	48	92	80	6	30481628
14,00	16	140	8	48	92	80	6	30481629
15,00	16	140	8	48	92	80	6	30481630
16,00	16	140	8	48	92	80	6	30481631
17,00	16	140	8	48	92	80	6	30481632
18,00	20	160	12	50	110	98	6	30481633
19,00	20	160	12	50	110	99	6	30481634
20,00	20	160	12	50	110	100	6	30481635
21,00	20	160	12	50	110	100	6	30481636
22,00	20	160	12	50	110	100	6	30481637
23,00	20	180	12	50	130	120	6	30481638
24,00	20	180	12	50	130	120	6	30481639
25,00	20	180	12	50	130	120	6	30481640
26,00	20	180	12	50	130	120	6	30481641
27,00	20	180	12	50	130	120	6	30481642
28,00	25	200	12	56	144	130	6	30481643
29,00	25	200	12	56	144	130	6	30481644
30,00	25	200	12	56	144	130	8	30481645
31,00	25	200	12	56	144	130	8	30481646
32,00	25	200	12	56	144	130	8	30481647
33,00	25	200	12	56	144	130	8	30481648
34,00	25	200	12	56	144	130	8	30481649
35,00	25	200	12	56	144	130	8	30481650
36,00	25	200	12	56	144	130	8	30481651
37,00	25	200	12	56	144	130	8	30481652
38,00	25	200	12	56	144	130	8	30481653
39,00	25	200	12	56	144	130	8	30481654
40,00	25	200	12	56	144	130	8	30481655

Dimensions in mm. Cutting data see page 367 ff.

Intermediate diameters and special tolerances can be ordered by the overview pages for configurable series on page 80.

MR 03 I 041812

Preferred series for through bore, finely adjustable design, with brazed blades

Design:

Diameter:
Cutting direction:
Cutting material:
Flute direction:
Geometry:

8,00-40,00 mm
Right-hand cutting
Cermet, uncoated
Left-hand fluted
HPC geometry

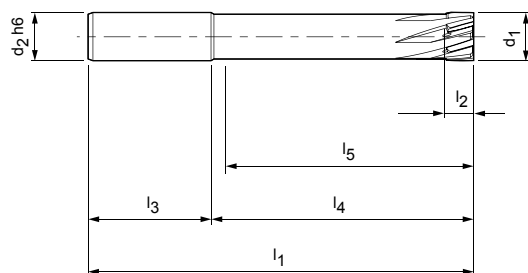

Dimensions							z	Order No.
$d_1 H7$	$d_2 h6$	l_1	l_2	l_3	l_4	l_5		
8,00	12	120	8	45	75	64	4	30481656
8,50	12	120	8	45	75	64	4	30481657
9,00	12	120	8	45	75	64	4	30481658
9,50	12	120	8	45	75	65	4	30481659
10,00	12	120	8	45	75	65	6	30481660
10,50	12	120	8	45	75	65	6	30481661
11,00	12	120	8	45	75	65	6	30481662
11,50	12	120	8	45	75	65	6	30481663
12,00	16	140	8	48	92	65	6	30481664
12,50	16	140	8	48	92	80	6	30481665
13,00	16	140	8	48	92	80	6	30481666
14,00	16	140	8	48	92	80	6	30481667
15,00	16	140	8	48	92	80	6	30481668
16,00	16	140	8	48	92	80	6	30481669
17,00	16	140	8	48	92	80	6	30481670
18,00	20	160	12	50	110	98	6	30481671
19,00	20	160	12	50	110	99	6	30481672
20,00	20	160	12	50	110	100	6	30481673
21,00	20	160	12	50	110	100	6	30481674
22,00	20	160	12	50	110	100	6	30481675
23,00	20	180	12	50	130	120	6	30481676
24,00	20	180	12	50	130	120	6	30481677
25,00	20	180	12	50	130	120	6	30481678
26,00	20	180	12	50	130	120	6	30481679
27,00	20	180	12	50	130	120	6	30481680
28,00	25	200	12	56	144	130	6	30481681
29,00	25	200	12	56	144	130	6	30481682
30,00	25	200	12	56	144	130	8	30481683
31,00	25	200	12	56	144	130	8	30481684
32,00	25	200	12	56	144	130	8	30481685
33,00	25	200	12	56	144	130	8	30481686
34,00	25	200	12	56	144	130	8	30481687
35,00	25	200	12	56	144	130	8	30481688
36,00	25	200	12	56	144	130	8	30481689
37,00	25	200	12	56	144	130	8	30481690
38,00	25	200	12	56	144	130	8	30481691
39,00	25	200	12	56	144	130	8	30481692
40,00	25	200	12	56	144	130	8	30481693

Dimensions in mm. Cutting data see page 367 ff.

Intermediate diameters and special tolerances can be ordered by the overview pages for configurable series on page 80.

MR 03 I 041813

Preferred series for through bore, finely adjustable design, with brazed blades

Design:

Diameter:
Cutting direction:
Cutting material:
Flute direction:
Geometry:

8,00-40,00 mm
Right-hand cutting
Cermet, coated
Left-hand fluted
HPC geometry

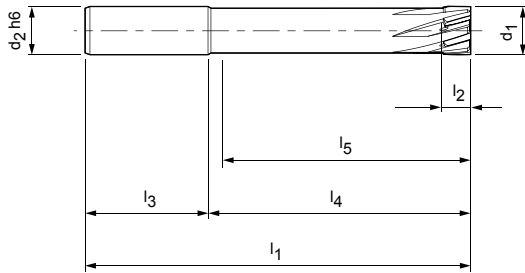

Dimensions							z	Order No.
$d_1 H7$	$d_2 h6$	l_1	l_2	l_3	l_4	l_5		
8,00	12	120	8	45	75	64	4	30481694
8,50	12	120	8	45	75	64	4	30481695
9,00	12	120	8	45	75	64	4	30481696
9,50	12	120	8	45	75	65	4	30481697
10,00	12	120	8	45	75	65	6	30481698
10,50	12	120	8	45	75	65	6	30481699
11,00	12	120	8	45	75	65	6	30481700
11,50	12	120	8	45	75	65	6	30481701
12,00	16	140	8	48	92	65	6	30481702
12,50	16	140	8	48	92	80	6	30481703
13,00	16	140	8	48	92	80	6	30481704
14,00	16	140	8	48	92	80	6	30481705
15,00	16	140	8	48	92	80	6	30481706
16,00	16	140	8	48	92	80	6	30481707
17,00	16	140	8	48	92	80	6	30481708
18,00	20	160	12	50	110	98	6	30481709
19,00	20	160	12	50	110	99	6	30481710
20,00	20	160	12	50	110	100	6	30481711
21,00	20	160	12	50	110	100	6	30481712
22,00	20	160	12	50	110	100	6	30481713
23,00	20	180	12	50	130	120	6	30481714
24,00	20	180	12	50	130	120	6	30481715
25,00	20	180	12	50	130	120	6	30481716
26,00	20	180	12	50	130	120	6	30481717
27,00	20	180	12	50	130	120	6	30481718
28,00	25	200	12	56	144	130	6	30481719
29,00	25	200	12	56	144	130	6	30481720
30,00	25	200	12	56	144	130	8	30481721
31,00	25	200	12	56	144	130	8	30481722
32,00	25	200	12	56	144	130	8	30481723
33,00	25	200	12	56	144	130	8	30481724
34,00	25	200	12	56	144	130	8	30481725
35,00	25	200	12	56	144	130	8	30481726
36,00	25	200	12	56	144	130	8	30481727
37,00	25	200	12	56	144	130	8	30481728
38,00	25	200	12	56	144	130	8	30481729
39,00	25	200	12	56	144	130	8	30481730
40,00	25	200	12	56	144	130	8	30481731

Dimensions in mm. Cutting data see page 367 ff.

Intermediate diameters and special tolerances can be ordered by the overview pages for configurable series on page 80.

MR reamers, overview

Configurable series for through bore, fixed, expandable and finely adjustable design with brazed blades

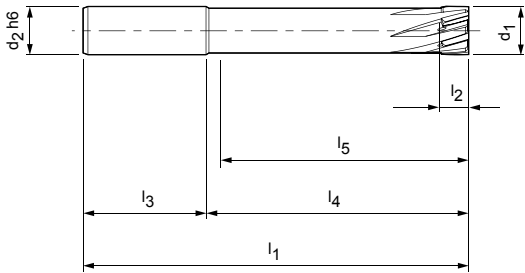

MR 01, fixed design

	P	1	2	3	4	5	6	M	1	2	3	K	1	2	3	N	1	2	3	4	S	1	2	3	4	5	H	1	2
041610																													
041611		■	■	■		■							■	■	■		■	■		■									
041612		■	■	■		■							■	■	■		■	■		■									
041613		■	■	■		■							■	■	■		■	■		■									



MR 02, expandable design

	P	1	2	3	4	5	6	M	1	2	3	K	1	2	3	N	1	2	3	4	S	1	2	3	4	5	H	1	2
041710																													
041711		■	■	■		■							■	■	■		■	■		■									
041712		■	■	■		■							■	■	■		■	■		■									
041713		■	■	■		■							■	■	■		■	■		■									



MR 03, finely adjustable design

	P	1	2	3	4	5	6	M	1	2	3	K	1	2	3	N	1	2	3	4	S	1	2	3	4	5	H	1	2
041810																													
041811		■	■	■		■							■	■	■		■	■		■									
041812		■	■	■		■							■	■	■		■	■		■									
041813		■	■	■		■							■	■	■		■	■		■									



Order example:

1. BECK product code

0 4 1 6 1 1

BECK product code

2. Diameter

- 1 2 . 2 6 0

Bore diameter

3. Tolerance

I T 9

IT or tolerance in µm

Design:	041610 041710 041810	041611 041711 041811	041612 041712 041812	041613 041713 041813
Diameter:	7,700-40,200 mm	7,700-40,200 mm	7,700-40,200 mm	7,700-40,200 mm
Cutting direction:	Right-hand cutting	Right-hand cutting	Right-hand cutting	Right-hand cutting
Cutting material:	Carbide, uncoated	Carbide, BSP coated	Cermet, uncoated	Cermet, coated
Flute direction:	Left-hand fluted	Left-hand fluted	Left-hand fluted	Left-hand fluted
Geometry:	HPC geometry	HPC geometry	HPC geometry	HPC geometry

MR 01, MR 02, MR 03

Dimensions							z
d ₁	d ₂ h6	l ₁	l ₂	l ₃	l ₄	l ₅	
7,700-8,200	12	120	8	45	75	70	4
8,201-8,700	12	120	8	45	75	70	4
8,701-9,200	12	120	8	45	75	70	4
9,201-9,700	12	120	8	45	75	70	4
9,701-10,200	12	120	8	45	75	70	6
10,201-10,700	12	120	8	45	75	70	6
10,701-11,200	12	120	8	45	75	70	6
11,201-11,700	12	120	8	45	75	70	6
11,701-12,200	16	140	8	48	92	87	6
12,201-12,700	16	140	8	48	92	87	6
12,701-13,200	16	140	8	48	92	87	6
13,201-14,200	16	140	8	48	92	87	6
14,201-15,200	16	140	8	48	92	87	6
15,201-16,200	16	140	8	48	92	87	6
16,201-17,200	16	140	8	48	92	87	6
17,201-18,200	20	160	12	50	110	105	6
18,201-19,200	20	160	12	50	110	105	6
19,201-20,200	20	160	12	50	110	105	6
20,201-21,200	20	160	12	50	110	105	6
21,201-22,200	20	160	12	50	110	105	6
22,201-23,200	20	180	12	50	130	125	6
23,201-24,200	20	180	12	50	130	125	6
24,201-25,200	20	180	12	50	130	125	6
25,201-26,200	20	180	12	50	130	125	6
26,201-27,200	20	180	12	50	130	125	6
27,201-28,200	25	200	12	56	144	139	6
28,201-29,200	25	200	12	56	144	139	6
29,201-30,200	25	200	12	56	144	139	8
30,201-31,200	25	200	12	56	144	139	8
31,201-32,200	25	200	12	56	144	139	8
32,201-33,200	25	200	12	56	144	139	8
33,201-34,200	25	200	12	56	144	139	8
34,201-35,200	25	200	12	56	144	139	8
35,201-36,200	25	200	12	56	144	139	8
36,201-37,200	25	200	12	56	144	139	8
37,201-38,200	25	200	12	56	144	139	8
38,201-39,200	25	200	12	56	144	139	8
39,201-40,200	25	200	12	56	144	139	8

Dimensions in mm.

Cutting data see page 367 ff.

MR 01 | 041650

Preferred series for blind bore, fixed design, with brazed blades

Design:

Diameter:
Cutting direction:
Cutting material:
Flute direction:
Geometry:

8,00-40,00 mm
Right-hand cutting
Carbide, uncoated
Straight fluted
HPC geometry

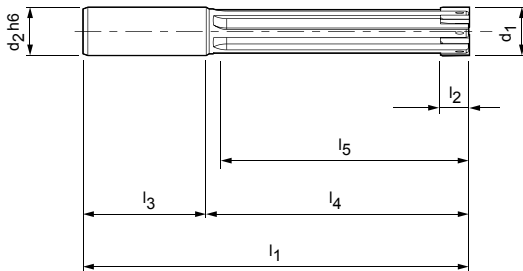

Dimensions							z	Order No.
$d_1 H7$	$d_2 h6$	l_1	l_2	l_3	l_4	l_5		
8,00	12	120	8	45	75	64	4	30480799
8,50	12	120	8	45	75	64	4	30480800
9,00	12	120	8	45	75	64	4	30480801
9,50	12	120	8	45	75	65	4	30480802
10,00	12	120	8	45	75	65	6	30480803
10,50	12	120	8	45	75	65	6	30480804
11,00	12	120	8	45	75	65	6	30480805
11,50	12	120	8	45	75	65	6	30480806
12,00	16	140	8	48	92	80	6	30480807
12,50	16	140	8	48	92	80	6	30480808
13,00	16	140	8	48	92	80	6	30480809
14,00	16	140	8	48	92	80	6	30480810
15,00	16	140	8	48	92	80	6	30480811
16,00	16	140	8	48	92	80	6	30480812
17,00	16	140	8	48	92	80	6	30480813
18,00	20	160	12	50	110	98	6	30480814
19,00	20	160	12	50	110	99	6	30480815
20,00	20	160	12	50	110	100	6	30480816
21,00	20	160	12	50	110	100	6	30480817
22,00	20	160	12	50	110	100	6	30480818
23,00	20	180	12	50	130	120	6	30480819
24,00	20	180	12	50	130	120	6	30480820
25,00	20	180	12	50	130	120	6	30480821
26,00	20	180	12	50	130	120	6	30480822
27,00	20	180	12	50	130	120	6	30480823
28,00	25	200	12	56	144	130	6	30480824
29,00	25	200	12	56	144	130	6	30480825
30,00	25	200	12	56	144	130	8	30480826
31,00	25	200	12	56	144	130	8	30480827
32,00	25	200	12	56	144	130	8	30480828
33,00	25	200	12	56	144	130	8	30480829
34,00	25	200	12	56	144	130	8	30480830
35,00	25	200	12	56	144	130	8	30480831
36,00	25	200	12	56	144	130	8	30480832
37,00	25	200	12	56	144	130	8	30480833
38,00	25	200	12	56	144	130	8	30480834
39,00	25	200	12	56	144	130	8	30480835
40,00	25	200	12	56	144	130	8	30480836

Dimensions in mm. Cutting data see page 367 ff.

Intermediate diameters and special tolerances can be ordered by the overview pages for configurable series on page 94.

MR 01 | 041651

Preferred series for blind bore, fixed design, with brazed blades

Design:

Diameter:
Cutting direction:
Cutting material:
Flute direction:
Geometry:

8,00-40,00 mm
Right-hand cutting
Carbide, BSP coated
Straight fluted
HPC geometry

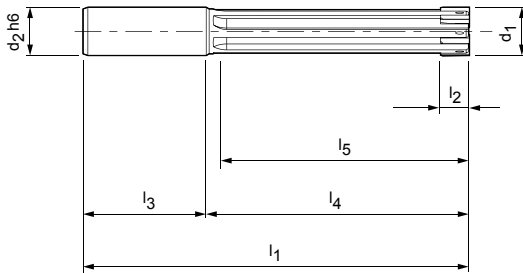

Dimensions							z	Order No.
$d_1 H7$	$d_2 h6$	l_1	l_2	l_3	l_4	l_5		
8,00	12	120	8	45	75	64	4	30480837
8,50	12	120	8	45	75	64	4	30480838
9,00	12	120	8	45	75	64	4	30480839
9,50	12	120	8	45	75	65	4	30480840
10,00	12	120	8	45	75	65	6	30480841
10,50	12	120	8	45	75	65	6	30480842
11,00	12	120	8	45	75	65	6	30480843
11,50	12	120	8	45	75	65	6	30480844
12,00	16	140	8	48	92	80	6	30480845
12,50	16	140	8	48	92	80	6	30480846
13,00	16	140	8	48	92	80	6	30480847
14,00	16	140	8	48	92	80	6	30480848
15,00	16	140	8	48	92	80	6	30480849
16,00	16	140	8	48	92	80	6	30480850
17,00	16	140	8	48	92	80	6	30480851
18,00	20	160	12	50	110	98	6	30480852
19,00	20	160	12	50	110	99	6	30480853
20,00	20	160	12	50	110	100	6	30480854
21,00	20	160	12	50	110	100	6	30480855
22,00	20	160	12	50	110	100	6	30480856
23,00	20	180	12	50	130	120	6	30480857
24,00	20	180	12	50	130	120	6	30480858
25,00	20	180	12	50	130	120	6	30480859
26,00	20	180	12	50	130	120	6	30480860
27,00	20	180	12	50	130	120	6	30480861
28,00	25	200	12	56	144	130	6	30480862
29,00	25	200	12	56	144	130	6	30480863
30,00	25	200	12	56	144	130	8	30480864
31,00	25	200	12	56	144	130	8	30480865
32,00	25	200	12	56	144	130	8	30480866
33,00	25	200	12	56	144	130	8	30480867
34,00	25	200	12	56	144	130	8	30480868
35,00	25	200	12	56	144	130	8	30480869
36,00	25	200	12	56	144	130	8	30480870
37,00	25	200	12	56	144	130	8	30480871
38,00	25	200	12	56	144	130	8	30480872
39,00	25	200	12	56	144	130	8	30480873
40,00	25	200	12	56	144	130	8	30480874

Dimensions in mm. Cutting data see page 367 ff.

Intermediate diameters and special tolerances can be ordered by the overview pages for configurable series on page 94.

MR 01 | 041652

Preferred series for blind bore, fixed design, with brazed blades

Design:

Diameter:
Cutting direction:
Cutting material:
Flute direction:
Geometry:

8,00-40,00 mm
Right-hand cutting
Cermet, uncoated
Straight fluted
HPC geometry

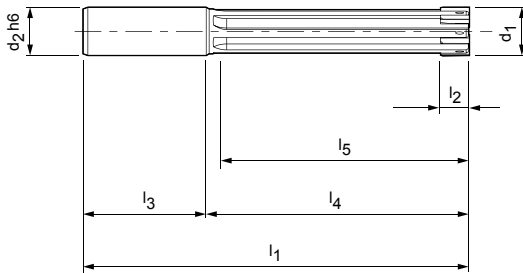

Dimensions							z	Order No.
$d_1 H7$	$d_2 h6$	l_1	l_2	l_3	l_4	l_5		
8,00	12	120	8	45	75	64	4	30480875
8,50	12	120	8	45	75	64	4	30480876
9,00	12	120	8	45	75	64	4	30480877
9,50	12	120	8	45	75	65	4	30480878
10,00	12	120	8	45	75	65	6	30480879
10,50	12	120	8	45	75	65	6	30480880
11,00	12	120	8	45	75	65	6	30480881
11,50	12	120	8	45	75	65	6	30480882
12,00	16	140	8	48	92	80	6	30480883
12,50	16	140	8	48	92	80	6	30480884
13,00	16	140	8	48	92	80	6	30480885
14,00	16	140	8	48	92	80	6	30480886
15,00	16	140	8	48	92	80	6	30480887
16,00	16	140	8	48	92	80	6	30480888
17,00	16	140	8	48	92	80	6	30480889
18,00	20	160	12	50	110	98	6	30480890
19,00	20	160	12	50	110	99	6	30480891
20,00	20	160	12	50	110	100	6	30480892
21,00	20	160	12	50	110	100	6	30480893
22,00	20	160	12	50	110	100	6	30480894
23,00	20	180	12	50	130	120	6	30480895
24,00	20	180	12	50	130	120	6	30480896
25,00	20	180	12	50	130	120	6	30480897
26,00	20	180	12	50	130	120	6	30480898
27,00	20	180	12	50	130	120	6	30480899
28,00	25	200	12	56	144	130	6	30480900
29,00	25	200	12	56	144	130	6	30480901
30,00	25	200	12	56	144	130	8	30480902
31,00	25	200	12	56	144	130	8	30480903
32,00	25	200	12	56	144	130	8	30480904
33,00	25	200	12	56	144	130	8	30480905
34,00	25	200	12	56	144	130	8	30480906
35,00	25	200	12	56	144	130	8	30480907
36,00	25	200	12	56	144	130	8	30480908
37,00	25	200	12	56	144	130	8	30480909
38,00	25	200	12	56	144	130	8	30480910
39,00	25	200	12	56	144	130	8	30480911
40,00	25	200	12	56	144	130	8	30480912

Dimensions in mm. Cutting data see page 367 ff.

Intermediate diameters and special tolerances can be ordered by the overview pages for configurable series on page 94.

MR 01 | 041653

Preferred series for blind bore, fixed design, with brazed blades

Design:

Diameter:
Cutting direction:
Cutting material:
Flute direction:
Geometry:

8,00-40,00 mm
Right-hand cutting
Cermet, coated
Straight fluted
HPC geometry

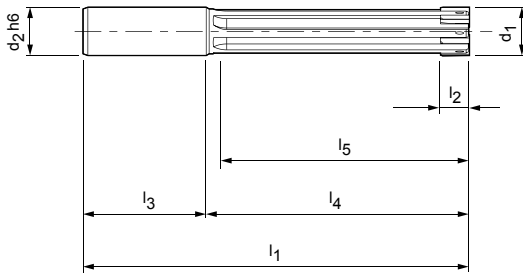

Dimensions							z	Order No.
$d_1\ H7$	$d_2\ h6$	l_1	l_2	l_3	l_4	l_5		
8,00	12	120	8	45	75	64	4	30480913
8,50	12	120	8	45	75	64	4	30480914
9,00	12	120	8	45	75	64	4	30480915
9,50	12	120	8	45	75	65	4	30480916
10,00	12	120	8	45	75	65	6	30480917
10,50	12	120	8	45	75	65	6	30480918
11,00	12	120	8	45	75	65	6	30480919
11,50	12	120	8	45	75	65	6	30480920
12,00	16	140	8	48	92	80	6	30480921
12,50	16	140	8	48	92	80	6	30480922
13,00	16	140	8	48	92	80	6	30480923
14,00	16	140	8	48	92	80	6	30480924
15,00	16	140	8	48	92	80	6	30480925
16,00	16	140	8	48	92	80	6	30480926
17,00	16	140	8	48	92	80	6	30480927
18,00	20	160	12	50	110	98	6	30480928
19,00	20	160	12	50	110	99	6	30480929
20,00	20	160	12	50	110	100	6	30480930
21,00	20	160	12	50	110	100	6	30480931
22,00	20	160	12	50	110	100	6	30480932
23,00	20	180	12	50	130	120	6	30480933
24,00	20	180	12	50	130	120	6	30480934
25,00	20	180	12	50	130	120	6	30480935
26,00	20	180	12	50	130	120	6	30480936
27,00	20	180	12	50	130	120	6	30480937
28,00	25	200	12	56	144	130	6	30480938
29,00	25	200	12	56	144	130	6	30480939
30,00	25	200	12	56	144	130	8	30480940
31,00	25	200	12	56	144	130	8	30480941
32,00	25	200	12	56	144	130	8	30480942
33,00	25	200	12	56	144	130	8	30480943
34,00	25	200	12	56	144	130	8	30480944
35,00	25	200	12	56	144	130	8	30480945
36,00	25	200	12	56	144	130	8	30480946
37,00	25	200	12	56	144	130	8	30480947
38,00	25	200	12	56	144	130	8	30480948
39,00	25	200	12	56	144	130	8	30480949
40,00	25	200	12	56	144	130	8	30480950

Dimensions in mm. Cutting data see page 367 ff.

Intermediate diameters and special tolerances can be ordered by the overview pages for configurable series on page 94.

MR 02 I 041750

Preferred series for blind bore, expandable design, with brazed blades

Design:

Diameter:
Cutting direction:
Cutting material:
Flute direction:
Geometry:

8,00-40,00 mm
Right-hand cutting
Carbide, uncoated
Straight fluted
HPC geometry

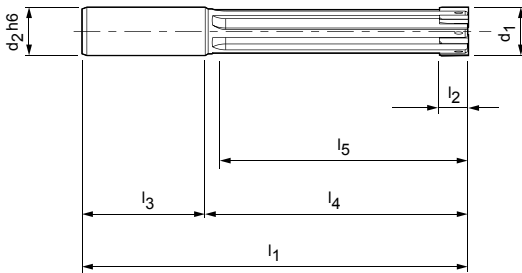

Dimensions							z	Order No.
$d_1 H7$	$d_2 h6$	l_1	l_2	l_3	l_4	l_5		
8,00	12	120	8	45	75	64	4	30481272
8,50	12	120	8	45	75	64	4	30481273
9,00	12	120	8	45	75	64	4	30481274
9,50	12	120	8	45	75	65	4	30481275
10,00	12	120	8	45	75	65	6	30481276
10,50	12	120	8	45	75	65	6	30481277
11,00	12	120	8	45	75	65	6	30481278
11,50	12	120	8	45	75	65	6	30481279
12,00	16	140	8	48	92	80	6	30481280
12,50	16	140	8	48	92	80	6	30481281
13,00	16	140	8	48	92	80	6	30481282
14,00	16	140	8	48	92	80	6	30481283
15,00	16	140	8	48	92	80	6	30481284
16,00	16	140	8	48	92	80	6	30481285
17,00	16	140	8	48	92	80	6	30481286
18,00	20	160	12	50	110	98	6	30481287
19,00	20	160	12	50	110	99	6	30481288
20,00	20	160	12	50	110	100	6	30481289
21,00	20	160	12	50	110	100	6	30481290
22,00	20	160	12	50	110	100	6	30481291
23,00	20	180	12	50	130	120	6	30481292
24,00	20	180	12	50	130	120	6	30481293
25,00	20	180	12	50	130	120	6	30481294
26,00	20	180	12	50	130	120	6	30481295
27,00	20	180	12	50	130	120	6	30481296
28,00	25	200	12	56	144	130	6	30481297
29,00	25	200	12	56	144	130	6	30481298
30,00	25	200	12	56	144	130	8	30481299
31,00	25	200	12	56	144	130	8	30481300
32,00	25	200	12	56	144	130	8	30481301
33,00	25	200	12	56	144	130	8	30481302
34,00	25	200	12	56	144	130	8	30481303
35,00	25	200	12	56	144	130	8	30481304
36,00	25	200	12	56	144	130	8	30481305
37,00	25	200	12	56	144	130	8	30481306
38,00	25	200	12	56	144	130	8	30481307
39,00	25	200	12	56	144	130	8	30481308
40,00	25	200	12	56	144	130	8	30481309

Dimensions in mm. Cutting data see page 367 ff.

Intermediate diameters and special tolerances can be ordered by the overview pages for configurable series on page 94.

MR 02 I 041751

Preferred series for blind bore, expandable design, with brazed blades

Design:

Diameter:
Cutting direction:
Cutting material:
Flute direction:
Geometry:

8,00-40,00 mm
Right-hand cutting
Carbide, BSP coated
Straight fluted
HPC geometry

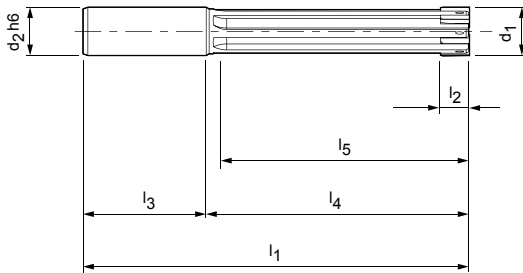

Dimensions							z	Order No.
$d_1 H7$	$d_2 h6$	l_1	l_2	l_3	l_4	l_5		
8,00	12	120	8	45	75	64	4	30481310
8,50	12	120	8	45	75	64	4	30481311
9,00	12	120	8	45	75	64	4	30481312
9,50	12	120	8	45	75	65	4	30481313
10,00	12	120	8	45	75	65	6	30481314
10,50	12	120	8	45	75	65	6	30481315
11,00	12	120	8	45	75	65	6	30481316
11,50	12	120	8	45	75	65	6	30481317
12,00	16	140	8	48	92	80	6	30481318
12,50	16	140	8	48	92	80	6	30481319
13,00	16	140	8	48	92	80	6	30481320
14,00	16	140	8	48	92	80	6	30481321
15,00	16	140	8	48	92	80	6	30481322
16,00	16	140	8	48	92	80	6	30481323
17,00	16	140	8	48	92	80	6	30481324
18,00	20	160	12	50	110	98	6	30481325
19,00	20	160	12	50	110	99	6	30481326
20,00	20	160	12	50	110	100	6	30481327
21,00	20	160	12	50	110	100	6	30481328
22,00	20	160	12	50	110	100	6	30481329
23,00	20	180	12	50	130	120	6	30481330
24,00	20	180	12	50	130	120	6	30481331
25,00	20	180	12	50	130	120	6	30481332
26,00	20	180	12	50	130	120	6	30481333
27,00	20	180	12	50	130	120	6	30481334
28,00	25	200	12	56	144	130	6	30481335
29,00	25	200	12	56	144	130	6	30481336
30,00	25	200	12	56	144	130	8	30481337
31,00	25	200	12	56	144	130	8	30481338
32,00	25	200	12	56	144	130	8	30481339
33,00	25	200	12	56	144	130	8	30481341
34,00	25	200	12	56	144	130	8	30481342
35,00	25	200	12	56	144	130	8	30481343
36,00	25	200	12	56	144	130	8	30481344
37,00	25	200	12	56	144	130	8	30481345
38,00	25	200	12	56	144	130	8	30481346
39,00	25	200	12	56	144	130	8	30481347
40,00	25	200	12	56	144	130	8	30481348

Dimensions in mm. Cutting data see page 367 ff.

Intermediate diameters and special tolerances can be ordered by the overview pages for configurable series on page 94.

MR 02 I 041752

Preferred series for blind bore, expandable design, with brazed blades

Design:

Diameter:
Cutting direction:
Cutting material:
Flute direction:
Geometry:

8,00-40,00 mm
Right-hand cutting
Cermet, uncoated
Straight fluted
HPC geometry

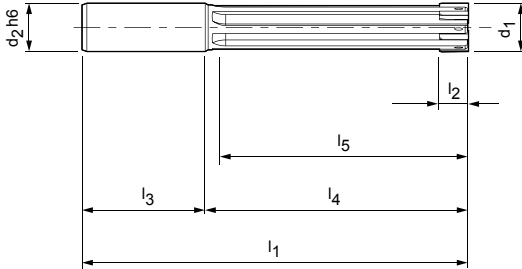

Dimensions							z	Order No.
$d_1 H7$	$d_2 h6$	l_1	l_2	l_3	l_4	l_5		
8,00	12	120	8	45	75	64	4	30481349
8,50	12	120	8	45	75	64	4	30481350
9,00	12	120	8	45	75	64	4	30481351
9,50	12	120	8	45	75	65	4	30481352
10,00	12	120	8	45	75	65	6	30481353
10,50	12	120	8	45	75	65	6	30481354
11,00	12	120	8	45	75	65	6	30481355
11,50	12	120	8	45	75	65	6	30481356
12,00	16	140	8	48	92	80	6	30481357
12,50	16	140	8	48	92	80	6	30481358
13,00	16	140	8	48	92	80	6	30481359
14,00	16	140	8	48	92	80	6	30481360
15,00	16	140	8	48	92	80	6	30481361
16,00	16	140	8	48	92	80	6	30481362
17,00	16	140	8	48	92	80	6	30481363
18,00	20	160	12	50	110	98	6	30481364
19,00	20	160	12	50	110	99	6	30481365
20,00	20	160	12	50	110	100	6	30481366
21,00	20	160	12	50	110	100	6	30481367
22,00	20	160	12	50	110	100	6	30481368
23,00	20	180	12	50	130	120	6	30481369
24,00	20	180	12	50	130	120	6	30481370
25,00	20	180	12	50	130	120	6	30481371
26,00	20	180	12	50	130	120	6	30481372
27,00	20	180	12	50	130	120	6	30481373
28,00	25	200	12	56	144	130	6	30481374
29,00	25	200	12	56	144	130	6	30481375
30,00	25	200	12	56	144	130	8	30481376
31,00	25	200	12	56	144	130	8	30481377
32,00	25	200	12	56	144	130	8	30481378
33,00	25	200	12	56	144	130	8	30481379
34,00	25	200	12	56	144	130	8	30481380
35,00	25	200	12	56	144	130	8	30481381
36,00	25	200	12	56	144	130	8	30481382
37,00	25	200	12	56	144	130	8	30481383
38,00	25	200	12	56	144	130	8	30481384
39,00	25	200	12	56	144	130	8	30481385
40,00	25	200	12	56	144	130	8	30481386

Dimensions in mm. Cutting data see page 367 ff.

Intermediate diameters and special tolerances can be ordered by the overview pages for configurable series on page 94.

MR 02 I 041753

Preferred series for blind bore, expandable design, with brazed blades

Design:

Diameter:
Cutting direction:
Cutting material:
Flute direction:
Geometry:

8,00-40,00 mm
Right-hand cutting
Cermet, coated
Straight fluted
HPC geometry

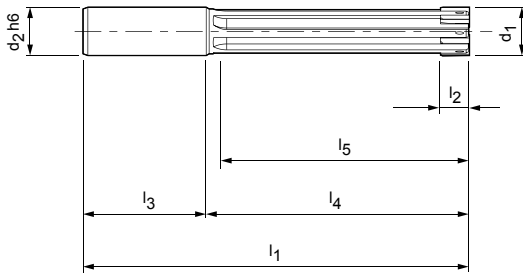

Dimensions							z	Order No.
$d_1 H7$	$d_2 h6$	l_1	l_2	l_3	l_4	l_5		
8,00	12	120	8	45	75	64	4	30481387
8,50	12	120	8	45	75	64	4	30481388
9,00	12	120	8	45	75	64	4	30481389
9,50	12	120	8	45	75	65	4	30481390
10,00	12	120	8	45	75	65	6	30481391
10,50	12	120	8	45	75	65	6	30481392
11,00	12	120	8	45	75	65	6	30481393
11,50	12	120	8	45	75	65	6	30481394
12,00	16	140	8	48	92	80	6	30481395
12,50	16	140	8	48	92	80	6	30481396
13,00	16	140	8	48	92	80	6	30481397
14,00	16	140	8	48	92	80	6	30481398
15,00	16	140	8	48	92	80	6	30481399
16,00	16	140	8	48	92	80	6	30481400
17,00	16	140	8	48	92	80	6	30481401
18,00	20	160	12	50	110	98	6	30481402
19,00	20	160	12	50	110	99	6	30481403
20,00	20	160	12	50	110	100	6	30481404
21,00	20	160	12	50	110	100	6	30481405
22,00	20	160	12	50	110	100	6	30481406
23,00	20	180	12	50	130	120	6	30481407
24,00	20	180	12	50	130	120	6	30481408
25,00	20	180	12	50	130	120	6	30481409
26,00	20	180	12	50	130	120	6	30481410
27,00	20	180	12	50	130	120	6	30481411
28,00	25	200	12	56	144	130	6	30481412
29,00	25	200	12	56	144	130	6	30481413
30,00	25	200	12	56	144	130	8	30481414
31,00	25	200	12	56	144	130	8	30481415
32,00	25	200	12	56	144	130	8	30481416
33,00	25	200	12	56	144	130	8	30481417
34,00	25	200	12	56	144	130	8	30481418
35,00	25	200	12	56	144	130	8	30481419
36,00	25	200	12	56	144	130	8	30481420
37,00	25	200	12	56	144	130	8	30481421
38,00	25	200	12	56	144	130	8	30481422
39,00	25	200	12	56	144	130	8	30481423
40,00	25	200	12	56	144	130	8	30481424

Dimensions in mm. Cutting data see page 367 ff.

Intermediate diameters and special tolerances can be ordered by the overview pages for configurable series on page 94.

MR 03 | 041850

Preferred series for blind bore, finely adjustable design, with brazed blades

Design:

Diameter:
Cutting direction:
Cutting material:
Flute direction:
Geometry:

8,00-40,00 mm
Right-hand cutting
Carbide, uncoated
Straight fluted
HPC geometry

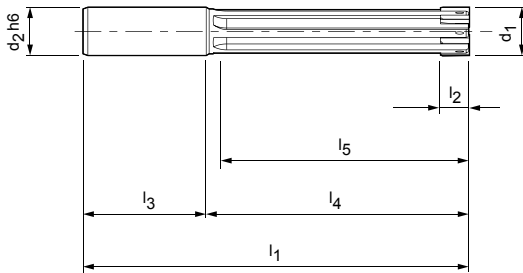

Dimensions							z	Order No.
d_1 H7	d_2 h6	l_1	l_2	l_3	l_4	l_5		
8,00	12	120	8	45	75	64	4	30481732
8,50	12	120	8	45	75	64	4	30481733
9,00	12	120	8	45	75	64	4	30481734
9,50	12	120	8	45	75	65	4	30481735
10,00	12	120	8	45	75	65	6	30481736
10,50	12	120	8	45	75	65	6	30481737
11,00	12	120	8	45	75	65	6	30481738
11,50	12	120	8	45	75	65	6	30481739
12,00	16	140	8	48	92	80	6	30481740
12,50	16	140	8	48	92	80	6	30481741
13,00	16	140	8	48	92	80	6	30481742
14,00	16	140	8	48	92	80	6	30481743
15,00	16	140	8	48	92	80	6	30481744
16,00	16	140	8	48	92	80	6	30481745
17,00	16	140	8	48	92	80	6	30481746
18,00	20	160	12	50	110	98	6	30481747
19,00	20	160	12	50	110	99	6	30481748
20,00	20	160	12	50	110	100	6	30481749
21,00	20	160	12	50	110	100	6	30481750
22,00	20	160	12	50	110	100	6	30481751
23,00	20	180	12	50	130	120	6	30481752
24,00	20	180	12	50	130	120	6	30481753
25,00	20	180	12	50	130	120	6	30481754
26,00	20	180	12	50	130	120	6	30481755
27,00	20	180	12	50	130	120	6	30481756
28,00	25	200	12	56	144	130	6	30481757
29,00	25	200	12	56	144	130	6	30481758
30,00	25	200	12	56	144	130	8	30481759
31,00	25	200	12	56	144	130	8	30481760
32,00	25	200	12	56	144	130	8	30481761
33,00	25	200	12	56	144	130	8	30481762
34,00	25	200	12	56	144	130	8	30481763
35,00	25	200	12	56	144	130	8	30481764
36,00	25	200	12	56	144	130	8	30481765
37,00	25	200	12	56	144	130	8	30481766
38,00	25	200	12	56	144	130	8	30481767
39,00	25	200	12	56	144	130	8	30481768
40,00	25	200	12	56	144	130	8	30481769

Dimensions in mm. Cutting data see page 367 ff.

Intermediate diameters and special tolerances can be ordered by the overview pages for configurable series on page 94.

MR 03 | 041851

Preferred series for blind bore, finely adjustable design, with brazed blades

Design:

Diameter:
Cutting direction:
Cutting material:
Flute direction:
Geometry:

8,00-40,00 mm
Right-hand cutting
Carbide, BSP coated
Straight fluted
HPC geometry

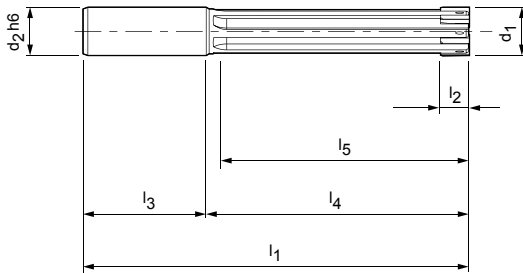

Dimensions							z	Order No.
$d_1 H7$	$d_2 h6$	l_1	l_2	l_3	l_4	l_5		
8,00	12	120	8	45	75	64	4	30481770
8,50	12	120	8	45	75	64	4	30481771
9,00	12	120	8	45	75	64	4	30481772
9,50	12	120	8	45	75	65	4	30481773
10,00	12	120	8	45	75	65	6	30481774
10,50	12	120	8	45	75	65	6	30481775
11,00	12	120	8	45	75	65	6	30481776
11,50	12	120	8	45	75	65	6	30481777
12,00	16	140	8	48	92	80	6	30481778
12,50	16	140	8	48	92	80	6	30481779
13,00	16	140	8	48	92	80	6	30481780
14,00	16	140	8	48	92	80	6	30481781
15,00	16	140	8	48	92	80	6	30481782
16,00	16	140	8	48	92	80	6	30481783
17,00	16	140	8	48	92	80	6	30481784
18,00	20	160	12	50	110	98	6	30481785
19,00	20	160	12	50	110	99	6	30481786
20,00	20	160	12	50	110	100	6	30481787
21,00	20	160	12	50	110	100	6	30481788
22,00	20	160	12	50	110	100	6	30481789
23,00	20	180	12	50	130	120	6	30481790
24,00	20	180	12	50	130	120	6	30481791
25,00	20	180	12	50	130	120	6	30481792
26,00	20	180	12	50	130	120	6	30481793
27,00	20	180	12	50	130	120	6	30481794
28,00	25	200	12	56	144	130	6	30481795
29,00	25	200	12	56	144	130	6	30481796
30,00	25	200	12	56	144	130	8	30481797
31,00	25	200	12	56	144	130	8	30481798
32,00	25	200	12	56	144	130	8	30481799
33,00	25	200	12	56	144	130	8	30481800
34,00	25	200	12	56	144	130	8	30481801
35,00	25	200	12	56	144	130	8	30481802
36,00	25	200	12	56	144	130	8	30481803
37,00	25	200	12	56	144	130	8	30481804
38,00	25	200	12	56	144	130	8	30481805
39,00	25	200	12	56	144	130	8	30481806
40,00	25	200	12	56	144	130	8	30481807

Dimensions in mm. Cutting data see page 367 ff.

Intermediate diameters and special tolerances can be ordered by the overview pages for configurable series on page 94.

MR 03 | 041852

Preferred series for blind bore, finely adjustable design, with brazed blades

Design:

Diameter:
Cutting direction:
Cutting material:
Flute direction:
Geometry:

8,00-40,00 mm
Right-hand cutting
Cermet, uncoated
Straight fluted
HPC geometry

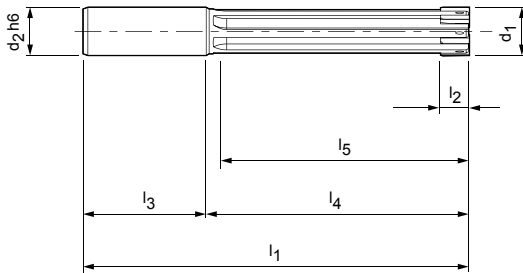

Dimensions							z	Order No.
$d_1\ H7$	$d_2\ h6$	l_1	l_2	l_3	l_4	l_5		
8,00	12	120	8	45	75	64	4	30481808
8,50	12	120	8	45	75	64	4	30481809
9,00	12	120	8	45	75	64	4	30481810
9,50	12	120	8	45	75	65	4	30481811
10,00	12	120	8	45	75	65	6	30481812
10,50	12	120	8	45	75	65	6	30481813
11,00	12	120	8	45	75	65	6	30481814
11,50	12	120	8	45	75	65	6	30481815
12,00	16	140	8	48	92	80	6	30481816
12,50	16	140	8	48	92	80	6	30481817
13,00	16	140	8	48	92	80	6	30481818
14,00	16	140	8	48	92	80	6	30481819
15,00	16	140	8	48	92	80	6	30481820
16,00	16	140	8	48	92	80	6	30481821
17,00	16	140	8	48	92	80	6	30481822
18,00	20	160	12	50	110	98	6	30481823
19,00	20	160	12	50	110	99	6	30481824
20,00	20	160	12	50	110	100	6	30481825
21,00	20	160	12	50	110	100	6	30481826
22,00	20	160	12	50	110	100	6	30481827
23,00	20	180	12	50	130	120	6	30481828
24,00	20	180	12	50	130	120	6	30481829
25,00	20	180	12	50	130	120	6	30481830
26,00	20	180	12	50	130	120	6	30481831
27,00	20	180	12	50	130	120	6	30481832
28,00	25	200	12	56	144	130	6	30481833
29,00	25	200	12	56	144	130	6	30481834
30,00	25	200	12	56	144	130	8	30481835
31,00	25	200	12	56	144	130	8	30481836
32,00	25	200	12	56	144	130	8	30481837
33,00	25	200	12	56	144	130	8	30481838
34,00	25	200	12	56	144	130	8	30481839
35,00	25	200	12	56	144	130	8	30481840
36,00	25	200	12	56	144	130	8	30481841
37,00	25	200	12	56	144	130	8	30481842
38,00	25	200	12	56	144	130	8	30481843
39,00	25	200	12	56	144	130	8	30481844
40,00	25	200	12	56	144	130	8	30481845

Dimensions in mm. Cutting data see page 367 ff.

Intermediate diameters and special tolerances can be ordered by the overview pages for configurable series on page 94.

MR 03 I 041853

Preferred series for blind bore, finely adjustable design, with brazed blades

Design:

Diameter:
Cutting direction:
Cutting material:
Flute direction:
Geometry:

8,00-40,00 mm
Right-hand cutting
Cermet, coated
Straight fluted
HPC geometry

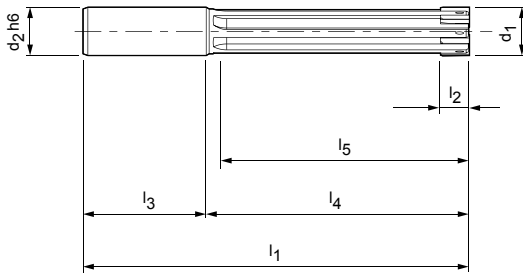

Dimensions							z	Order No.
$d_1 H7$	$d_2 h6$	l_1	l_2	l_3	l_4	l_5		
8,00	12	120	8	45	75	64	4	30481846
8,50	12	120	8	45	75	64	4	30481847
9,00	12	120	8	45	75	64	4	30481848
9,50	12	120	8	45	75	65	4	30481849
10,00	12	120	8	45	75	65	6	30481850
10,50	12	120	8	45	75	65	6	30481851
11,00	12	120	8	45	75	65	6	30481853
11,50	12	120	8	45	75	65	6	30481854
12,00	16	140	8	48	92	80	6	30481855
12,50	16	140	8	48	92	80	6	30481856
13,00	16	140	8	48	92	80	6	30481857
14,00	16	140	8	48	92	80	6	30481858
15,00	16	140	8	48	92	80	6	30481859
16,00	16	140	8	48	92	80	6	30481860
17,00	16	140	8	48	92	80	6	30481861
18,00	20	160	12	50	110	98	6	30481862
19,00	20	160	12	50	110	99	6	30481863
20,00	20	160	12	50	110	100	6	30481864
21,00	20	160	12	50	110	100	6	30481865
22,00	20	160	12	50	110	100	6	30481866
23,00	20	180	12	50	130	120	6	30481867
24,00	20	180	12	50	130	120	6	30481868
25,00	20	180	12	50	130	120	6	30481869
26,00	20	180	12	50	130	120	6	30481870
27,00	20	180	12	50	130	120	6	30481871
28,00	25	200	12	56	144	130	6	30481872
29,00	25	200	12	56	144	130	6	30481873
30,00	25	200	12	56	144	130	8	30481874
31,00	25	200	12	56	144	130	8	30481875
32,00	25	200	12	56	144	130	8	30481876
33,00	25	200	12	56	144	130	8	30481877
34,00	25	200	12	56	144	130	8	30481878
35,00	25	200	12	56	144	130	8	30481879
36,00	25	200	12	56	144	130	8	30481880
37,00	25	200	12	56	144	130	8	30481881
38,00	25	200	12	56	144	130	8	30481882
39,00	25	200	12	56	144	130	8	30481883
40,00	25	200	12	56	144	130	8	30481884

Dimensions in mm. Cutting data see page 367 ff.

Intermediate diameters and special tolerances can be ordered by the overview pages for configurable series on page 94.

MR reamers, overview

Configurable series for blind bore, fixed, expandable and finely adjustable design with brazed blades

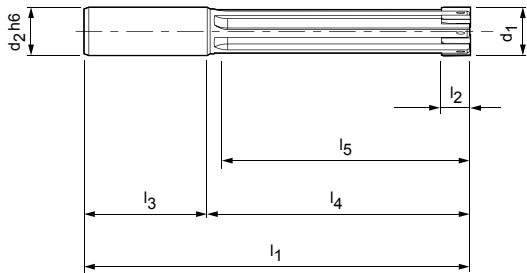

MR 01, fixed design

	P	1	2	3	4	5	6	M	1	2	3	K	1	2	3	N	1	2	3	4	S	1	2	3	4	5	H	1	2
041650																													
041651		■	■	■									■	■	■		■	■			■								
041652		■	■	■									■	■	■		■	■			■								
041653		■	■	■									■	■	■		■	■			■								



MR 02, expandable design

	P	1	2	3	4	5	6	M	1	2	3	K	1	2	3	N	1	2	3	4	S	1	2	3	4	5	H	1	2
041750																													
041751		■	■	■									■	■	■		■	■			■								
041752		■	■	■									■	■	■		■	■			■								
041753		■	■	■									■	■	■		■	■			■								



MR 03, finely adjustable design

	P	1	2	3	4	5	6	M	1	2	3	K	1	2	3	N	1	2	3	4	S	1	2	3	4	5	H	1	2
041850																													
041851		■	■	■									■	■	■		■	■			■								
041852		■	■	■									■	■	■		■	■			■								
041853		■	■	■									■	■	■		■	■			■								



Order example:

1. BECK product code

0 4 1 6 5 1

BECK product code

2. Diameter

- 1 2 . 2 6 0

Bore diameter

3. Tolerance

I T 9

IT or tolerance in µm

Design:	041650 041750 041850	041651 041751 041851	041652 041752 041852	041653 041753 041853
Diameter:	7,700-40,200 mm	7,700-40,200 mm	7,700-40,200 mm	7,700-40,200 mm
Cutting direction:	Right-hand cutting	Right-hand cutting	Right-hand cutting	Right-hand cutting
Cutting material:	Carbide, uncoated	Carbide, BSP coated	Cermet, uncoated	Cermet, coated
Flute direction:	Straight fluted	Straight fluted	Straight fluted	Straight fluted
Geometry:	HPC geometry	HPC geometry	HPC geometry	HPC geometry

MR 01, MR 02, MR 03

Dimensions							z
d ₁	d ₂ h6	l ₁	l ₂	l ₃	l ₄	l ₅	
7,700-8,200	12	120	8	45	75	64	4
8,201-8,700	12	120	8	45	75	64	4
8,701-9,200	12	120	8	45	75	64	4
9,201-9,700	12	120	8	45	75	65	4
9,701-10,200	12	120	8	45	75	65	6
10,201-10,700	12	120	8	45	75	65	6
10,701-11,200	12	120	8	45	75	65	6
11,201-11,700	12	120	8	45	75	65	6
11,701-12,200	16	140	8	48	92	80	6
12,201-12,700	16	140	8	48	92	80	6
12,701-13,200	16	140	8	48	92	80	6
13,201-14,200	16	140	8	48	92	80	6
14,201-15,200	16	140	8	48	92	80	6
15,201-16,200	16	140	8	48	92	80	6
16,201-17,200	16	140	8	48	92	80	6
17,201-18,200	20	160	12	50	110	98	6
18,201-19,200	20	160	12	50	110	99	6
19,201-20,200	20	160	12	50	110	100	6
20,201-21,200	20	160	12	50	110	100	6
21,201-22,200	20	160	12	50	110	100	6
22,201-23,200	20	180	12	50	130	120	6
23,201-24,200	20	180	12	50	130	120	6
24,201-25,200	20	180	12	50	130	120	6
25,201-26,200	20	180	12	50	130	120	6
26,201-27,200	20	180	12	50	130	120	6
27,201-28,200	25	200	12	56	144	130	6
28,201-29,200	25	200	12	56	144	130	6
29,201-30,200	25	200	12	56	144	130	8
30,201-31,200	25	200	12	56	144	130	8
31,201-32,200	25	200	12	56	144	130	8
32,201-33,200	25	200	12	56	144	130	8
33,201-34,200	25	200	12	56	144	130	8
34,201-35,200	25	200	12	56	144	130	8
35,201-36,200	25	200	12	56	144	130	8
36,201-37,200	25	200	12	56	144	130	8
37,201-38,200	25	200	12	56	144	130	8
38,201-39,200	25	200	12	56	144	130	8
39,201-40,200	25	200	12	56	144	130	8

Dimensions in mm.
Cutting data see page 367 ff.





RR REAMERS

Introduction

Product overview	98
------------------	----

Series for through bore

RR 01	040325	100
RR 01	040326	102
RR 01, expandable	040327	104

Series for blind bore

RR 01	040340	106
RR 01	040341	108

PRODUCT OVERVIEW



RR 01

The RR 01 series is specially designed for machining cast iron and steel. It has a patented coolant supply. A sleeve ensures the optimal supply of coolant to the HPC blades.

The range comprises reamers with solid cermet head in the diameter range 3.85 to 20.20 mm. From a diameter range of 20.21 mm the tools are available in a cermet tipped design.

An additional expansion of the range is the expandable variant for machining through bores. It combines the advantages of a solid tool with those of adjustability. The expansion system is suitable for expanding the diameter prior to re-grinding. The re-ground tools also have the same performance as the original, the tool costs are reduced.



RR 01 040325 Solid cermet head	RR 01 040326 Cermet tipped	RR 01 040327 Cermet tipped, expanding design
		
<p>High-performance reamer with solid cermet head, spiral fluted, special coolant supply.</p> <p>ø range: 4.00-20.00 mm</p> <p>Performance LINE</p> <p>BECK NORM</p> <p>P K</p>	<p>Cermet tipped high-performance reamer, left-hand fluted, special coolant supply.</p> <p>ø range: 21.00-40.00 mm</p> <p>Performance LINE</p> <p>BECK NORM</p> <p>P K</p>	<p>Cermet tipped high-performance reamer with expansion system, left-hand fluted, special coolant supply.</p> <p>ø range: 8.00-40.00 mm</p> <p>Performance LINE</p> <p>BECK NORM</p> <p>P K</p>
<p>Page 100</p>	<p>Page 102</p>	<p>Page 104</p>



RR 01 | 040340
Solid cermet head

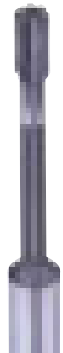

High-performance reamer with solid cermet head, straight fluted, special coolant supply.

Ø range: 4.00-20.00 mm

Perfor-
mance
LINE



P K

RR 01 | 040341
Cermet tipped



Cermet tipped high-performance reamer, straight fluted, special coolant supply.

Ø range: 21.00-40.00 mm

Perfor-
mance
LINE



P K

RR 01 | 040325

Preferred series for through bore, solid cermet head

Design:

Diameter:
Cutting direction:
Cutting material:
Flute direction:
Geometry:

4,00-20,00 mm
Right-hand cutting
Cermet, uncoated
Spiral fluted
HPC, EU spacing

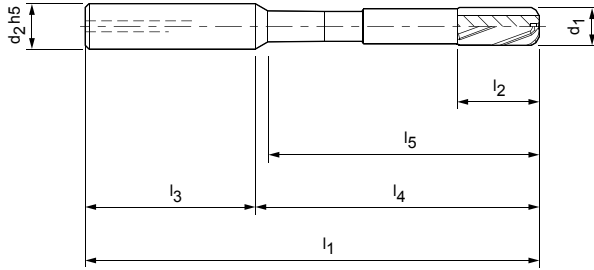

Dimensions							z	Order No.
$d_1 H7$	$d_2 h5$	l_1	l_2	l_3	l_4	l_5		
4,00	10	80	14	40	40	33	4	30109599
4,50	10	80	14	40	40	33	4	30109601
5,00	12	85	14	45	40	33	4	30109603
5,50	12	85	14	45	40	33	4	30109605
6,00	12	85	14	45	40	33	4	30109607
6,50	12	105	14	45	60	52	6	30109609
7,00	12	110	18	45	65	57	6	30109611
7,50	12	110	18	45	65	57	6	30109613
8,00	12	110	18	45	65	57	6	30109615
8,50	12	120	18	45	75	67	6	30109617
9,00	12	120	22	45	75	67	6	30109619
9,50	12	120	22	45	75	67	6	30109621
10,00	12	120	22	45	75	68	6	30109623
10,50	12	120	22	45	75	68	6	30109625
11,00	12	120	22	45	75	68	6	30109627
12,00	12	120	22	45	75	68	6	30109631
13,00	16	130	22	48	82	74	6	30109633
14,00	16	130	23	48	82	74	6	30109635
15,00	16	130	23	48	82	74	6	30109637
16,00	16	130	26	48	82	74	6	30109639
17,00	16	160	26	48	112	105	8	30109641
18,00	16	160	26	48	112	105	8	30109643
19,00	16	160	26	48	112	105	8	30109645
20,00	16	160	26	48	112	105	8	30109647

Dimensions in mm.

Cutting data see page 367 ff.

Information on special designs and other coatings on request.

RR 01 | 040325

Configurable series for through bore, solid cermet head

Design:

Diameter:
Cutting direction:
Cutting material:
Flute direction:
Geometry:

3,850-20,200 mm
Right-hand cutting
Cermet, uncoated
Spiral fluted
HPC, EU spacing

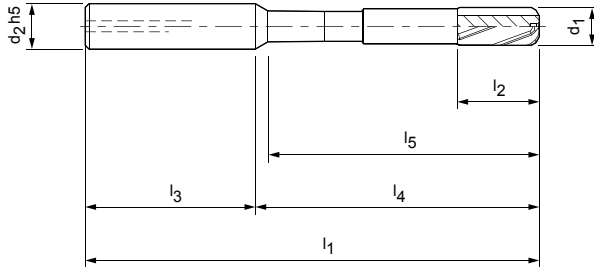

Dimensions							Z
d_1	$d_2 h_5$	l_1	l_2	l_3	l_4	l_5	
3,850-4,350	10	80	14	40	40	33	4
4,351-4,900	10	80	14	40	40	33	4
4,901-5,300	12	85	14	45	40	33	4
5,301-5,700	12	85	14	45	40	33	4
5,701-6,200	12	85	14	45	40	33	4
6,201-6,700	12	105	14	45	60	52	6
6,701-7,200	12	110	18	45	65	57	6
7,201-7,700	12	110	18	45	65	57	6
7,701-8,200	12	110	18	45	65	57	6
8,201-8,700	12	120	18	45	75	67	6
8,701-9,200	12	120	22	45	75	67	6
9,201-9,700	12	120	22	45	75	67	6
9,701-10,200	12	120	22	45	75	68	6
10,201-10,700	12	120	22	45	75	68	6
10,700-11,200	12	120	22	45	75	68	6
11,201-12,200	12	120	22	45	75	68	6
12,201-13,200	16	130	22	48	82	74	6
13,201-14,200	16	130	23	48	82	74	6
14,201-15,200	16	130	23	48	82	74	6
15,201-16,200	16	130	26	48	82	74	6
16,201-17,200	16	160	26	48	112	105	8
17,201-18,200	16	160	26	48	112	105	8
18,201-19,200	16	160	26	48	112	105	8
19,201-20,200	16	160	26	48	112	105	8

Dimensions in mm.

Cutting data see page 367 ff.

Information on special designs and other coatings on request.

RR 01 | 040326

Preferred series for through bore, brazed cermet blades

Design:

Diameter:
Cutting direction:
Cutting material:
Flute direction:
Geometry:

21,00-40,00 mm
Right-hand cutting
Cermet, uncoated
Left-hand fluted
HPC, EU spacing

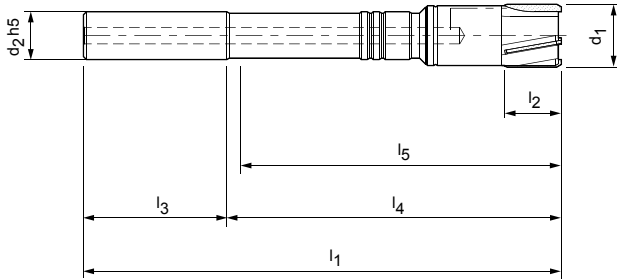

Dimensions							z	Order No.
$d_1 H7$	$d_2 h5$	l_1	l_2	l_3	l_4	l_5		
21,00	16	160	19	48	112	105	6	30109651
22,00	16	160	22	48	112	105	6	30109653
23,00	20	180	22	50	130	122	6	30109655
24,00	20	180	22	50	130	122	6	30109657
25,00	20	180	22	50	130	122	6	30109659
26,00	20	180	22	50	130	122	6	30109661
27,00	20	180	25	50	130	122	6	30109663
28,00	25	180	25	56	124	116	6	30109665
29,00	25	180	25	56	124	116	6	30109667
30,00	25	200	25	56	144	136	8	30109669
31,00	25	200	25	56	144	136	8	30109671
32,00	25	200	25	56	144	136	8	30109673
33,00	25	200	25	56	144	136	8	30109675
34,00	25	200	25	56	144	136	8	30109677
35,00	25	200	25	56	144	136	8	30109679
36,00	25	200	25	56	144	136	8	30109681
37,00	25	200	25	56	144	136	8	30109683
38,00	25	200	25	56	144	136	8	30109685
39,00	25	200	25	56	144	136	8	30109687
40,00	25	200	25	56	144	136	8	30109689

Dimensions in mm.
Cutting data see page 367 ff.
Information on special designs and other coatings on request.

RR 01 | 040326

Configurable series for through bore, brazed cermet blades

Design:

Diameter:
Cutting direction:
Cutting material:
Flute direction:
Geometry:

20,201-40,200 mm
Right-hand cutting
Cermet, uncoated
Left-hand fluted
HPC, EU spacing

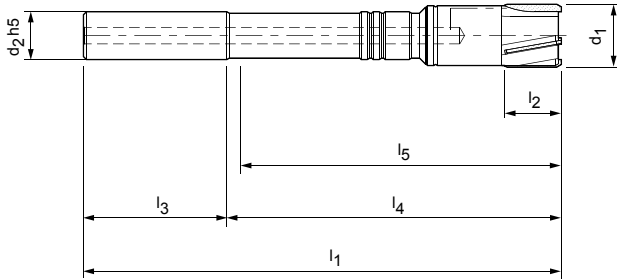

Dimensions							z
d_1	$d_2 h5$	l_1	l_2	l_3	l_4	l_5	
20,201-21,200	16	160	19	48	112	105	6
21,201-22,200	16	160	22	48	112	105	6
22,201-23,200	20	180	22	50	130	122	6
23,201-24,200	20	180	22	50	130	122	6
24,201-25,200	20	180	22	50	130	122	6
25,201-26,200	20	180	22	50	130	122	6
26,201-27,200	20	180	25	50	130	122	6
27,201-28,200	25	180	25	56	124	116	6
28,201-29,200	25	180	25	56	124	116	6
29,201-30,200	25	200	25	56	144	136	8
30,201-31,200	25	200	25	56	144	136	8
31,201-32,200	25	200	25	56	144	136	8
32,201-33,200	25	200	25	56	144	136	8
33,201-34,200	25	200	25	56	144	136	8
34,201-35,200	25	200	25	56	144	136	8
35,201-36,200	25	200	25	56	144	136	8
36,201-37,200	25	200	25	56	144	136	8
37,201-38,200	25	200	25	56	144	136	8
38,201-39,200	25	200	25	56	144	136	8
39,201-40,200	25	200	25	56	144	136	8

Dimensions in mm.

Cutting data see page 367 ff.

Information on special designs and other coatings on request.

RR 01 | 040327

Preferred series for through bore, expandable design with brazed cermet blades

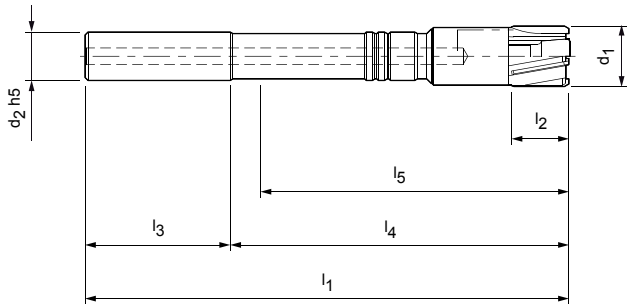

Design:

Diameter: 8,00-40,00 mm
 Cutting direction: Right-hand cutting
 Cutting material: Cermet, uncoated
 Flute direction: Left-hand fluted
 Geometry: HPC, EU spacing

Special feature:

Expandable by 0,03 mm through front-mounted screw

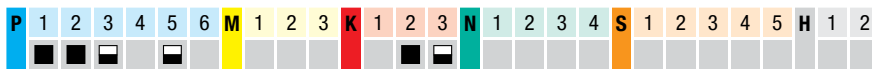

Dimensions							z	Order No.
$d_1 H7$	$d_2 h5$	l_1	l_2	l_3	l_4	l_5		
8,00	6	110	12	36	74	68	4	30109691
8,50	6	110	12	36	74	68	4	30109693
9,00	6	110	12	36	74	68	6	30109695
9,50	8	120	12	36	84	78	6	30109697
10,00	8	120	12	36	84	78	6	30109699
10,50	8	120	12	36	84	78	6	30242818
11,00	8	120	12	36	84	78	6	30109701
11,50	8	120	12	36	84	78	6	30242824
12,00	10	140	12	40	100	93	6	30109703
12,50	10	140	12	40	100	93	6	30242825
13,00	10	140	12	40	100	93	6	30109705
14,00	12	140	16	45	95	88	6	30109707
15,00	12	140	16	45	95	88	6	30109709
16,00	14	160	19	45	115	108	6	30109711
17,00	14	160	19	45	115	108	6	30109713
18,00	16	160	19	48	112	105	6	30109715
19,00	16	160	19	48	112	105	6	30109717
20,00	16	160	19	48	112	105	6	30109719
21,00	16	160	19	48	112	105	6	30109721
22,00	16	160	22	48	112	105	6	30109723
23,00	20	180	22	50	130	122	6	30109725
24,00	20	180	22	50	130	122	6	30109727
25,00	20	180	22	50	130	122	6	30109729
26,00	20	180	22	50	130	122	6	30109731
27,00	20	180	25	50	130	122	6	30109733
28,00	25	180	25	56	124	116	6	30109735
29,00	25	180	25	56	124	116	6	30109737
30,00	25	200	25	56	144	136	6	30109739
31,00	25	200	25	56	144	136	6	30109741
32,00	25	200	25	56	144	136	6	30109743
33,00	25	200	25	56	144	136	6	30109745
34,00	25	200	25	56	144	136	8	30109747
35,00	25	200	25	56	144	136	8	30109749
36,00	25	200	25	56	144	136	8	30109751
37,00	25	200	25	56	144	136	8	30109753
38,00	25	200	25	56	144	136	8	30109755
39,00	25	200	25	56	144	136	8	30109757
40,00	25	200	25	56	144	136	8	30109759

Dimensions in mm.

Cutting data see page 367 ff.

Information on special designs and other coatings on request.

RR 01 | 040327

Configurable series for through bore, expandable design with brazed cermet blades

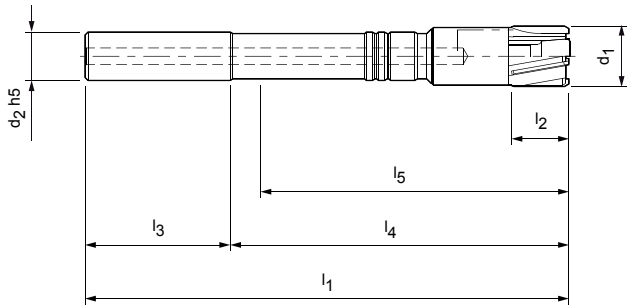

Design:

Diameter: 7,701-40,200 mm
 Cutting direction: Right-hand cutting
 Cutting material: Cermet, uncoated
 Flute direction: Left-hand fluted
 Geometry: HPC, EU spacing

Special feature:

Expandable by 0,03 mm through front-mounted screw



Dimensions							z
d_1	$d_2 h_5$	l_1	l_2	l_3	l_4	l_5	
7,701-8,200	6	110	12	36	74	68	4
8,201-8,700	6	110	12	36	74	68	4
8,701-9,200	6	110	12	36	74	68	6
9,201-9,700	8	120	12	36	84	78	6
9,701-10,200	8	120	12	36	84	78	6
10,201-10,700	8	120	12	36	84	78	6
10,701-11,200	8	120	12	36	84	78	6
11,201-11,700	8	120	12	36	84	78	6
11,701-12,200	10	140	12	40	100	93	6
12,201-12,700	10	140	12	40	100	93	6
12,701-13,200	10	140	12	40	100	93	6
13,201-14,200	12	140	16	45	95	88	6
14,201-15,200	12	140	16	45	95	88	6
15,201-16,200	14	160	19	45	115	108	6
16,201-17,200	14	160	19	45	115	108	6
17,201-18,200	16	160	19	48	112	105	6
18,201-19,200	16	160	19	48	112	105	6
19,201-20,200	16	160	19	48	112	105	6
20,201-21,200	16	160	19	48	112	105	6
21,201-22,200	16	160	22	48	112	105	6
22,201-23,200	20	180	22	50	130	122	6
23,201-24,200	20	180	22	50	130	122	6
24,201-25,200	20	180	22	50	130	122	6
25,201-26,200	20	180	22	50	130	122	6
26,201-27,200	20	180	25	50	130	122	6
27,201-28,200	25	180	25	56	124	116	6
28,201-29,200	25	180	25	56	124	116	6
29,201-30,200	25	200	25	56	144	136	6
30,201-31,200	25	200	25	56	144	136	6
31,201-32,200	25	200	25	56	144	136	6
32,201-33,200	25	200	25	56	144	136	6
33,201-34,200	25	200	25	56	144	136	8
34,201-35,200	25	200	25	56	144	136	8
35,201-36,200	25	200	25	56	144	136	8
36,201-37,200	25	200	25	56	144	136	8
37,201-38,200	25	200	25	56	144	136	8
38,201-39,200	25	200	25	56	144	136	8
39,201-40,200	25	200	25	56	144	136	8

Dimensions in mm.

Cutting data see page 367 ff.

Information on special designs and other coatings on request.

RR 01 | 040340

Preferred series for blind bore, solid cermet head

Design:

Diameter:
Cutting direction:
Cutting material:
Flute direction:
Geometry:

4,00-20,00 mm
Right-hand cutting
Cermet, uncoated
Straight fluted
HPC, EU spacing

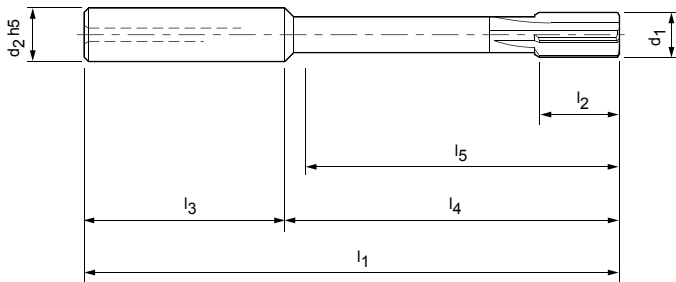

Dimensions							z	Order No.
d ₁ H7	d ₂ h5	l ₁	l ₂	l ₃	l ₄	l ₅		
4,00	10	80	12	40	40	33	4	30109761
4,50	10	80	12	40	40	33	4	30109763
5,00	12	85	12	45	40	33	4	30109765
5,50	12	85	12	45	40	33	4	30109767
6,00	12	85	12	45	40	33	4	30109769
6,50	12	105	12	45	60	53	6	30109771
7,00	12	110	16	45	65	58	6	30109773
7,50	12	110	16	45	65	58	6	30109775
8,00	12	110	16	45	65	58	6	30109777
8,50	12	120	19	45	75	68	6	30109779
9,00	12	120	19	45	75	68	6	30109781
9,50	12	120	19	45	75	68	6	30109783
10,00	12	120	19	45	75	68	6	30109785
10,50	12	120	19	45	75	68	6	30109787
11,00	12	120	19	45	75	68	6	30109789
12,00	12	120	19	45	75	68	6	30109793
13,00	16	130	19	48	82	75	6	30109795
14,00	16	130	19	48	82	75	6	30109797
15,00	16	130	19	48	82	75	6	30109799
16,00	16	130	19	48	82	75	6	30109801
17,00	16	160	22	48	112	105	6	30109803
18,00	16	160	22	48	112	105	6	30109805
19,00	16	160	22	48	112	105	6	30109807
20,00	16	160	22	48	112	105	6	30109809

Dimensions in mm.

Cutting data see page 367 ff.

Information on special designs and other coatings on request.

RR 01 | 040340

Configurable series for blind bore, solid cermet head

Design:

Diameter:
Cutting direction:
Cutting material:
Flute direction:
Geometry:

3,850-20,200 mm
Right-hand cutting
Cermet, uncoated
Straight fluted
HPC, EU spacing

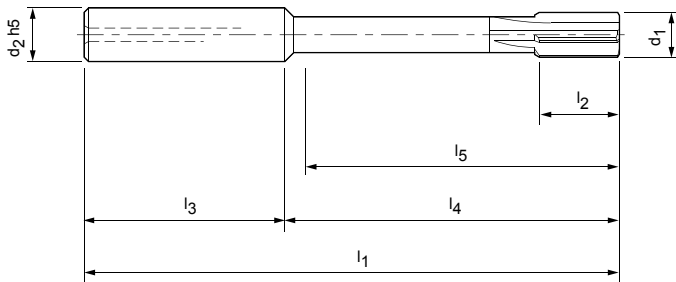

Dimensions							Z
d_1	$d_2 h_5$	l_1	l_2	l_3	l_4	l_5	
3,850-4,350	10	80	12	40	40	33	4
4,351-4,900	10	80	12	40	40	33	4
4,901-5,300	12	85	12	45	40	33	4
5,301-5,700	12	85	12	45	40	33	4
5,701-6,200	12	85	12	45	40	33	4
6,201-6,700	12	105	12	45	60	53	6
6,701-7,200	12	110	16	45	65	58	6
7,201-7,700	12	110	16	45	65	58	6
7,701-8,200	12	110	16	45	65	58	6
8,201-8,700	12	120	19	45	75	68	6
8,701-9,200	12	120	19	45	75	68	6
9,201-9,700	12	120	19	45	75	68	6
9,701-10,200	12	120	19	45	75	68	6
10,201-10,700	12	120	19	45	75	68	6
10,701-11,200	12	120	19	45	75	68	6
11,201-12,200	12	120	19	45	75	68	6
12,201-13,200	16	130	19	48	82	75	6
13,201-14,200	16	130	19	48	82	75	6
14,201-15,200	16	130	19	48	82	75	6
15,201-16,200	16	130	19	48	82	75	6
16,201-17,200	16	160	22	48	112	105	6
17,201-18,200	16	160	22	48	112	105	6
18,201-19,200	16	160	22	48	112	105	6
19,201-20,200	16	160	22	48	112	105	6

Dimensions in mm.

Cutting data see page 367 ff.

Information on special designs and other coatings on request.

RR 01 | 040341

Preferred series for blind bore, brazed cermet blades

Design:

Diameter:
Cutting direction:
Cutting material:
Flute direction:
Geometry:

21,00-40,00 mm
Right-hand cutting
Cermet, uncoated
Straight fluted
HPC, EU spacing

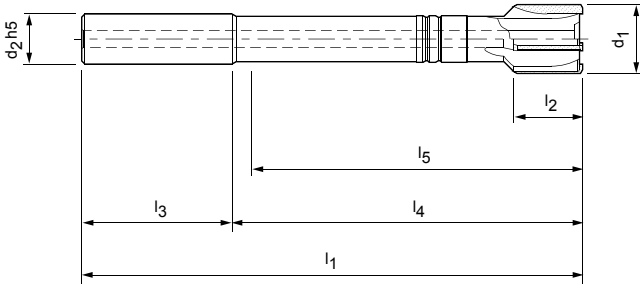

Dimensions							z	Order No.
d ₁ H7	d ₂ h5	l ₁	l ₂	l ₃	l ₄	l ₅		
21,00	16	160	19	48	112	102	6	30109811
22,00	16	160	22	48	112	102	6	30109813
23,00	20	180	22	50	130	120	6	30109815
24,00	20	180	22	50	130	120	6	30109817
25,00	20	180	22	50	130	120	6	30109819
26,00	20	180	22	50	130	120	6	30109821
27,00	20	180	25	50	130	120	6	30109823
28,00	25	180	25	56	124	114	6	30109825
29,00	25	180	25	56	124	114	6	30109827
30,00	25	200	25	56	144	134	6	30109829
31,00	25	200	25	56	144	134	6	30109831
32,00	25	200	25	56	144	134	6	30109833
33,00	25	200	25	56	144	134	6	30109835
34,00	25	200	25	56	144	134	6	30109837
35,00	25	200	25	56	144	134	8	30109839
36,00	25	200	25	56	144	134	8	30109841
37,00	25	200	25	56	144	134	8	30109843
38,00	25	200	25	56	144	134	8	30109845
39,00	25	200	25	56	144	134	8	30109847
40,00	25	200	25	56	144	134	8	30109849

Dimensions in mm.

Cutting data see page 367 ff.

Information on special designs and other coatings on request.

RR 01 | 040341

Configurable series for blind bore, brazed cermet blades

Design:

Diameter:
Cutting direction:
Cutting material:
Flute direction:
Geometry:

20,201-40,200 mm
Right-hand cutting
Cermet, uncoated
Straight fluted
HPC, EU spacing

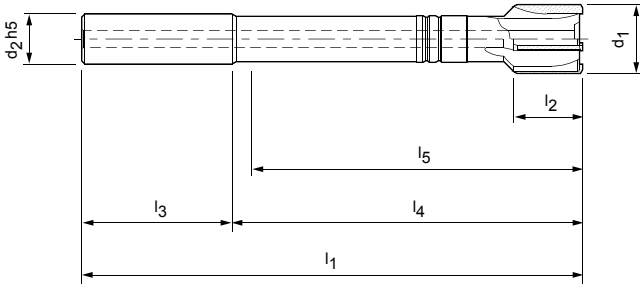

Dimensions							Z
d_1	$d_2 h_5$	l_1	l_2	l_3	l_4	l_5	
20,201-21,200	16	160	19	48	112	102	6
21,201-22,200	16	160	22	48	112	102	6
22,201-23,200	20	180	22	50	130	120	6
23,201-24,200	20	180	22	50	130	120	6
24,201-25,200	20	180	22	50	130	120	6
25,201-26,200	20	180	22	50	130	120	6
26,201-27,200	20	180	25	50	130	120	6
27,201-28,200	25	180	25	56	124	114	6
28,201-29,200	25	180	25	56	124	114	6
29,201-30,200	25	200	25	56	144	134	6
30,201-31,200	25	200	25	56	144	134	6
31,201-32,200	25	200	25	56	144	134	6
32,201-33,200	25	200	25	56	144	134	6
33,201-34,200	25	200	25	56	144	134	6
34,201-35,200	25	200	25	56	144	134	8
35,201-36,200	25	200	25	56	144	134	8
36,201-37,200	25	200	25	56	144	134	8
37,201-38,200	25	200	25	56	144	134	8
38,201-39,200	25	200	25	56	144	134	8
39,201-40,200	25	200	25	56	144	134	8

Dimensions in mm.

Cutting data see page 367 ff.

Information on special designs and other coatings on request.





VR REAMERS

Introduction

Product overview	112
------------------	-----

Series for through bore

VR 01, solid carbide, BSP coated	040390	114
VR 01, carbide, uncoated	040370	116
VR 01, carbide, BSP coated	040382	118
VR 01, cermet, uncoated	040372	120
VR 01, CBN, for machining hardened materials	040376	122
VR 01, CBN, for machining cast iron	040378	124
VR 01, PCD blades	040374	126
Overview configurable series		128

PRODUCT OVERVIEW

VR 01 - multi-tooth reamers

The most important measure for the performance of multi-bladed reamers is the number of cutting edges. This is limited by the diameter of the tool and by the space required for the chip spaces. Whereas to date, for example, there was only space for eight blades on a 40-mm diameter, the VR 01 now has 18 blades on the same sized tool. Depending on the machining tasks and the material, different cutting materials are used.

The number of blades and the right choice of cutting material enable machining speeds to be achieved that were previously impossible during reaming. In addition, due to their support on the bore walls, the large number of blades ensures an outstanding circularity of the reamed bore.



Tool features in detail

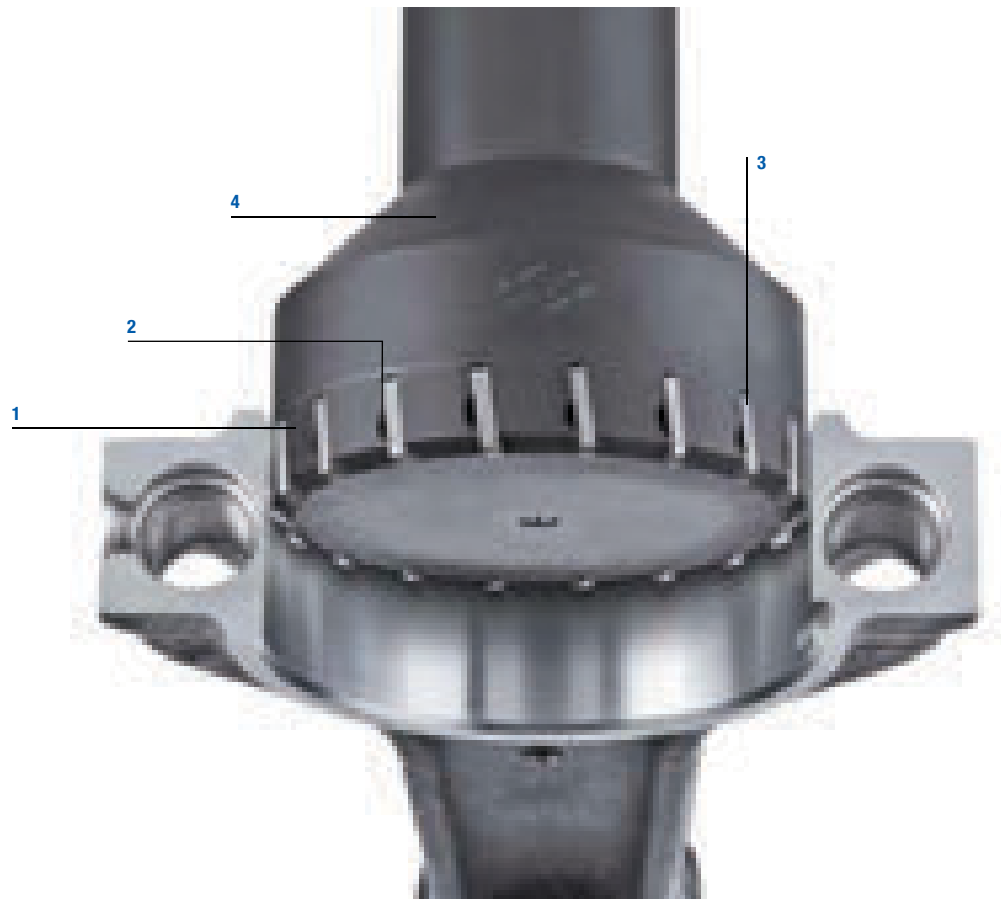

- 1 No chip spaces**
Maximum number of cutting edges
- 2 Internal coolant supply**
Exit directly at the cutting edge
- 3 High strength blade attachment**
Maximum performance
- 4 Wear-resistant tool body**
Cost-effective re-tipping



VR 01 | 040390
Solid carbide design



Multi-tooth high-performance reamer straight fluted made of solid carbide.

Ø range: 6.00-12.00 mm



P

VR 01 | 040370-040382
Tipped design



Multi-tooth high-performance reamer with brazed blades left-hand spiral fluted.

Ø range: 10.00-40.00 mm



P K N H

VR 01 | 040390

Preferred series for through bore, internal coolant supply

Design:

Diameter:
Cutting direction:
Cutting material:

6,00-12,00 mm
Right-hand cutting
Solid carbide,
BSP coated

Flute direction:
Geometry:

Straight fluted
HPC, EU spacing

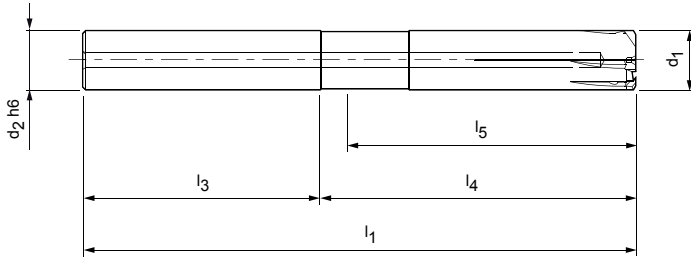

Dimensions						z	Order No.
$d_1\ H7$	$d_2\ h6$	l_1	l_3	l_4	l_5		
6,00	6	75	36	39	31	6	30308418
6,50	8	100	36	64	56	8	30311639
7,00	8	100	36	64	56	8	30311643
7,50	8	100	36	64	56	8	30311644
8,00	8	100	36	64	56	8	30308420
8,50	10	100	40	60	52	8	30311645
9,00	10	100	40	60	52	8	30311646
9,50	10	120	40	80	72	8	30311647
10,00	10	120	40	80	72	8	30308424
10,50	12	120	45	75	67	10	30311649
11,00	12	120	45	75	67	10	30311650
11,50	12	120	45	75	67	10	30311652
12,00	12	120	45	75	67	10	30308427

Dimensions in mm.
Cutting data see page 367 ff.
Information on special designs and other coatings on request.

VR 01 | 040390

Configurable series for through bore, internal coolant supply

Design:

Diameter: 5,700-12,200 mm
 Cutting direction: Right-hand cutting
 Cutting material: Solid carbide, BSP coated
 Flute direction: Straight fluted
 Geometry: HPC, EU spacing

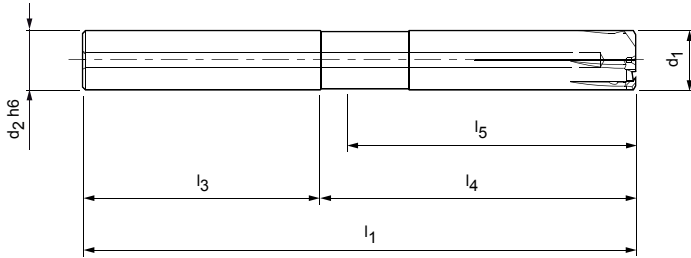

Dimensions						z
d_1	$d_2 h_6$	l_1	l_3	l_4	l_5	
5,700-6,200	6	75	36	39	31	6
6,201-6,700	8	100	36	64	56	8
6,701-7,200	8	100	36	64	56	8
7,201-7,700	8	100	36	64	56	8
7,701-8,200	8	100	36	64	56	8
8,201-8,700	10	100	40	60	52	8
8,701-9,200	10	100	40	60	52	8
9,201-9,700	10	120	40	80	72	8
9,701-10,200	10	120	40	80	72	8
10,201-10,700	12	120	45	75	67	10
10,701-11,200	12	120	45	75	67	10
11,201-11,700	12	120	45	75	67	10
11,701-12,200	12	120	45	75	67	10

Dimensions in mm.
 Cutting data see page 367 ff.
 Information on special designs and other coatings on request.

VR 01 | 040370

Preferred series for through bore, with brazed blades, internal coolant supply

Design:

Diameter:
Cutting direction:
Cutting material:
Flute direction:
Geometry:

10,00-40,00 mm
Right-hand cutting
Carbide, uncoated
Left-hand fluted
HPC, EU spacing

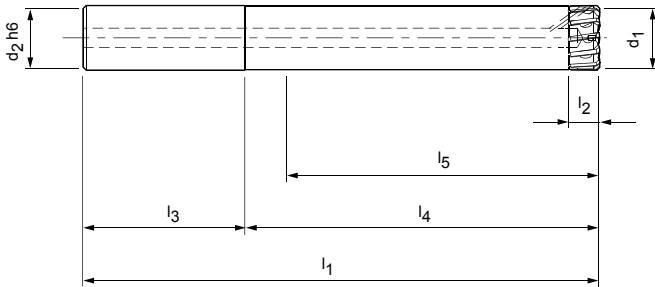

Dimensions							z	Order No.
d_1 H7	d_2 h6	l_1	l_2	l_3	l_4	l_5		
10,00	12	120	9	45	75	67	6	30611604
10,50	12	120	9	45	75	67	6	30611605
11,00	12	120	9	45	75	67	6	30611606
11,50	12	120	9	45	75	67	6	30611607
12,00	12	120	9	45	75	67	8	30252427
12,50	16	130	9	48	82	74	8	30611608
13,00	16	130	9	48	82	74	8	30611609
13,50	16	130	9	48	82	74	8	30611610
14,00	16	130	9	48	82	74	10	30377395
14,50	16	130	9	48	82	74	10	30611611
15,00	16	130	9	48	82	74	10	30587598
15,50	16	130	9	48	82	74	10	30611612
16,00	16	130	9	48	82	74	10	30611613
16,50	20	160	9	50	110	102	10	30611614
17,00	20	160	9	50	110	102	10	30611615
17,50	20	160	9	50	110	102	10	30611616
18,00	20	160	9	50	110	102	12	30611617
18,50	20	160	9	50	110	102	12	30611618
19,00	20	160	9	50	110	102	12	30611619
19,50	20	160	9	50	110	102	12	30611620
20,00	20	160	9	50	110	102	12	30611621
20,50	20	160	9	50	110	102	12	30611622
21,00	20	160	9	50	110	102	12	30611623
21,50	20	160	9	50	110	102	12	30611624
22,00	20	160	9	50	110	102	14	30611625
22,50	20	180	9	50	130	122	14	30611626
23,00	20	180	9	50	130	122	14	30611627
23,50	20	180	9	50	130	122	14	30611628
24,00	20	180	9	50	130	122	14	30611629
24,50	20	180	9	50	130	122	14	30611630
25,00	20	180	9	50	130	122	16	30611631
25,50	20	180	9	50	130	122	16	30611632
26,00	20	180	9	50	130	122	16	30611633
26,50	20	180	9	50	130	122	16	30611634
27,00	20	180	9	50	130	122	16	30611635
27,50	20	180	9	50	130	122	16	30611636
28,00	25	180	9	56	124	116	16	30611637
28,50	25	180	9	56	124	116	16	30611638
29,00	25	180	9	56	124	116	16	30611639

VR 01 | 040370, preferred series for through bore with brazed blades

Dimensions							z	Order No.
d ₁ H7	d ₂ h6	l ₁	l ₂	l ₃	l ₄	l ₅		
29,50	25	200	9	56	144	136	16	30611640
30,00	25	200	9	56	144	136	16	30611641
30,50	25	200	9	56	144	136	16	30611642
31,00	25	200	9	56	144	136	16	30611643
31,50	25	200	9	56	144	136	16	30611644
32,00	25	200	9	56	144	136	18	30611645
32,50	25	200	9	56	144	136	18	30611646
33,00	25	200	9	56	144	136	18	30611647
33,50	25	200	9	56	144	136	18	30611649
34,00	25	200	9	56	144	136	18	30611650
34,50	25	200	9	56	144	136	18	30611651
35,00	25	200	9	56	144	136	18	30611652
35,50	25	200	9	56	144	136	18	30611653
36,00	32	200	9	60	140	132	18	30611654
36,50	32	200	9	60	140	132	18	30611655
37,00	32	200	9	60	140	132	18	30611656
37,50	32	200	9	60	140	132	18	30611657
38,00	32	200	9	60	140	132	18	30611658
38,50	32	200	9	60	140	132	18	30611659
39,00	32	200	9	60	140	132	18	30611660
39,50	32	200	9	60	140	132	18	30611661
40,00	32	200	9	60	140	132	18	30611662

Dimensions in mm.

Cutting data see page 367 ff.

Information on special designs and other coatings on request.

Intermediate diameters and special tolerances can be ordered by the overview pages for configurable series on Page 128.

VR 01 | 040382

Preferred series for through bore, with brazed blades, internal coolant supply

Design:

Diameter:
Cutting direction:
Cutting material:
Flute direction:
Geometry:

10,00-40,00 mm
Right-hand cutting
Carbide, BSP coated
Left-hand fluted
HPC, EU spacing

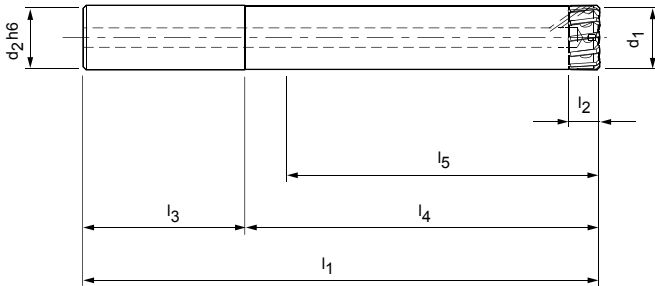

Dimensions							z	Order No.
d_1 H7	d_2 h6	l_1	l_2	l_3	l_4	l_5		
10,00	12	120	9	45	75	67	6	30308439
10,50	12	120	9	45	75	67	6	30611663
11,00	12	120	9	45	75	67	6	30611664
11,50	12	120	9	45	75	67	6	30611665
12,00	12	120	9	45	75	67	8	30308440
12,50	16	130	9	48	82	74	8	30611666
13,00	16	130	9	48	82	74	8	30611667
13,50	16	130	9	48	82	74	8	30611668
14,00	16	130	9	48	82	74	10	30308442
14,50	16	130	9	48	82	74	10	30611669
15,00	16	130	9	48	82	74	10	30611670
15,50	16	130	9	48	82	74	10	30611671
16,00	16	130	9	48	82	74	10	30611672
16,50	20	160	9	50	110	102	10	30611673
17,00	20	160	9	50	110	102	10	30611674
17,50	20	160	9	50	110	102	10	30611675
18,00	20	160	9	50	110	102	12	30611676
18,50	20	160	9	50	110	102	12	30611677
19,00	20	160	9	50	110	102	12	30611678
19,50	20	160	9	50	110	102	12	30611679
20,00	20	160	9	50	110	102	12	30611680
20,50	20	160	9	50	110	102	12	30611681
21,00	20	160	9	50	110	102	12	30611682
21,50	20	160	9	50	110	102	12	30611683
22,00	20	160	9	50	110	102	14	30611684
22,50	20	180	9	50	130	122	14	30611685
23,00	20	180	9	50	130	122	14	30611686
23,50	20	180	9	50	130	122	14	30611687
24,00	20	180	9	50	130	122	14	30611688
24,50	20	180	9	50	130	122	14	30611689
25,00	20	180	9	50	130	122	16	30611690
25,50	20	180	9	50	130	122	16	30611691
26,00	20	180	9	50	130	122	16	30611692
26,50	20	180	9	50	130	122	16	30611693
27,00	20	180	9	50	130	122	16	30611694
27,50	20	180	9	50	130	122	16	30611695
28,00	25	180	9	56	124	116	16	30611696
28,50	25	180	9	56	124	116	16	30611697
29,00	25	180	9	56	124	116	16	30611698

VR 01 | 040382, preferred series for through bore with brazed blades

Dimensions							z	Order No.
d ₁ H7	d ₂ h6	l ₁	l ₂	l ₃	l ₄	l ₅		
29,50	25	200	9	56	144	136	16	30611699
30,00	25	200	9	56	144	136	16	30611700
30,50	25	200	9	56	144	136	16	30611701
31,00	25	200	9	56	144	136	16	30611702
31,50	25	200	9	56	144	136	16	30611703
32,00	25	200	9	56	144	136	18	30611704
32,50	25	200	9	56	144	136	18	30611705
33,00	25	200	9	56	144	136	18	30611706
33,50	25	200	9	56	144	136	18	30611707
34,00	25	200	9	56	144	136	18	30611708
34,50	25	200	9	56	144	136	18	30611709
35,00	25	200	9	56	144	136	18	30611710
35,50	25	200	9	56	144	136	18	30611711
36,00	32	200	9	60	140	132	18	30611712
36,50	32	200	9	60	140	132	18	30611713
37,00	32	200	9	60	140	132	18	30611714
37,50	32	200	9	60	140	132	18	30611715
38,00	32	200	9	60	140	132	18	30611716
38,50	32	200	9	60	140	132	18	30611717
39,00	32	200	9	60	140	132	18	30611718
39,50	32	200	9	60	140	132	18	30611719
40,00	32	200	9	60	140	132	18	30611720

Dimensions in mm.

Cutting data see page 367 ff.

Information on special designs and other coatings on request.

Intermediate diameters and special tolerances can be ordered by the overview pages for configurable series on Page 128.

VR 01 | 040372

Preferred series for through bore, with brazed blades, internal coolant supply

Design:

Diameter:
Cutting direction:
Cutting material:
Flute direction:
Geometry:

10,00-40,00 mm
Right-hand cutting
Cermet, uncoated
Left-hand fluted
HPC, EU spacing

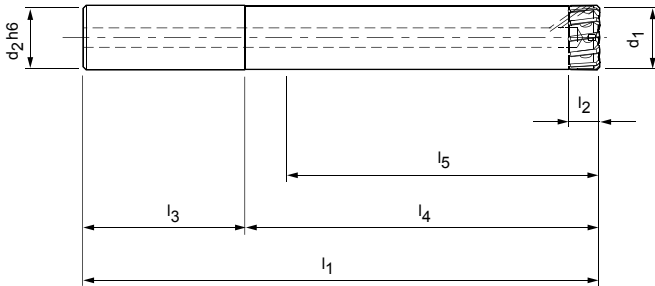

Dimensions							z	Order No.
d_1 H7	d_2 h6	l_1	l_2	l_3	l_4	l_5		
10,00	12	120	9	45	75	67	6	30611721
10,50	12	120	9	45	75	67	6	30611722
11,00	12	120	9	45	75	67	6	30611723
11,50	12	120	9	45	75	67	6	30611724
12,00	12	120	9	45	75	67	8	30259464
12,50	16	130	9	48	82	74	8	30438339
13,00	16	130	9	48	82	74	8	30611725
13,50	16	130	9	48	82	74	8	30611726
14,00	16	130	9	48	82	74	10	30611727
14,50	16	130	9	48	82	74	10	30611728
15,00	16	130	9	48	82	74	10	30611729
15,50	16	130	9	48	82	74	10	30611730
16,00	16	130	9	48	82	74	10	30611731
16,50	20	160	9	50	110	102	10	30611732
17,00	20	160	9	50	110	102	10	30611733
17,50	20	160	9	50	110	102	10	30611734
18,00	20	160	9	50	110	102	12	30277002
18,50	20	160	9	50	110	102	12	30611735
19,00	20	160	9	50	110	102	12	30611736
19,50	20	160	9	50	110	102	12	30611737
20,00	20	160	9	50	110	102	12	30276094
20,50	20	160	9	50	110	102	12	30611738
21,00	20	160	9	50	110	102	12	30611739
21,50	20	160	9	50	110	102	12	30611740
22,00	20	160	9	50	110	102	14	30267795
22,50	20	180	9	50	130	122	14	30611741
23,00	20	180	9	50	130	122	14	30611742
23,50	20	180	9	50	130	122	14	30611743
24,00	20	180	9	50	130	122	14	30611744
24,50	20	180	9	50	130	122	14	30611745
25,00	20	180	9	50	130	122	16	30611746
25,50	20	180	9	50	130	122	16	30611747
26,00	20	180	9	50	130	122	16	30611748
26,50	20	180	9	50	130	122	16	30611749
27,00	20	180	9	50	130	122	16	30611750
27,50	20	180	9	50	130	122	16	30611751
28,00	25	180	9	56	124	116	16	30276093
28,50	25	180	9	56	124	116	16	30611752
29,00	25	180	9	56	124	116	16	30611753

VR 01 | 040372, preferred series for through bore with brazed blades

Dimensions							z	Order No.
d ₁ H7	d ₂ h6	l ₁	l ₂	l ₃	l ₄	l ₅		
29,50	25	200	9	56	144	136	16	30611754
30,00	25	200	9	56	144	136	16	30611755
30,50	25	200	9	56	144	136	16	30611756
31,00	25	200	9	56	144	136	16	30611757
31,50	25	200	9	56	144	136	16	30611758
32,00	25	200	9	56	144	136	18	30611759
32,50	25	200	9	56	144	136	18	30611760
33,00	25	200	9	56	144	136	18	30611761
33,50	25	200	9	56	144	136	18	30611762
34,00	25	200	9	56	144	136	18	30611763
34,50	25	200	9	56	144	136	18	30611764
35,00	25	200	9	56	144	136	18	30611765
35,50	25	200	9	56	144	136	18	30611766
36,00	32	200	9	60	140	132	18	30611767
36,50	32	200	9	60	140	132	18	30611768
37,00	32	200	9	60	140	132	18	30611769
37,50	32	200	9	60	140	132	18	30611770
38,00	32	200	9	60	140	132	18	30611771
38,50	32	200	9	60	140	132	18	30611772
39,00	32	200	9	60	140	132	18	30287266
39,50	32	200	9	60	140	132	18	30611773
40,00	32	200	9	60	140	132	18	30611774

Dimensions in mm.

Cutting data see page 367 ff.

Information on special designs and other coatings on request.

Intermediate diameters and special tolerances can be ordered by the overview pages for configurable series on Page 128.

VR 01 | 040376

Preferred series for through bore, with brazed blades, internal coolant supply

Design:

Diameter:
Cutting direction:
Cutting material:
Flute direction:
Geometry:

10,00-40,00 mm
Right-hand cutting
CBN blades
Left-hand fluted
HPC, EU spacing

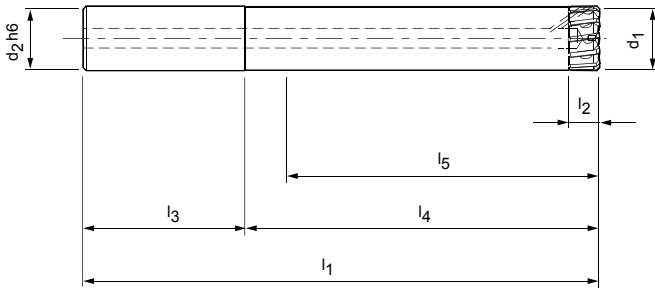

Dimensions							z	Order No.
$d_1 H7$	$d_2 h6$	l_1	l_2	l_3	l_4	l_5		
10,00	12	120	9	45	75	67	6	30611775
10,50	12	120	9	45	75	67	6	30611776
11,00	12	120	9	45	75	67	6	30611777
11,50	12	120	9	45	75	67	6	30611778
12,00	12	120	9	45	75	67	8	30611779
12,50	16	130	9	48	82	74	8	30611780
13,00	16	130	9	48	82	74	8	30611781
13,50	16	130	9	48	82	74	8	30611782
14,00	16	130	9	48	82	74	10	30611783
14,50	16	130	9	48	82	74	10	30611784
15,00	16	130	9	48	82	74	10	30611785
15,50	16	130	9	48	82	74	10	30611786
16,00	16	130	9	48	82	74	10	30611787
16,50	20	160	9	50	110	102	10	30611788
17,00	20	160	9	50	110	102	10	30611789
17,50	20	160	9	50	110	102	10	30611790
18,00	20	160	9	50	110	102	12	30611791
18,50	20	160	9	50	110	102	12	30611792
19,00	20	160	9	50	110	102	12	30611793
19,50	20	160	9	50	110	102	12	30611794
20,00	20	160	9	50	110	102	12	30611795
20,50	20	160	9	50	110	102	12	30611796
21,00	20	160	9	50	110	102	12	30611797
21,50	20	160	9	50	110	102	12	30611798
22,00	20	160	9	50	110	102	14	30611799
22,50	20	180	9	50	130	122	14	30611800
23,00	20	180	9	50	130	122	14	30611801
23,50	20	180	9	50	130	122	14	30611802
24,00	20	180	9	50	130	122	14	30611803
24,50	20	180	9	50	130	122	14	30611804
25,00	20	180	9	50	130	122	16	30611805
25,50	20	180	9	50	130	122	16	30611806
26,00	20	180	9	50	130	122	16	30611807
26,50	20	180	9	50	130	122	16	30611808
27,00	20	180	9	50	130	122	16	30611809
27,50	20	180	9	50	130	122	16	30611810
28,00	25	180	9	56	124	116	16	30611811
28,50	25	180	9	56	124	116	16	30611812
29,00	25	180	9	56	124	116	16	30611813

VR 01 | 040376, preferred series for through bore with brazed blades

Dimensions							z	Order No.
d ₁ H7	d ₂ h6	l ₁	l ₂	l ₃	l ₄	l ₅		
29,50	25	200	9	56	144	136	16	30611814
30,00	25	200	9	56	144	136	16	30611815
30,50	25	200	9	56	144	136	16	30611816
31,00	25	200	9	56	144	136	16	30611817
31,50	25	200	9	56	144	136	16	30611818
32,00	25	200	9	56	144	136	18	30611819
32,50	25	200	9	56	144	136	18	30611820
33,00	25	200	9	56	144	136	18	30611821
33,50	25	200	9	56	144	136	18	30611822
34,00	25	200	9	56	144	136	18	30611823
34,50	25	200	9	56	144	136	18	30611824
35,00	25	200	9	56	144	136	18	30611825
35,50	25	200	9	56	144	136	18	30611826
36,00	32	200	9	60	140	132	18	30611827
36,50	32	200	9	60	140	132	18	30611828
37,00	32	200	9	60	140	132	18	30611829
37,50	32	200	9	60	140	132	18	30611830
38,00	32	200	9	60	140	132	18	30611831
38,50	32	200	9	60	140	132	18	30611832
39,00	32	200	9	60	140	132	18	30611833
39,50	32	200	9	60	140	132	18	30611834
40,00	32	200	9	60	140	132	18	30611835

Dimensions in mm.

Cutting data see page 367 ff.

Information on special designs and other coatings on request.

Intermediate diameters and special tolerances can be ordered by the overview pages for configurable series on Page 128.

VR 01 | 040378

Preferred series for through bore, with brazed blades, internal coolant supply

Design:

Diameter:
Cutting direction:
Cutting material:
Flute direction:
Geometry:

10,00-40,00 mm
Right-hand cutting
CBN blades
Left-hand fluted
HPC, EU spacing

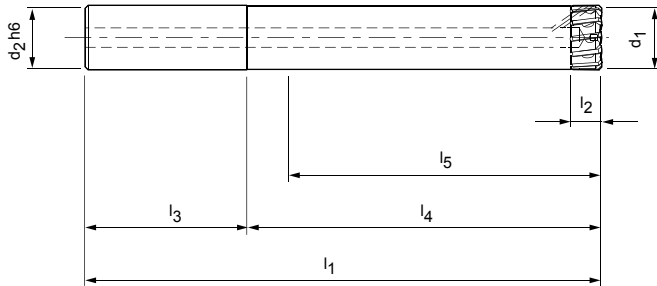

P 1 2 3 4 5 6 M 1 2 3 K 1 2 3 N 1 2 3 4 S 1 2 3 4 5 H 1.1 1.2 2



Dimensions							z	Order No.
d_1 H7	d_2 h6	l_1	l_2	l_3	l_4	l_5		
10,00	12	120	9	45	75	67	6	30277654
10,50	12	120	9	45	75	67	6	30611836
11,00	12	120	9	45	75	67	6	30611837
11,50	12	120	9	45	75	67	6	30611838
12,00	12	120	9	45	75	67	8	30611839
12,50	16	130	9	48	82	74	8	30611840
13,00	16	130	9	48	82	74	8	30611841
13,50	16	130	9	48	82	74	8	30611842
14,00	16	130	9	48	82	74	10	30611843
14,50	16	130	9	48	82	74	10	30611844
15,00	16	130	9	48	82	74	10	30611845
15,50	16	130	9	48	82	74	10	30611846
16,00	16	130	9	48	82	74	10	30611847
16,50	20	160	9	50	110	102	10	30611848
17,00	20	160	9	50	110	102	10	30611849
17,50	20	160	9	50	110	102	10	30611850
18,00	20	160	9	50	110	102	12	30611851
18,50	20	160	9	50	110	102	12	30611852
19,00	20	160	9	50	110	102	12	30611853
19,50	20	160	9	50	110	102	12	30611854
20,00	20	160	9	50	110	102	12	30611855
20,50	20	160	9	50	110	102	12	30611856
21,00	20	160	9	50	110	102	12	30611857
21,50	20	160	9	50	110	102	12	30611858
22,00	20	160	9	50	110	102	14	30611859
22,50	20	180	9	50	130	122	14	30611860
23,00	20	180	9	50	130	122	14	30611861
23,50	20	180	9	50	130	122	14	30611862
24,00	20	180	9	50	130	122	14	30611863
24,50	20	180	9	50	130	122	14	30611864
25,00	20	180	9	50	130	122	16	30611865
25,50	20	180	9	50	130	122	16	30611866
26,00	20	180	9	50	130	122	16	30611867
26,50	20	180	9	50	130	122	16	30611868
27,00	20	180	9	50	130	122	16	30611869
27,50	20	180	9	50	130	122	16	30611870
28,00	25	180	9	56	124	116	16	30611871
28,50	25	180	9	56	124	116	16	30611872
29,00	25	180	9	56	124	116	16	30611873

VR 01 | 040378, preferred series for through bore with brazed blades

Dimensions							z	Order No.
d ₁ H7	d ₂ h6	l ₁	l ₂	l ₃	l ₄	l ₅		
29,50	25	200	9	56	144	136	16	30611874
30,00	25	200	9	56	144	136	16	30611875
30,50	25	200	9	56	144	136	16	30611876
31,00	25	200	9	56	144	136	16	30611877
31,50	25	200	9	56	144	136	16	30611878
32,00	25	200	9	56	144	136	18	30611879
32,50	25	200	9	56	144	136	18	30611880
33,00	25	200	9	56	144	136	18	30611881
33,50	25	200	9	56	144	136	18	30611882
34,00	25	200	9	56	144	136	18	30611883
34,50	25	200	9	56	144	136	18	30611884
35,00	25	200	9	56	144	136	18	30611885
35,50	25	200	9	56	144	136	18	30611886
36,00	32	200	9	60	140	132	18	30611887
36,50	32	200	9	60	140	132	18	30611888
37,00	32	200	9	60	140	132	18	30611889
37,50	32	200	9	60	140	132	18	30611890
38,00	32	200	9	60	140	132	18	30611891
38,50	32	200	9	60	140	132	18	30611892
39,00	32	200	9	60	140	132	18	30611893
39,50	32	200	9	60	140	132	18	30611894
40,00	32	200	9	60	140	132	18	30611895

Dimensions in mm.

Cutting data see page 367 ff.

Information on special designs and other coatings on request.

Intermediate diameters and special tolerances can be ordered by the overview pages for configurable series on Page 128.

VR 01 | 040374

Preferred series for through bore, with brazed blades, internal coolant supply

Design:

Diameter:
Cutting direction:
Cutting material:
Flute direction:
Geometry:

10,00-40,00 mm
Right-hand cutting
PCD blades
Left-hand fluted
HPC, EU spacing

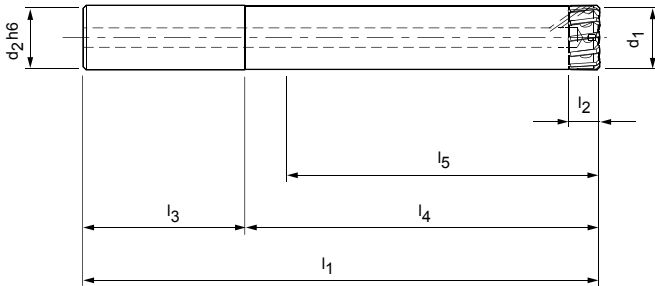

Dimensions							z	Order No.
d ₁ H7	d ₂ h6	l ₁	l ₂	l ₃	l ₄	l ₅		
10,00	12	120	9	45	75	67	6	30611896
10,50	12	120	9	45	75	67	6	30611897
11,00	12	120	9	45	75	67	6	30611898
11,50	12	120	9	45	75	67	6	30611899
12,00	12	120	9	45	75	67	8	30271606
12,50	16	130	9	48	82	74	8	30611900
13,00	16	130	9	48	82	74	8	30611901
13,50	16	130	9	48	82	74	8	30611902
14,00	16	130	9	48	82	74	10	30611903
14,50	16	130	9	48	82	74	10	30611904
15,00	16	130	9	48	82	74	10	30611905
15,50	16	130	9	48	82	74	10	30611906
16,00	16	130	9	48	82	74	10	30359823
16,50	20	160	9	50	110	102	10	30611907
17,00	20	160	9	50	110	102	10	30611908
17,50	20	160	9	50	110	102	10	30611909
18,00	20	160	9	50	110	102	12	30611910
18,50	20	160	9	50	110	102	12	30611911
19,00	20	160	9	50	110	102	12	30611912
19,50	20	160	9	50	110	102	12	30611913
20,00	20	160	9	50	110	102	12	30611914
20,50	20	160	9	50	110	102	12	30611915
21,00	20	160	9	50	110	102	12	30611916
21,50	20	160	9	50	110	102	12	30611917
22,00	20	160	9	50	110	102	14	30611918
22,50	20	180	9	50	130	122	14	30611919
23,00	20	180	9	50	130	122	14	30611920
23,50	20	180	9	50	130	122	14	30611921
24,00	20	180	9	50	130	122	14	30611922
24,50	20	180	9	50	130	122	14	30611923
25,00	20	180	9	50	130	122	16	30611924
25,50	20	180	9	50	130	122	16	30611925
26,00	20	180	9	50	130	122	16	30611926
26,50	20	180	9	50	130	122	16	30611927
27,00	20	180	9	50	130	122	16	30611928
27,50	20	180	9	50	130	122	16	30611929
28,00	25	180	9	56	124	116	16	30611930
28,50	25	180	9	56	124	116	16	30611931
29,00	25	180	9	56	124	116	16	30611932

VR 01 | 040374, preferred series for through bore with brazed blades

Dimensions							z	Order No.
d ₁ H7	d ₂ h6	l ₁	l ₂	l ₃	l ₄	l ₅		
29,50	25	200	9	56	144	136	16	30611933
30,00	25	200	9	56	144	136	16	30611934
30,50	25	200	9	56	144	136	16	30611935
31,00	25	200	9	56	144	136	16	30611936
31,50	25	200	9	56	144	136	16	30611937
32,00	25	200	9	56	144	136	18	30611938
32,50	25	200	9	56	144	136	18	30611939
33,00	25	200	9	56	144	136	18	30611940
33,50	25	200	9	56	144	136	18	30611941
34,00	25	200	9	56	144	136	18	30611942
34,50	25	200	9	56	144	136	18	30611943
35,00	25	200	9	56	144	136	18	30611944
35,50	25	200	9	56	144	136	18	30611945
36,00	32	200	9	60	140	132	18	30611946
36,50	32	200	9	60	140	132	18	30611947
37,00	32	200	9	60	140	132	18	30611948
37,50	32	200	9	60	140	132	18	30611949
38,00	32	200	9	60	140	132	18	30611950
38,50	32	200	9	60	140	132	18	30611951
39,00	32	200	9	60	140	132	18	30611952
39,50	32	200	9	60	140	132	18	30611953
40,00	32	200	9	60	140	132	18	30611954

Dimensions in mm.

Cutting data see page 367 ff.

Information on special designs and other coatings on request.

Intermediate diameters and special tolerances can be ordered by the overview pages for configurable series on Page 128.

VR 01 overview

Configurable series for through bore, with brazed blades, internal coolant supply

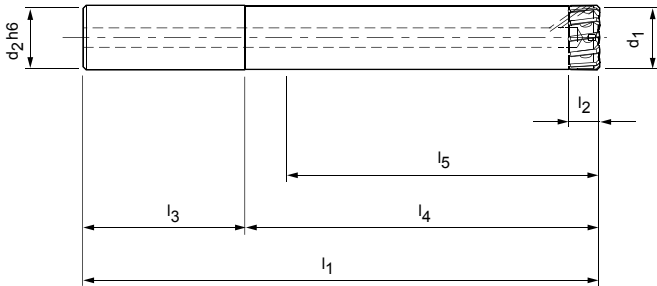

Design:

Diameter:
Cutting direction:
Cutting material:
Flute direction:
Geometry:

040370

9,760-40,250 mm
Right-hand cutting
Carbide, uncoated
Left-hand fluted
HPC, EU spacing

	P	1	2	3	4	5	6	M	1	2	3	K	1	2	3	N	1	2	3	4	S	1	2	3	4	5	H	1.1	1.2	2
040370																														
040382		■	■	■	■	■	■						■	■	■															
040372		■	■	■	■	■	■																							
040376													■																	
040378																												■	■	
040374																														



Dimensions							z
d ₁	d ₂ h6	l ₁	l ₂	l ₃	l ₄	l ₅	
9,760-10,250	12	120	9	45	75	67	6
10,251-10,750	12	120	9	45	75	67	6
10,751-11,250	12	120	9	45	75	67	6
11,251-11,750	12	120	9	45	75	67	6
11,751-12,250	12	120	9	45	75	67	8
12,251-12,750	16	130	9	48	82	74	8
12,751-13,250	16	130	9	48	82	74	8
13,251-13,750	16	130	9	48	82	74	8
13,751-14,250	16	130	9	48	82	74	10
14,251-14,750	16	130	9	48	82	74	10
14,751-15,250	16	130	9	48	82	74	10
15,251-15,750	16	130	9	48	82	74	10
15,751-16,250	16	130	9	48	82	74	10
16,251-16,750	20	160	9	50	110	102	10
16,751-17,250	20	160	9	50	110	102	10
17,251-17,750	20	160	9	50	110	102	10
17,751-18,250	20	160	9	50	110	102	12
18,251-18,750	20	160	9	50	110	102	12
18,751-19,250	20	160	9	50	110	102	12
19,251-19,750	20	160	9	50	110	102	12
19,751-20,250	20	160	9	50	110	102	12

Continued on next page.

Order example:

1. BECK product code

0 4 0 3 7 8

BECK product code

2. Diameter

1 2 . 2 6 0

Bore diameter

3. Tolerance

H 7

IT or tolerance in µm

-

Hyphen

040382

9,760-40,250 mm
Right-hand cutting
Carbide, BSP coated
Left-hand fluted
HPC, EU spacing

040372

9,760-40,250 mm
Right-hand cutting
Cermet, uncoated
Left-hand fluted
HPC, EU spacing

040376

9,760-40,250 mm
Right-hand cutting
CBN blades
Left-hand fluted
HPC, EU spacing

040378

9,760-40,250 mm
Right-hand cutting
CBN blades
Left-hand fluted
HPC, EU spacing

040374

9,760-40,250 mm
Right-hand cutting
PCD blades
Left-hand fluted
HPC, EU spacing

Dimensions							z
d ₁	d ₂ h6	l ₁	l ₂	l ₃	l ₄	l ₅	
20,251-20,750	20	160	9	50	110	102	12
20,751-21,250	20	160	9	50	110	102	12
21,251-21,750	20	160	9	50	110	102	12
21,751-22,250	20	160	9	50	110	102	14
22,251-22,750	20	180	9	50	130	122	14
22,751-23,250	20	180	9	50	130	122	14
23,251-23,750	20	180	9	50	130	122	14
23,751-24,250	20	180	9	50	130	122	14
24,251-24,750	20	180	9	50	130	122	14
24,751-25,250	20	180	9	50	130	122	16
25,251-25,750	20	180	9	50	130	122	16
25,751-26,250	20	180	9	50	130	122	16
26,251-26,750	20	180	9	50	130	122	16
26,751-27,250	20	180	9	50	130	122	16
27,251-27,750	20	180	9	50	130	122	16
27,751-28,250	25	180	9	56	124	116	16
28,251-28,750	25	180	9	56	124	116	16
28,751-29,250	25	180	9	56	124	116	16
29,251-29,750	25	200	9	56	144	136	16
29,751-30,250	25	200	9	56	144	136	16
30,251-30,750	25	200	9	56	144	136	16
30,751-31,250	25	200	9	56	144	136	16
31,251-31,750	25	200	9	56	144	136	16
31,751-32,250	25	200	9	56	144	136	18
32,251-32,750	25	200	9	56	144	136	18
32,751-33,250	25	200	9	56	144	136	18
33,251-33,750	25	200	9	56	144	136	18
33,751-34,250	25	200	9	56	144	136	18
34,251-34,750	25	200	9	56	144	136	18
34,751-35,250	25	200	9	56	144	136	18
35,251-35,750	25	200	9	56	144	136	18
35,751-36,250	32	200	9	60	140	132	18
36,251-36,750	32	200	9	60	140	132	18
36,751-37,250	32	200	9	60	140	132	18
37,251-37,750	32	200	9	60	140	132	18
37,751-38,250	32	200	9	60	140	132	18
38,251-38,750	32	200	9	60	140	132	18
38,751-39,250	32	200	9	60	140	132	18
39,251-39,750	32	200	9	60	140	132	18
39,751-40,250	32	200	9	60	140	132	18

Dimensions in mm. Cutting data see page 367 ff.

Information on special designs and other coatings on request.



MODULAR REAMING

Introduction

Programme overview _____ 132

Replaceable head systems

XR replaceable head reamers _____ 135

Multicut cutting rings _____ 155

Shell reamers without internal coolant supply _____ 185



PROGRAMME OVERVIEW

Modular reaming - replaceable head systems

To counter the rising tool costs, BECK has modular tool systems in its product range that offer a particularly high degree of flexibility as the tool holders can be fitted with different reaming elements via defined connections. Short tool change times, generally without re-measuring, make this type of tools attractive for medium and large lot sizes as the change can be carried out directly at the machine.

For the high-performance range, the XR replaceable head reamer is available as a variant made of solid carbide with special coatings or as a variant with brazed blades made of carbide (also coated), cermet or PCD in the diameter range 8-40 mm. Large diameters (20-200 mm) can be optimally machined with the MULTICUT cutting ring programme. Cutting materials such as cermet, carbide or coated carbide are used.













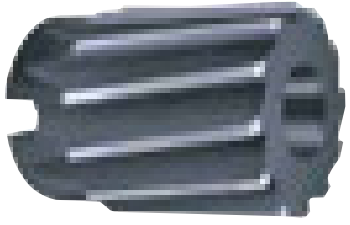

Basic Line:
Universal tools, broad application area, low procurement costs



Performance Line:
High-performance tools, broad application area, high productivity in series production



Expert Line:
Specialist tools for selected applications, maximum precision and productivity

XR replaceable head system	MultiCut cutting ring system	Shell reamers without IC
		
<p>Solid carbide design with brazed blades with matching holder range.</p> <p>Ø range: 8.00-40.00 mm*</p>   	<p>Cutting rings with matching holder range.</p> <p>Ø range: 21.60 - 200.59 mm*</p>   	<p>Shell reamers in accordance to DIN made of HSS and carbide with matching tool holders in accordance to DIN 217.</p> <p>Ø range: 25.00 - 100.00 mm*</p>   
<p>Page 135</p>	<p>Page 155</p>	<p>Page 185</p>

* Diameter range can vary, depending on the series.



XR tool features in detail

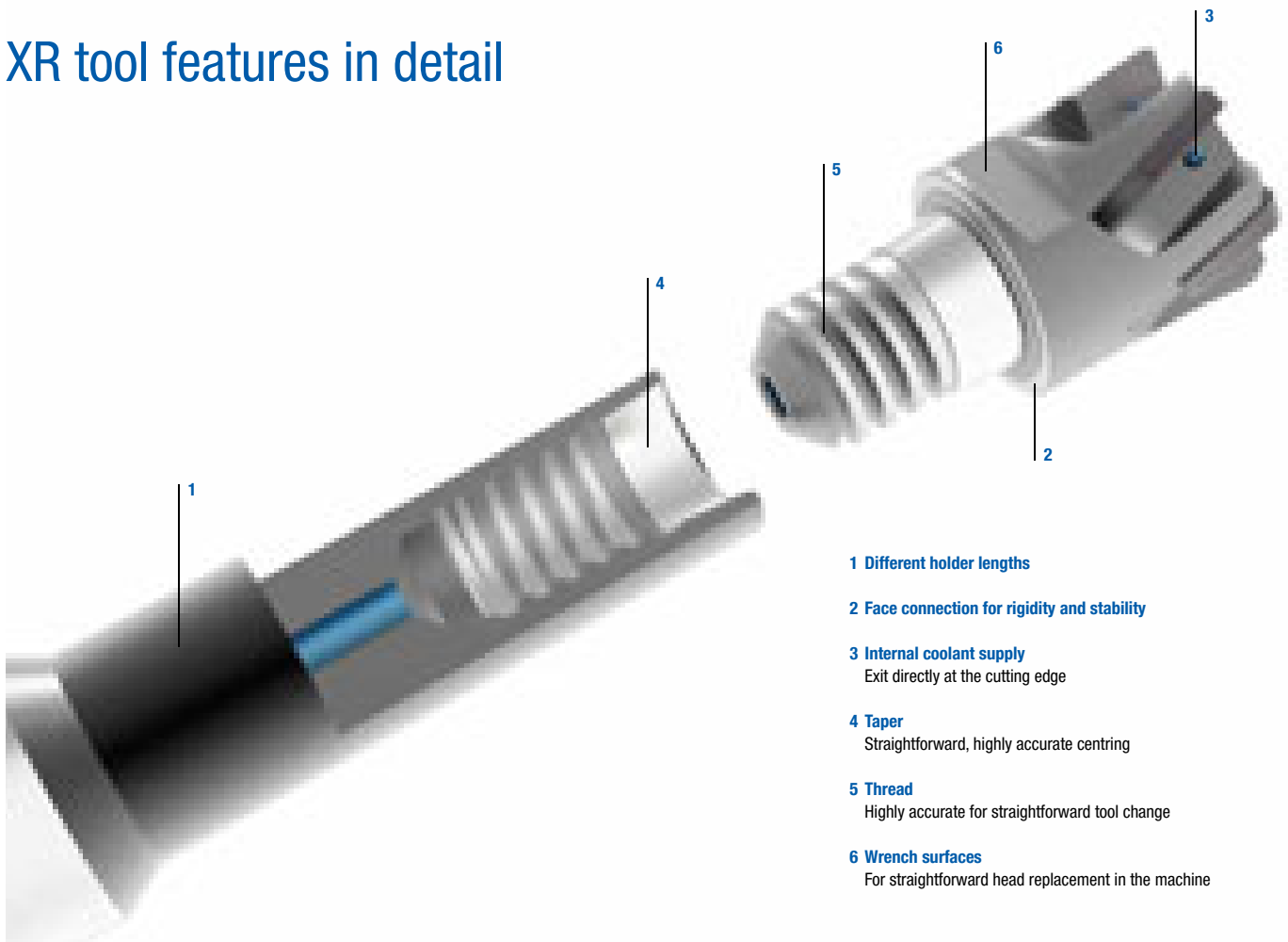

1 Different holder lengths

2 Face connection for rigidity and stability

3 Internal coolant supply
Exit directly at the cutting edge

4 Taper
Straightforward, highly accurate centring

5 Thread
Highly accurate for straightforward tool change

6 Wrench surfaces
For straightforward head replacement in the machine





REPLACEABLE HEAD REAMERS XR

Series for through bore

XR 06, solid carbide, BSP coated	081631	136
XR 01, carbide, uncoated	081610	137
XR 01, carbide, BSP coated	081618	138
XR 01, carbide, BVA coated	081611	139
XR 01, cermet, uncoated	081612	140
XR 01, PCD blades	081605	141
Overview configurable series		142

Series for blind bore

XR 06, solid carbide, BSP coated	081661	144
XR 01, carbide, uncoated	081650	145
XR 01, carbide, BSP coated	081651	146
XR 01, carbide, BVA coated	081659	147
XR 01, cermet, uncoated	081652	148
XR 01, PCD blades	081655	149
Overview configurable series		150

XR replaceable head holder

Holder programme		152
Accessories		153

XR 06 | 081631

Preferred series for through bore, internal coolant supply

Design:

Diameter:
Cutting direction:
Cutting material:

8,00-40,00 mm
Right-hand cutting
Solid carbide,
BSP coated

Flute direction:
Geometry:

Left-hand fluted
HPC geometry

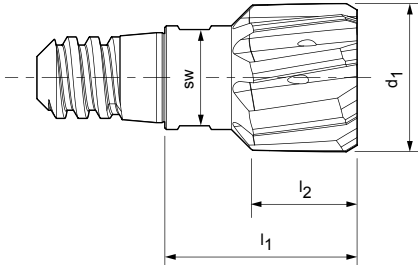

Dimensions				z	SW	Order No.
d ₁ H7	XS	l ₁	l ₂			
8,00	6	18	10	6	6	30461204
8,50	6	18	10	6	6	30461206
9,00	6	18	10	6	6	30461208
9,50	6	18	10	6	6	30461211
10,00	6	18	10	6	6	30461213
10,50	6	18	10	6	6	30461225
11,00	8	20	10	6	8	30461226
11,50	8	20	10	6	8	30461227
12,00	8	20	10	6	8	30461229
12,50	8	20	10	6	8	30461231
13,00	10	22	10	6	10	30461232
14,00	10	22	12	6	10	30461237
15,00	10	22	12	6	10	30461239
16,00	10	22	12	6	10	30461243
17,00	10	22	12	8	10	30461244
18,00	12	26	14	8	13	30461245
19,00	12	26	14	8	13	30461248
20,00	12	26	14	8	13	30461249
21,00	12	26	14	8	13	30552610
22,00	16	26	14	8	16	30552611
23,00	16	26	14	8	16	30552612
24,00	16	26	14	8	16	30552613
25,00	16	26	14	8	16	30552614
26,00	16	26	14	8	16	30552615
27,00	16	26	14	8	16	30552616
28,00	16*	26	14	8	24	30552617
29,00	16*	26	14	8	24	30552618
30,00	16*	26	14	8	24	30552619
31,00	16*	30	14	8	24	30552620
32,00	16*	30	14	8	24	30552621
33,00	16*	30	14	8	24	30552622
34,00	16*	30	14	8	24	30552623
35,00	16*	30	14	8	24	30552624
36,00	16*	30	14	8	24	30552625
37,00	16*	30	14	8	24	30552626
38,00	16*	30	14	8	24	30552627
39,00	16*	30	14	8	24	30552628
40,00	16*	30	14	8	24	30540962

Dimensions in mm.

Cutting data see page 367 ff.

Intermediate diameters and special tolerances can be ordered by the overview pages for configurable series on page 142.

* Relevant replaceable head holders with enlarged face connection (XS 16), from ø 28 mm, see page 152.

XR 01 I 081610

Preferred series for through bore, with brazed blades, internal coolant supply

Design:

Diameter:	8,00-40,00 mm
Cutting direction:	Right-hand cutting
Cutting material:	Carbide, uncoated
Flute direction:	Left-hand fluted
Lead angle:	30°
Rake angle:	6°

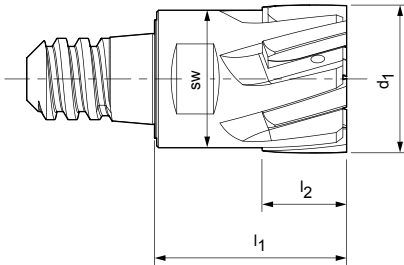

Dimensions				z	SW	Order No.
d ₁ H7	XS	l ₁	l ₂			
8,00	6	18	8	4	6	30516058
10,00	6	18	8	6	8	30516059
12,00	8	20	8	6	8	30516060
14,00	10	22	8	6	10	30516061
16,00	10	22	8	6	10	30516062
18,00	12	26	12	6	13	30516063
20,00	12	26	12	6	16	30516064
22,00	16	26	12	6	16	30516065
24,00	16	26	12	6	16	30516066
25,00	16	26	12	6	19	30516067
26,00	16	26	12	6	19	30516068
28,00	16	26	12	6	21	30516069
30,00	16	26	12	8	24	30516070
32,00	24	30	12	8	24	30516071
34,00	24	30	12	8	27	30516072
36,00	24	30	12	8	30	30516073
38,00	24	30	12	8	30	30516074
40,00	24	30	12	8	30	30516075

Dimensions in mm.
 Cutting data see page 367 ff.
 Replaceable head holders see page 152.
 Intermediate diameters and special tolerances can be ordered by the overview pages for configurable series on page 142.

XR 01 I 081618

Preferred series for through bore, with brazed blades, internal coolant supply

Design:

Diameter: 8,00-40,00 mm
 Cutting direction: Right-hand cutting
 Cutting material: Carbide, BSP coated
 Flute direction: Left-hand fluted
 Lead angle: 30°
 Rake angle: 6°

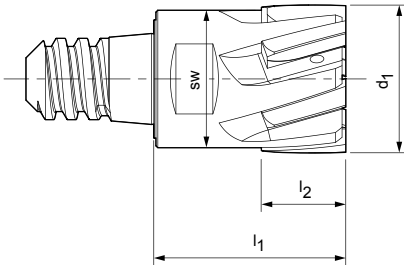

Dimensions				z	SW	Order No.
d ₁ H7	XS	l ₁	l ₂			
8,00	6	18	8	4	6	30432555
10,00	6	18	8	6	8	30432556
12,00	8	20	8	6	8	30432557
14,00	10	22	8	6	10	30432558
16,00	10	22	8	6	10	30432559
18,00	12	26	12	6	13	30432560
20,00	12	26	12	6	16	30432561
22,00	16	26	12	6	16	30432562
24,00	16	26	12	6	16	30432563
25,00	16	26	12	6	19	30432564
26,00	16	26	12	6	19	30432565
28,00	16	26	12	6	21	30432566
30,00	16	26	12	8	24	30432567
32,00	24	30	12	8	24	30432667
34,00	24	30	12	8	27	30432669
36,00	24	30	12	8	30	30432670
38,00	24	30	12	8	30	30432671
40,00	24	30	12	8	30	30432672

Dimensions in mm.
 Cutting data see page 367 ff.
 Replaceable head holders see page 152.
 Intermediate diameters and special tolerances can be ordered by the overview pages for configurable series on page 142.

XR 01 I 081611

Preferred series for through bore, with brazed blades, internal coolant supply

Design:

Diameter:	8,00-40,00 mm
Cutting direction:	Right-hand cutting
Cutting material:	Carbide, BVA coated
Flute direction:	Left-hand fluted
Lead angle:	30°
Rake angle:	6°

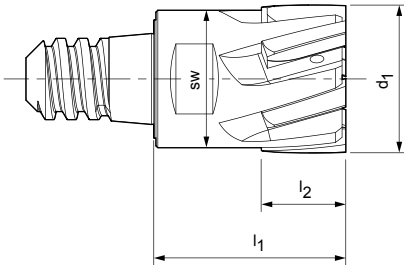

Dimensions				z	SW	Order No.
d_1 H7	XS	l_1	l_2			
8,00	6	18	8	4	6	30383184
10,00	6	18	8	6	8	30383185
12,00	8	20	8	6	8	30383186
14,00	10	22	8	6	10	30383187
16,00	10	22	8	6	10	30383188
18,00	12	26	12	6	13	30383189
20,00	12	26	12	6	16	30383190
22,00	16	26	12	6	16	30383191
24,00	16	26	12	6	16	30383192
25,00	16	26	12	6	19	30383193
26,00	16	26	12	6	19	30383194
28,00	16	26	12	6	21	30383195
30,00	16	26	12	8	24	30383196
32,00	24	30	12	8	24	30455216
34,00	24	30	12	8	27	30455217
36,00	24	30	12	8	30	30455218
38,00	24	30	12	8	30	30455219
40,00	24	30	12	8	30	30455220

Dimensions in mm.
 Cutting data see page 367 ff.
 Replaceable head holders see page 152.
 Intermediate diameters and special tolerances can be ordered by the overview pages for configurable series on page 142.

XR 01 | 081612

Preferred series for through bore, with brazed blades, internal coolant supply

Design:

Diameter:	8,00-40,00 mm
Cutting direction:	Right-hand cutting
Cutting material:	Cermet, uncoated
Flute direction:	Left-hand fluted
Lead angle:	30°
Rake angle:	6°

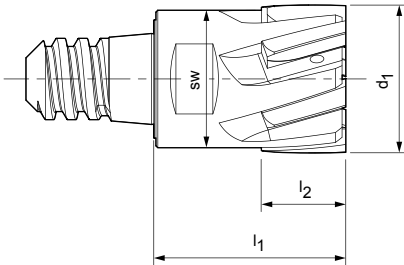

Dimensions				z	SW	Order No.
d_1 H7	XS	l_1	l_2			
8,00	6	18	8	4	6	30383155
10,00	6	18	8	6	8	30383172
12,00	8	20	8	6	8	30383173
14,00	10	22	8	6	10	30383174
16,00	10	22	8	6	10	30383175
18,00	12	26	12	6	13	30383176
20,00	12	26	12	6	16	30383177
22,00	16	26	12	6	16	30383178
24,00	16	26	12	6	16	30383179
25,00	16	26	12	6	19	30383180
26,00	16	26	12	6	19	30383181
28,00	16	26	12	6	21	30383182
30,00	16	26	12	8	24	30383183
32,00	24	30	12	8	24	30455211
34,00	24	30	12	8	27	30455212
36,00	24	30	12	8	30	30455213
38,00	24	30	12	8	30	30455214
40,00	24	30	12	8	30	30455215

Dimensions in mm.

Cutting data see page 367 ff.

Replaceable head holders see page 152.

Intermediate diameters and special tolerances can be ordered by the overview pages for configurable series on page 142.

XR 01 | 081605

Preferred series for through bore, with brazed blades, internal coolant supply

Design:

Diameter: 8,00-40,00 mm
 Cutting direction: Right-hand cutting
 Cutting material: PCD blades
 Flute direction: Straight fluted
 Lead angle: 45°
 Rake angle: 0°

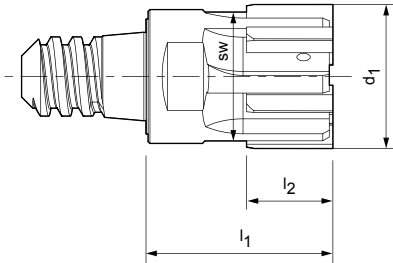

Dimensions				z	sw	Order No.
d ₁ H7	XS	l ₁	l ₂			
8,00	6	18	8	4	6	30383223
10,00	6	18	8	6	8	30383224
12,00	8	20	8	6	8	30383225
14,00	10	22	8	6	10	30383226
16,00	10	22	8	6	10	30383227
18,00	12	26	12	6	13	30383228
20,00	12	26	12	6	16	30383229
22,00	16	26	12	6	16	30383230
24,00	16	26	12	6	16	30383231
25,00	16	26	12	6	19	30383232
26,00	16	26	12	6	19	30383233
28,00	16	26	12	6	21	30383234
30,00	16	26	12	8	24	30383235
32,00	24	30	12	8	24	30455232
34,00	24	30	12	8	27	30455233
36,00	24	30	12	8	30	30455235
38,00	24	30	12	8	30	30455236
40,00	24	30	12	8	30	30455237

Dimensions in mm.
 Cutting data see page 367 ff.
 Replaceable head holders see page 152.
 Intermediate diameters and special tolerances can be ordered by the overview pages for configurable series on page 142.

XR overview

Configurable series for through bore, internal coolant supply

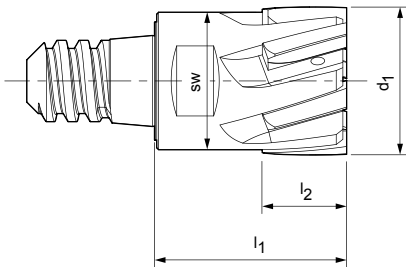

Design:	081610	081611
Diameter:	8,000-40,200 mm	8,000-40,200 mm
Cutting direction:	Right-hand cutting	Right-hand cutting
Cutting material:	Carbide, uncoated	Carbide, BVA coated
Flute direction:	Left-hand fluted	Left-hand fluted
Lead angle:	30°	30°
Rake angle:	6°	6°

XR 01

	P	1	2	3	4	5	6	M	1	2	3	K	1	2	3	N	1	2	3	4	S	1	2	3	4	5	H	1	2
081610																													
081611																													
081612																													
081618																													
081605																													

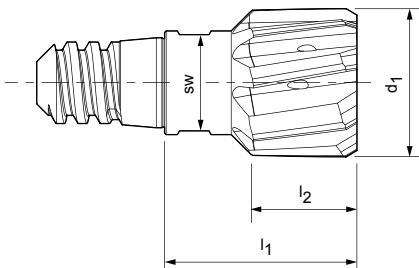

Design:	081631
Diameter:	8,000-40,200 mm
Cutting direction:	Right-hand cutting
Cutting material:	Solid carbide, BSP coated
Flute direction:	Left-hand fluted
Geometry:	HPC geometry

XR 06

	P	1	2	3	4	5	6	M	1	2	3	K	1	2	3	N	1	2	3	4	S	1	2	3	4	5	H	1	2
081631																													



Order example:

1. BECK product code	2. Diameter	3. Tolerance	4. Connection
0 8 1 6 1 8 -	1 2 . 2 0 0	H 7	- X S 2 0
BECK product code	Bore diameter	IT or tolerance in µm	Connection size in mm

081612

8,000-40,200 mm
Right-hand cutting
Cermet, uncoated
Left-hand fluted
30°
6°

081618

8,000-40,200 mm
Right-hand cutting
Carbide, BSP coated
Left-hand fluted
30°
6°

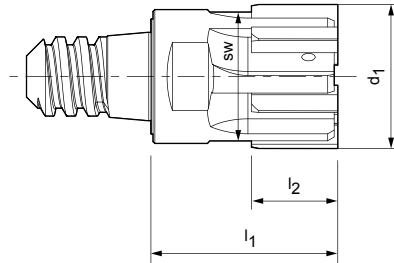

Design:

Diameter:
Cutting direction:
Cutting material:
Flute direction:
Lead angle:
Rake angle:

081605

8,000-40,200 mm
Right-hand cutting
PCD blades
Straight fluted
45°
0°

XR 01

Dimensions				z	sw
d ₁	XS	l ₁	l ₂		
8.000-8.700	6	18	8	4	6
8.701-9.200	6	18	8	4	6
9.201-9.700	6	18	8	4	6
9.701-10.200	6	18	8	6	8
10.201-10.700	6	18	8	6	8
10.701-11.200	8	20	8	6	8
11.201-11.700	8	20	8	6	8
11.701-12.200	8	20	8	6	8
12.201-12.700	8	20	8	6	8
12.701-13.200	10	22	8	6	10
13.201-14.200	10	22	8	6	10
14.201-15.200	10	22	8	6	10
15.201-16.200	10	22	8	6	10
16.201-17.200	10	22	8	6	13
17.201-18.200	12	26	12	6	13
18.201-19.200	12	26	12	6	13
19.201-20.200	12	26	12	6	16
20.201-21.200	12	26	12	6	16
21.201-22.200	16	26	12	6	16
22.201-23.200	16	26	12	6	16
23.201-24.200	16	26	12	6	16
24.201-25.200	16	26	12	6	19
25.201-26.200	16	26	12	6	19
26.201-27.200	16	26	12	6	21
27.201-28.200	16	26	12	6	21
28.201-29.200	16	26	12	6	24
29.201-30.200	16	26	12	8	24
30.201-31.200	24	30	12	8	24
31.201-32.200	24	30	12	8	24
32.201-33.200	24	30	12	8	27
33.201-34.200	24	30	12	8	27
34.201-35.200	24	30	12	8	30
35.201-36.200	24	30	12	8	30
36.201-37.200	24	30	12	8	30
37.201-38.200	24	30	12	8	30
38.201-39.200	24	30	12	8	30
39.201-40.200	24	30	12	8	30

XR 06

Dimensions				z	sw
d ₁	XS	l ₁	l ₂		
8,000-8,200	6	18	10	6	6
8,201-8,700	6	18	10	6	6
8,701-9,200	6	18	10	6	6
9,201-9,700	6	18	10	6	6
9,701-10,200	6	18	10	6	6
10,201-10,700	6	18	10	6	6
10,701-11,200	8	20	10	6	8
11,201-11,700	8	20	10	6	8
11,701-12,200	8	20	10	6	8
12,201-12,700	8	20	10	6	8
12,701-13,200	10	22	10	6	10
13,201-14,200	10	22	12	6	10
14,201-15,200	10	22	12	6	10
15,201-16,200	10	22	12	6	10
16,201-17,200	10	22	12	8	10
17,201-18,200	12	26	14	8	13
18,201-19,200	12	26	14	8	13
19,201-20,200	12	26	14	8	13
20,201-21,200	12	26	14	8	13
21,201-22,200	16	26	14	8	16
22,201-23,200	16	26	14	8	16
23,201-24,200	16	26	14	8	16
24,201-25,200	16	26	14	8	16
25,201-26,200	16	26	14	8	16
26,201-27,200	16	26	14	8	16
27,201-28,200	16*	26	14	8	24
28,201-29,200	16*	26	14	8	24
29,201-30,200	16*	26	14	8	24
30,201-31,200	16*	30	14	8	24
31,201-32,200	16*	30	14	8	24
32,201-33,200	16*	30	14	8	24
33,201-34,200	16*	30	14	8	24
34,201-35,200	16*	30	14	8	24
35,201-36,200	16*	30	14	8	24
36,201-37,200	16*	30	14	8	24
37,201-38,200	16*	30	14	8	24
38,201-39,200	16*	30	14	8	24
39,201-40,200	16*	30	14	8	24

Dimensions in mm.

Cutting data see page 367 ff.

* Relevant replaceable head holders with enlarged face connection (XS 16), from \varnothing 28 mm, see page 152.

XR 06 | 081661

Preferred series for blind bore, internal coolant supply

Design:

Diameter: 10,00-40,00 mm
 Cutting direction: Right-hand cutting
 Cutting material: Solid carbide, BSP coated
 Flute direction: Straight fluted
 Geometry: HPC geometry

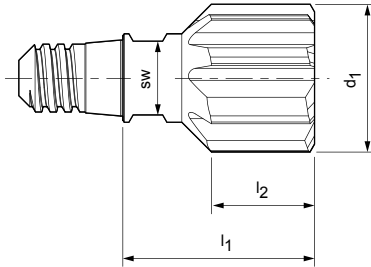

Dimensions				z	SW	Order No.
d_1 H7	XS	l_1	l_2			
10,00	6	18	10	6	6	30461250
10,50	6	18	10	6	6	30461259
11,00	6	20	10	6	6	30461261
11,50	6	20	10	6	6	30461263
12,00	6	20	10	6	6	30461267
12,50	6	20	10	6	6	30461271
13,00	6	22	12	6	6	30461273
14,00	6	22	12	6	6	30461274
15,00	8	22	12	6	8	30461275
16,00	8	22	12	6	8	30461276
17,00	10	22	12	8	10	30461278
18,00	10	26	14	8	10	30461279
19,00	10	26	14	8	10	30461281
20,00	10	26	14	8	10	30461283
21,00	12	26	14	8	13	30552644
22,00	12	26	14	8	13	30552645
23,00	12	26	14	8	13	30552646
24,00	12	26	14	8	13	30552648
25,00	16	26	14	8	16	30552649
26,00	16	26	14	8	16	30552650
27,00	16	26	14	8	16	30552651
28,00	16	26	14	8	16	30552652
29,00	16	26	14	8	16	30552653
30,00	16	26	14	8	16	30552654
31,00	16	30	14	8	16	30552655
32,00	16	30	14	8	16	30552656
33,00	16*	30	14	8	24	30552657
34,00	16*	30	14	8	24	30552658
35,00	16*	30	14	8	24	30552659
36,00	16*	30	14	8	24	30552660
37,00	16*	30	14	8	24	30552661
38,00	16*	30	14	8	24	30552662
39,00	16*	30	14	8	24	30552663
40,00	16*	30	14	8	24	30552664

Dimensions in mm.

Cutting data see page 367 ff.

Intermediate diameters and special tolerances can be ordered by the overview pages for configurable series on page 150.

* Relevant replaceable head holders with enlarged face connection (XS 16), from \varnothing 33 mm, see page 152.

XR 01 | 081650

Preferred series for blind bore, with brazed blades, internal coolant supply

Design:

Diameter: 14,00-40,00 mm
 Cutting direction: Right-hand cutting
 Cutting material: Carbide, uncoated
 Flute direction: Straight fluted
 Lead angle: 60°
 Rake angle: 0°

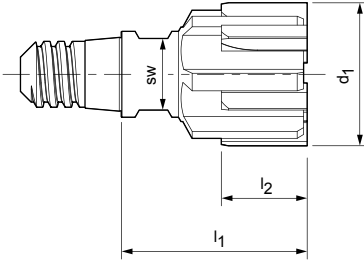

Dimensions				z	SW	Order No.
d_1 H7	XS	l_1	l_2			
14,00	6	22	8	6	6	30383271
16,00	8	22	8	6	8	30383272
18,00	10	26	12	6	10	30383273
20,00	10	26	12	6	10	30383274
22,00	12	26	12	6	13	30383275
24,00	12	26	12	6	13	30383276
25,00	16	26	12	6	16	30383277
26,00	16	26	12	6	16	30383278
28,00	16	26	12	6	16	30383279
30,00	16	26	12	8	16	30383280
32,00	16	30	12	8	16	30455254
34,00	24	30	12	8	24	30455256
36,00	24	30	12	8	24	30455257
38,00	24	30	12	8	24	30455258
40,00	24	30	12	8	24	30455259

Dimensions in mm.
 Cutting data see page 367 ff.
 Replaceable head holders see page 152.
 Intermediate diameters and special tolerances can be ordered by the overview pages for configurable series on page 150.

XR 01 | 081651

Preferred series for blind bore, with brazed blades, internal coolant supply

Design:

Diameter: 14,00-40,00 mm
 Cutting direction: Right-hand cutting
 Cutting material: Carbide, BSP coated
 Flute direction: Straight fluted
 Lead angle: 60°
 Rake angle: 0°

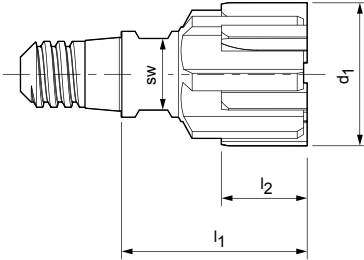

Dimensions				z	SW	Order No.
d_1 H7	XS	l_1	l_2			
14,00	6	22	8	6	6	30383259
16,00	8	22	8	6	8	30383260
18,00	10	26	12	6	10	30383261
20,00	10	26	12	6	10	30383262
22,00	12	26	12	6	13	30383263
24,00	12	26	12	6	13	30383264
25,00	16	26	12	6	16	30383265
26,00	16	26	12	6	16	30383267
28,00	16	26	12	6	16	30383268
30,00	16	26	12	8	16	30383269
32,00	16	30	12	8	16	30455248
34,00	24	30	12	8	24	30455250
36,00	24	30	12	8	24	30455251
38,00	24	30	12	8	24	30455252
40,00	24	30	12	8	24	30455253

Dimensions in mm.
 Cutting data see page 367 ff.
 Replaceable head holders see page 152.
 Intermediate diameters and special tolerances can be ordered by the overview pages for configurable series on page 150.

XR 01 | 081659

Preferred series for blind bore, with brazed blades, internal coolant supply

Design:

Diameter: 14,00-40,00 mm
 Cutting direction: Right-hand cutting
 Cutting material: Carbide, BVA coated
 Flute direction: Straight fluted
 Lead angle: 60°
 Rake angle: 0°

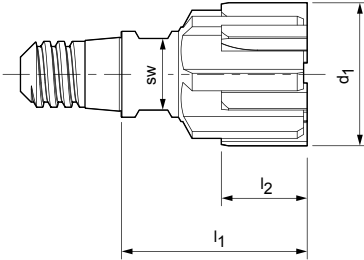

Dimensions				z	SW	Order No.
d_1 H7	XS	l_1	l_2			
14,00	6	22	8	6	6	30383248
16,00	8	22	8	6	8	30383249
18,00	10	26	12	6	10	30383250
20,00	10	26	12	6	10	30383251
22,00	12	26	12	6	13	30383252
24,00	12	26	12	6	13	30383253
25,00	16	26	12	6	16	30383254
26,00	16	26	12	6	16	30383255
28,00	16	26	12	6	16	30383256
30,00	16	26	12	8	16	30383257
32,00	16	30	12	8	16	30455243
34,00	24	30	12	8	24	30455244
36,00	24	30	12	8	24	30455245
38,00	24	30	12	8	24	30455246
40,00	24	30	12	8	24	30455247

Dimensions in mm.
 Cutting data see page 367 ff.
 Replaceable head holders see page 152.
 Intermediate diameters and special tolerances can be ordered by the overview pages for configurable series on page 150.

XR 01 | 081652

Preferred series for blind bore, with brazed blades, internal coolant supply

Design:

Diameter: 14,00-40,00 mm
 Cutting direction: Right-hand cutting
 Cutting material: Cermet, uncoated
 Flute direction: Straight fluted
 Lead angle: 60°
 Rake angle: 0°

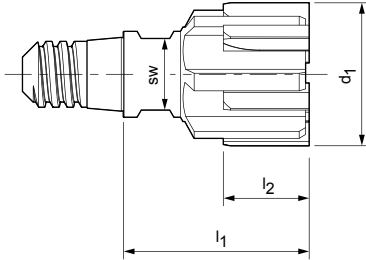

Dimensions				z	SW	Order No.
d_1 H7	XS	l_1	l_2			
14,00	6	22	8	6	6	30383237
16,00	8	22	8	6	8	30383238
18,00	10	26	12	6	10	30383239
20,00	10	26	12	6	10	30383240
22,00	12	26	12	6	13	30383241
24,00	12	26	12	6	13	30383242
25,00	16	26	12	6	16	30383243
26,00	16	26	12	6	16	30383244
28,00	16	26	12	6	16	30383245
30,00	16	26	12	8	16	30383246
32,00	16	30	12	8	16	30455238
34,00	24	30	12	8	24	30455239
36,00	24	30	12	8	24	30455240
38,00	24	30	12	8	24	30455241
40,00	24	30	12	8	24	30455242

Dimensions in mm.
 Cutting data see page 367 ff.
 Replaceable head holders see page 152.
 Intermediate diameters and special tolerances can be ordered by the overview pages for configurable series on page 150.

XR 01 | 081655

Preferred series for blind bore, with brazed blades, internal coolant supply

Design:

Diameter: 14,00-40,00 mm
 Cutting direction: Right-hand cutting
 Cutting material: PCD blades
 Flute direction: Straight fluted
 Lead angle: 75°
 Rake angle: 0°

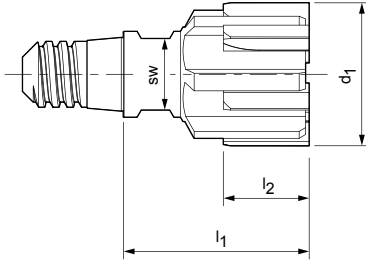

Dimensions				z	SW	Order No.
d_1 H7	XS	l_1	l_2			
14,00	6	22	8	6	6	30383282
16,00	8	22	8	6	8	30383283
18,00	10	26	12	6	10	30383284
20,00	10	26	12	6	10	30383285
22,00	12	26	12	6	13	30383286
24,00	12	26	12	6	13	30383287
25,00	16	26	12	6	16	30383288
26,00	16	26	12	6	16	30383289
28,00	16	26	12	6	16	30383290
30,00	16	26	12	8	16	30383291
32,00	16	30	12	8	16	30455260
34,00	24	30	12	8	24	30455261
36,00	24	30	12	8	24	30455262
38,00	24	30	12	8	24	30455263
40,00	24	30	12	8	24	30455264

Dimensions in mm.
 Cutting data see page 367 ff.
 Replaceable head holders see page 152.
 Intermediate diameters and special tolerances can be ordered by the overview pages for configurable series on page 150.

XR overview

Configurable series for blind bore, internal coolant supply

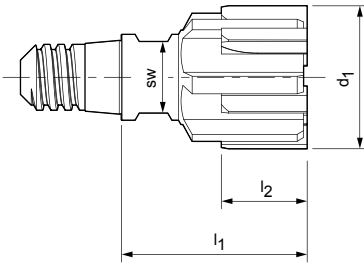

Design:

Diameter:
Cutting direction:
Cutting material:
Flute direction:
Lead angle:
Rake angle:

081650

12,201-40,200 mm
Right-hand cutting
Carbide, uncoated
Straight fluted
60°
0°

081651

12,201-40,200 mm
Right-hand cutting
Carbide, BSP coated
Straight fluted
60°
0°

XR 01

	P	1	2	3	4	5	6	M	1	2	3	K	1	2	3	N	1	2	3	4	S	1	2	3	4	5	H	1	2
081650																													
081651																													
081652																													
081659																													
081655																													

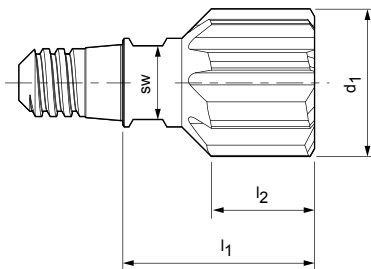

Design:

Diameter:
Cutting direction:
Cutting material:
Flute direction:
Geometry:

9,701-40,200 mm
Right-hand cutting
Solid carbide,
BSP coated
Straight fluted
HPC geometry

XR 06

	P	1	2	3	4	5	6	M	1	2	3	K	1	2	3	N	1	2	3	4	S	1	2	3	4	5	H	1	2
081661																													



Order example:

1. BECK product code

0 8 1 6 5 0

BECK product code

2. Diameter

2 4 . 2 6 5

Bore diameter

3. Tolerance

H 7

IT or tolerance in µm

4. Connection

X S 1 6

Connection size in mm

Hyphen

Hyphen

081652

12,201-40,200 mm
Right-hand cutting
Cermet, uncoated
Straight fluted
60°
0°

081659

12,201-40,200 mm
Right-hand cutting
Carbide, BVA coated
Straight fluted
60°
0°

081655

12,201-40,200 mm
Right-hand cutting
PCD blades
Straight fluted
75°
0°

XR 01

Dimensions				z	sw
d ₁	XS	l ₁	l ₂		
12,201-12,700	6	20	8	6	6
12,701-13,200	6	22	8	6	6
13,201-14,200	6	22	8	6	6
14,201-15,200	8	22	8	6	8
15,201-16,200	8	22	8	6	8
16,201-17,200	10	22	8	6	10
17,201-18,200	10	26	12	6	10
18,201-19,200	10	26	12	6	10
19,201-20,200	10	26	12	6	10
20,201-21,200	12	26	12	6	13
21,201-22,200	12	26	12	6	13
22,201-23,200	12	26	12	6	13
23,201-24,200	12	26	12	6	13
24,201-25,200	16	26	12	6	16
25,201-26,200	16	26	12	6	16
26,201-27,200	16	26	12	6	16
27,201-28,200	16	26	12	6	16
28,201-29,200	16	26	12	6	16
29,201-30,200	16	26	12	8	16
30,201-31,200	16	30	12	8	16
31,201-32,200	16	30	12	8	16
32,201-33,200	24	30	12	8	24
33,201-34,200	24	30	12	8	24
34,201-35,200	24	30	12	8	24
35,201-36,200	24	30	12	8	24
36,201-37,200	24	30	12	8	24
37,201-38,200	24	30	12	8	24
38,201-39,200	24	30	12	8	24
39,201-40,200	24	30	12	8	24

XR 06

Dimensions				z	sw
d ₁	XS	l ₁	l ₂		
9,701-10,200	6	18	10	6	6
10,201-10,700	6	18	10	6	6
10,701-11,200	6	20	10	6	6
11,201-11,700	6	20	10	6	6
11,701-12,200	6	20	10	6	6
12,201-12,700	6	20	10	6	6
12,701-13,200	6	22	12	6	6
13,201-14,200	6	22	12	6	6
14,201-15,200	8	22	12	6	8
15,201-16,200	8	22	12	6	8
16,201-17,200	10	22	12	8	10
17,201-18,200	10	26	14	8	10
18,201-19,200	10	26	14	8	10
19,201-20,200	10	26	14	8	10
20,201-21,200	12	26	14	8	13
21,201-22,200	12	26	14	8	13
22,201-23,200	12	26	14	8	13
23,201-24,200	12	26	14	8	13
24,201-25,200	16	26	14	8	16
25,201-26,200	16	26	14	8	16
26,201-27,200	16	26	14	8	16
27,201-28,200	16	26	14	8	16
28,201-29,200	16	26	14	8	16
29,201-30,200	16	26	14	8	16
30,201-31,200	16	30	14	8	16
31,201-32,200	16	30	14	8	16
32,201-33,200	16*	30	14	8	24
33,201-34,200	16*	30	14	8	24
34,201-35,200	16*	30	14	8	24
35,201-36,200	16*	30	14	8	24
36,201-37,200	16*	30	14	8	24
37,201-38,200	16*	30	14	8	24
38,201-39,200	16*	30	14	8	24
39,201-40,200	16*	30	14	8	24

Dimensions in mm.

Cutting data see page 367 ff.

* Relevant replaceable head holders with enlarged face connection (XS 16), from ø 32,201 mm, see page 152.

XR replaceable head holder I 085101

Cylindrical shank design with XS connection,
internal coolant supply

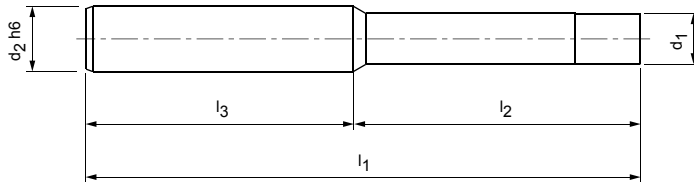

Dimensions						Order No.
d ₁	XS	d ₂ h6	l ₁	l ₂	l ₃	
7,80	6	10	60	20	40	30350736
7,80	6	10	85	45	40	30350737
7,80	6	10	150	110	40	30350738
9,80	8	12	70	25	45	30350742
9,80	8	12	90	45	45	30350743
9,80	8	12	150	105	45	30350744
11,80	10	16	70	22	48	30350747
11,80	10	16	90	42	48	30350748
11,80	10	16	150	102	48	30350749
15,80	12	16	80	32	48	30350752
15,80	12	16	105	57	48	30350753
15,80	12	16	150	102	48	30350754
15,80	12	16	200	152	48	30350755
19,80	16*	25	90	34	56	30350758
19,80	16*	25	120	64	56	30350759
19,80	16*	25	200	144	56	30350760
19,80	16*	25	250	194	56	30350761
27,80	24	32	90	30	60	30371461
27,80	24	32	120	60	60	30371464
27,80	24	32	200	140	60	30371467

With enlarged face connection for replaceable head reamers XR 06 from \varnothing 27,201 for through bore and from \varnothing 32,201 for blind bore

26	16	25	90	34	56	30839581
26	16	25	120	64	56	30839582
26	16	25	200	144	56	30839583
26	16	25	250	194	56	30839584

Dimensions in mm.

* For replaceable head reamers XR 06 from \varnothing 27,201 (for through bore) and from \varnothing 32,201 mm (for blind bore) use holder with enlarged face connection (see table below)!

Installation wrench Combination wrench

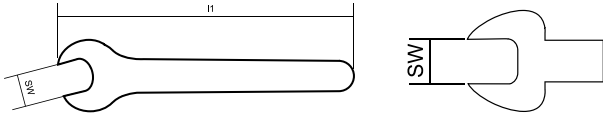

Torque wrench for combination wrench

SW	Order No. Installation wrench	Order No. Combination wrench
6	30352660	30376387
8	30352661	30376388
10	30352662	30376390
13	30352663	30376392
16	30352667	30376394
19	30394085	30394090
21	30352668	30376395
24	30352669	30376396
27	30394086	30394091
30	30394087	30394092

Attachment shank	Torque (Nm)	Total length	Order No.
9x12	2-25	274,0	30386735
14x18	20-200	470,5	30386736





MultiCut

The BECK MultiCut reamers with re-adjustable cutting rings make it possible to fine machining bores down to a tolerance range below IT7. Straightforward handling on setting and measuring the cutting rings as well as the possibility of combining with various holders are advantages of this system. Re-adjustable cutting rings are manufactured to half the stipulated tolerance.

Cutting rings

Adjustable cutting rings _____ 156

Holder

Holder programme _____ 159

Accessories _____ 180

Adjustable cutting ring MN73101

Design:

Diameter:

21,60-200,59 mm

Cutting material:

Carbide, uncoated

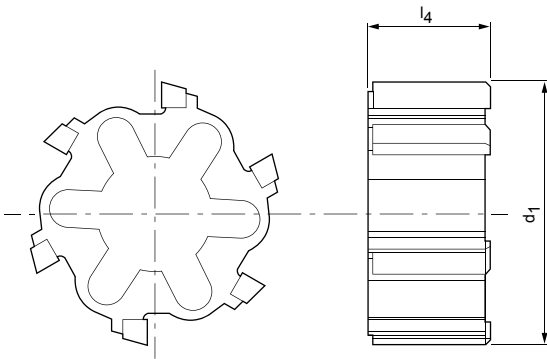

Dimensions		z
d ₁	l ₄	
21,60-25,59	11,5	6
25,60-28,59	13,5	6
28,60-32,59	13,5	6
32,60-36,59	15,5	6
36,60-40,59	15,5	6
40,60-45,59	15,5	6
45,60-50,59	18,5	6
50,60-55,59	18,5	6
55,60-60,59	18,5	6
60,60-65,59	18,5	6
65,60-70,59	18,5	6
70,60-75,59	18,5	6
75,60-79,59	18,5	6
79,60-85,59	18,5	8
85,60-90,59	18,5	8
90,60-95,59	18,5	8
95,60-100,59	18,5	8
100,60-110,59	18,5	10
110,60-115,59	18,5	12
115,60-120,59	18,5	12
120,60-125,59	18,5	12
125,60-139,59	18,5	12
139,60-145,59	18,5	12
145,60-155,59	18,5	12
155,60-165,59	18,5	12
165,60-175,59	18,5	12
175,60-185,59	18,5	12
185,60-195,59	18,5	12
195,60-200,59	18,5	12

Required ordering designations

Type	ø	Tolerance	Cutting material	Lead angle
e.g. MN73101	45,75	H7	carbide	45°

Dimensions in mm.
Cutting data see page 367 ff.

Please note that the holder and cutting ring must be ordered separately.
The tools are supplied fully assembled and set to the nominal size.

Adjustable cutting ring MN73102

Design:

Diameter:

21,60-200,59 mm

Cutting material:

Carbide, TiN coated

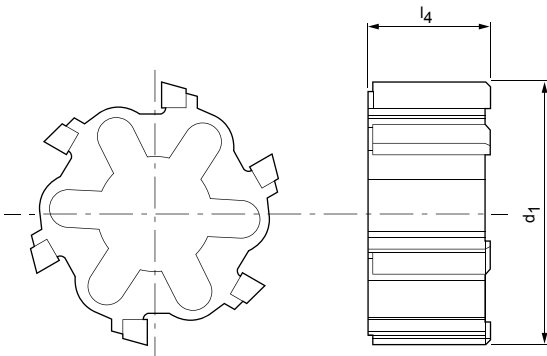

Dimensions		z
d ₁	l ₄	
21,60-25,59	11,5	6
25,60-28,59	13,5	6
28,60-32,59	13,5	6
32,60-36,59	15,5	6
36,60-40,59	15,5	6
40,60-45,59	15,5	6
45,60-50,59	18,5	6
50,60-55,59	18,5	6
55,60-60,59	18,5	6
60,60-65,59	18,5	6
65,60-70,59	18,5	6
70,60-75,59	18,5	6
75,60-79,59	18,5	6
79,60-85,59	18,5	8
85,60-90,59	18,5	8
90,60-95,59	18,5	8
95,60-100,59	18,5	8
100,60-110,59	18,5	10
110,60-115,59	18,5	12
115,60-120,59	18,5	12
120,60-125,59	18,5	12
125,60-139,59	18,5	12
139,60-145,59	18,5	12
145,60-155,59	18,5	12
155,60-165,59	18,5	12
165,60-175,59	18,5	12
175,60-185,59	18,5	12
185,60-195,59	18,5	12
195,60-200,59	18,5	12

Required ordering designations

Type	ø	Tolerance	Cutting material	Lead angle
e.g. MN73102	45,75	H7	carbide	45°

Dimensions in mm.
Cutting data see page 367 ff.

Please note that the holder and cutting ring must be ordered separately.
The tools are supplied fully assembled and set to the nominal size.

Adjustable cutting ring MN73104

Design:

Diameter:

21,60-200,59 mm

Cutting material:

Cermet, uncoated

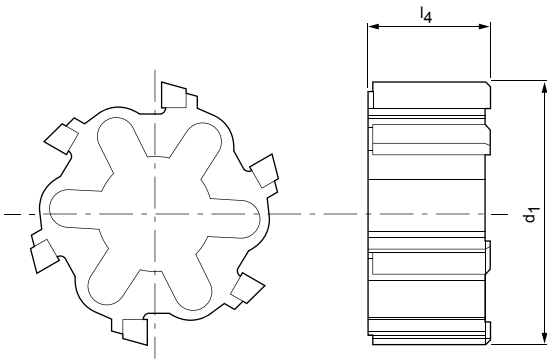

Dimensions		z
d ₁	l ₄	
21,60-25,59	11,5	6
25,60-28,59	13,5	6
28,60-32,59	13,5	6
32,60-36,59	15,5	6
36,60-40,59	15,5	6
40,60-45,59	15,5	6
45,60-50,59	18,5	6
50,60-55,59	18,5	6
55,60-60,59	18,5	6
60,60-65,59	18,5	6
65,60-70,59	18,5	6
70,60-75,59	18,5	6
75,60-79,59	18,5	6
79,60-85,59	18,5	8
85,60-90,59	18,5	8
90,60-95,59	18,5	8
95,60-100,59	18,5	8
100,60-110,59	18,5	10
110,60-115,59	18,5	12
115,60-120,59	18,5	12
120,60-125,59	18,5	12
125,60-139,59	18,5	12
139,60-145,59	18,5	12
145,60-155,59	18,5	12
155,60-165,59	18,5	12
165,60-175,59	18,5	12
175,60-185,59	18,5	12
185,60-195,59	18,5	12
195,60-200,59	18,5	12

Required ordering designations

Type	ø	Tolerance	Cutting material	Lead angle
e.g. MN73104	45,75	H7	cermet	45°

Dimensions in mm.
Cutting data see page 367 ff.

Please note that the holder and cutting ring must be ordered separately.
The tools are supplied fully assembled and set to the nominal size.

Holder for cutting rings

Cylindrical shank with lateral clamping surface, without internal coolant supply

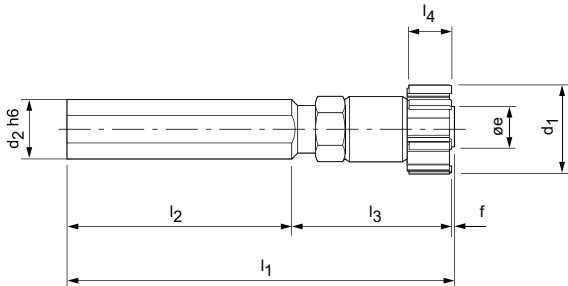

MN73237 - For through bore, short design

Dimensions									z	Size	Order No.
d_1	MK	d_2 h6	l_1	l_2	l_3	l_4	$\varnothing e$	f			
21,60-25,59	6	16	94	40	51	11,5	12	3	2	021,6	30008875
25,60-32,59	6	20	94,5	40	51	13,5	15,8	3,5	3	025,6	30008876
32,60-40,59	6	20	95,5	40	51	15,5	21,4	4,5	3	032,6	30008877
40,60-45,59	6	25	125	65	55	15,5	25,5	5	3	040,6	30022400
45,60-60,59	6	20	134	65	62	18,5	29,6	7	3	045,6	30006305
60,60-79,59	6	25	148	65	73	18,5	39,8	10	4	060,6	30022401
79,60-100,59	8	40	162,5	65	85	18,5	57	12,5	8	079,6	30183686

MN73238 - For through and blind bore, short design | Please notice $\varnothing e$ and f

21,60-25,59	6	16	92,8	40	51,8	11,5	11,2	1	2	021,6	30008882
25,60-32,59	6	20	93	40	52	13,5	15,2	1	3	025,6	30008883
32,60-40,59	6	20	92,5	40	51,5	15,5	20,3	1	3	032,6	30008884
40,60-45,59	6	25	121	65	55	15,5	24,1	1	3	040,6	30028685
45,60-60,59	6	20	129,5	65	63	18,5	27,8	1,5	3	045,6	30183680
60,60-79,59	6	25	141,5	65	75	18,5	37	1,5	4	060,6	30183681
79,60-100,59	8	40	154,5	65	88	18,5	53,2	1,5	5	079,6	30183682

Required ordering designations

Holder		+	Cutting ring					Accessories	
Type	Size		Type	\varnothing	Tolerance	Cutting material	Lead angle	Page	
e.g. MN73227	045,6		e.g. MN73101	45,75	H7	carbide	45°	180	

Holder for cutting rings

Cylindrical shank, with internal coolant supply

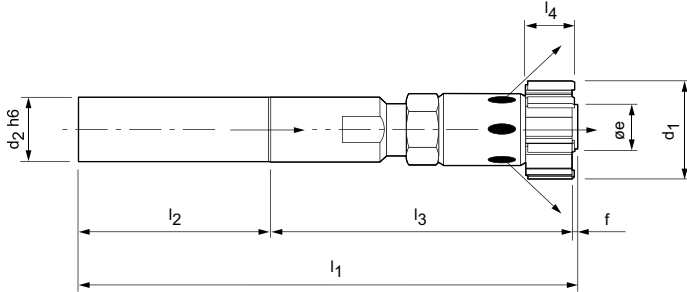

MN75236 - For through bore, short design

Dimensions								z	Size	Order No.
d ₁	d ₂ h6	l ₁	l ₂	l ₃	l ₄	øe	f			
21,60-25,59	20	132	50	81	11,5	11,2	1	6	021,6	30008889
25,60-32,59	20	153	50	102	13,5	15,2	1	6	025,6	30008900
32,60-36,59	25	159,5	56	102	15,5	20,3	1,5	6	032,6	30008901
36,60-40,59	25	159,5	56	102	15,5	20,3	1,5	6	036,6	30023642
40,60-45,59	25	159,5	56	102	15,5	24,1	1,5	6	040,6	30016440
45,60-50,59	32	166,5	60	105	18,5	27,8	1,5	6	045,6	30183643
50,60-60,59	32	166,5	60	105	18,5	27,8	1,5	6	050,6	30023643
60,60-70,59	32	166,5	60	105	18,5	37	1,5	6	060,6	30023644
70,60-79,59	32	166,5	60	105	18,5	37	1,5	6	070,6	30023645
79,60-90,59	40	176,5	70	105	18,5	53,2	1,5	8	079,6	30023646
90,60-100,59	40	176,5	70	105	18,5	53,2	1,5	8	090,6	30023647

Required ordering designations

Holder	
Type	Size
e.g. MN73227	045,6



Cutting ring				
Type	ø	Tolerance	Cutting material	Lead angle
e.g. MN73217	45,75	H7	carbide	45°

Accessories
Page
180

Holder for cutting rings

Cylindrical shank, with internal coolant supply

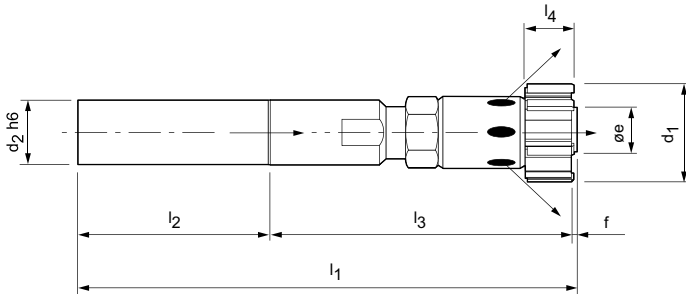

MN76236 - For blind bore, short design

Dimensions								z	Size	Order No.
d ₁	d ₂ h6	l ₁	l ₂	l ₃	l ₄	øe	f			
21,60-25,59	20	132	50	81	11,5	11,2	1	6	021,6	30183632
25,60-32,59	20	153	50	102	13,5	15,2	1	6	025,6	30183633
32,60-36,59	25	159,5	56	102	15,5	20,3	1,5	6	032,6	30183634
36,60-40,59	25	159,5	56	102	15,5	20,3	1,5	6	036,6	30183635
40,60-45,59	25	159,5	56	102	15,5	24,1	1,5	6	040,6	30183636
45,60-50,59	32	166,5	60	105	18,5	27,8	1,5	6	045,6	30183637
50,60-60,59	32	166,5	60	105	18,5	27,8	1,5	6	050,6	30183638
60,60-70,59	32	166,5	60	105	18,5	37	1,5	6	060,6	30183639
70,60-79,59	32	166,5	60	105	18,5	37	1,5	6	070,6	30183640
79,60-90,59	40	176,5	70	105	18,5	53,2	1,5	8	079,6	30183641
90,60-100,59	40	176,5	70	105	18,5	53,2	1,5	8	090,6	30183642

Required ordering designations

Holder	
Type	Size
e.g. MN73227	045,6



Cutting ring				
Type	ø	Tolerance	Cutting material	Lead angle
e.g. MN73217	45,75	H7	carbide	45°

Accessories
Page
180

Holder for cutting rings

Cylindrical shank, with internal coolant supply

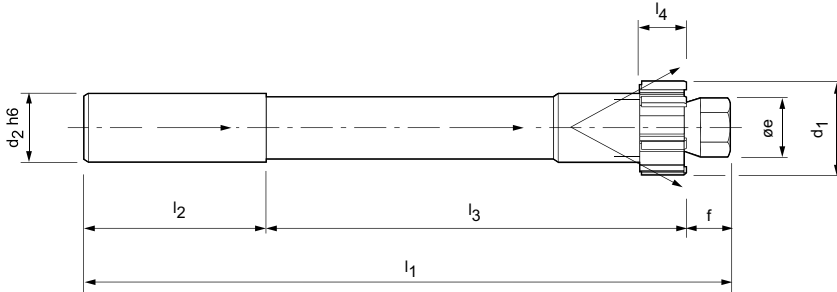

MN75247 - For through bore, short design

Dimensions								z	Size	Order No.
d ₁	d ₂ h6	l ₁	l ₂	l ₃	l ₄	øe	f			
21,60-25,59	20	142	50	81	11,5	11,5	11	6	021,6	30008872
25,60-32,59	20	163	50	102	13,5	15	11	6	025,6	30008873
32,60-36,59	25	172	56	102	15,5	21,9	14	6	032,6	30008874
36,60-40,59	25	172	56	102	15,5	21,9	14	6	036,6	30183644
40,60-45,59	25	173	56	102	15,5	21,9	15	6	040,6	30011658
45,60-50,59	32	185,5	60	105	18,5	30,3	20,5	6	045,6	30101615
50,60-60,59	32	185,5	60	105	18,5	30,3	20,5	6	050,6	30014625
60,60-70,59	32	189,5	60	105	18,5	40	24,5	6	060,6	30183645
70,60-79,59	32	189,5	60	105	18,5	40	24,5	6	070,6	30183646
79,60-90,59	40	203,5	70	105	18,5	56,2	28,5	8	079,6	30159444
90,60-100,59	40	203,5	70	105	18,5	56,2	28,5	8	090,6	30183647

Required ordering designations

Holder	
Type	Size
e.g. MN73227	045,6



Cutting ring				
Type	ø	Tolerance	Cutting material	Lead angle
e.g. MN73217	45,75	H7	carbide	45°

Accessories
Page
180

Holder for cutting rings

Morse taper shank, without internal coolant supply

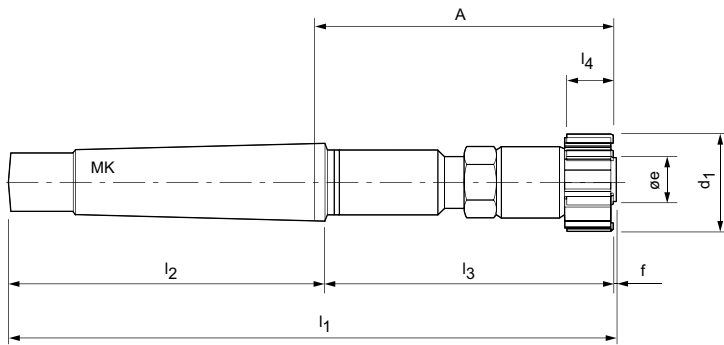

MN73217 - For through bore, short design

Dimensions									z	Size	Order No.
d ₁	MK	l ₁	l ₂	l ₃	l ₄	A	øe	f			
21,60-25,59	2	164	80	81	11,5	86	12	3	6	021,6	30183663
25,60-32,59	3	204,5	99	102	13,5	107	15,8	3,5	6	025,6	30032438
32,60-40,59	3	205,5	99	102	15,5	107,1	21,4	4,5	6	032,6	30183664
40,60-45,59	3	206	99	102	15,5	107,1	25,5	5	6	040,6	30183666
45,60-60,59	3	208	97	104	18,5	109	29,6	7	6	045,6	30018476
60,60-79,59	4	237	124	103	18,5	109	39,8	10	6	060,6	30183668
79,60-100,59	5	273,5	156	105	18,5	111,5	57	12,5	8	079,6	30183670

MN73218 - For through and blind bore, short design | Please notice øe and f

21,60-25,59	2	162,8	80	81,8	11,5	86	11,2	1	6	021,6	30183649
25,60-32,59	3	203	99	103	13,5	107	15,2	1	6	025,6	30183650
32,60-40,59	3	202,5	99	102,5	15,5	107,1	20,3	1	6	032,6	30183651
40,60-45,59	3	202	99	102	15,5	107,1	24,1	1	6	040,6	30183652
45,60-60,59	3	201,5	97	103	18,5	108	27,8	1,5	6	045,6	30183653
60,60-79,59	4	226,5	124	101	18,5	107,5	37	1,5	6	060,6	30183654
79,60-100,59	5	261,5	156	104	18,5	110,5	53,2	1,5	8	079,6	30183655

Required ordering designations

Holder		+	Cutting ring					Accessories
Type	Size		Type	ø	Tolerance	Cutting material	Lead angle	Page
e.g. MN73217	045,6		e.g. MN73101	45,75	H7	carbide	45°	180

Dimensions in mm.

Please note that the holder and cutting ring must be ordered separately.
The tools are supplied fully assembled and set to the nominal size.

Holder for cutting rings

Morse taper shank, without internal coolant supply

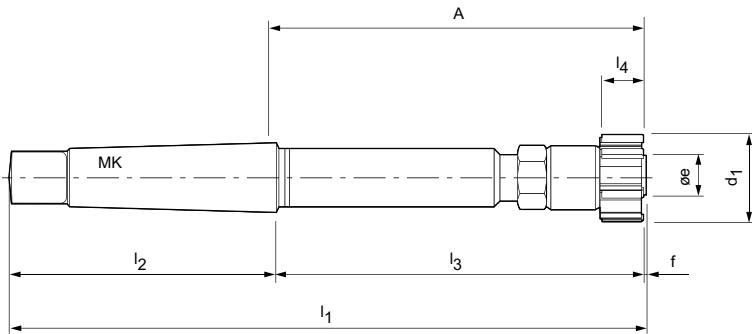

MN73227 - For through bore, long design

Dimensions									z	Size	Order No.
d ₁	MK	l ₁	l ₂	l ₃	l ₄	A	øe	f			
21,60-25,59	2	204	80	121	11,5	126	12	3	6	021,6	30183671
25,60-32,59	3	255,5	99	153	13,5	158	15,8	3,5	6	025,6	30183672
32,60-40,59	3	282,5	99	179	15,5	184	21,4	4,5	6	032,6	30011768
40,60-45,59	3	304	99	200	15,5	205	25,5	5	6	040,6	30183674
45,60-60,59	3	318	97	214	18,5	219	29,6	7	6	045,6	30183675
60,60-79,59	4	372	124	238	18,5	244,5	39,8	10	6	060,6	30183677
79,60-100,59	5	413,5	156	245	18,5	251,5	57	12,5	8	079,6	30183679

MN73228 - For through and blind bore, long design | Please notice øe and f

21,60-25,59	2	202,8	80	121,8	11,5	126	11,2	1	6	021,6	30032509
25,60-32,59	3	254	99	154	13,5	158	15,2	1	6	025,6	30183657
32,60-40,59	3	279,5	99	179,5	15,5	184	20,3	1	6	032,6	30009573
40,60-45,59	3	300	99	200	15,5	205	24,1	1	6	040,6	30183659
45,60-60,59	3	310,5	97	212	18,5	217	27,8	1,5	6	045,6	30046300
60,60-79,59	4	361,5	124	236	18,5	242,5	37	1,5	6	060,6	30159446
79,60-100,59	5	401,5	156	244	18,5	250,5	53,2	1,5	8	079,6	30159445

Required ordering designations

Holder		+	Cutting ring				
Type	Size		Type	ø	Tolerance	Cutting material	Lead angle
e.g. MN73227	045,6		e.g. MN73101	45,75	H7	carbide	45°

Dimensions in mm.

Please note that the holder and cutting ring must be ordered separately.
The tools are supplied fully assembled and set to the nominal size.

Holder for cutting rings

With radial and axial adjustment module connection, dimensions as per MN 5000-14, with internal coolant supply

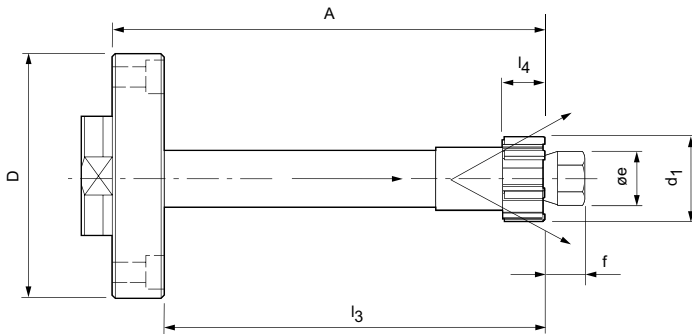

MN75287 - For through bore, short design

Dimensions							z	Size	Order No.
d ₁	D	l ₃	l ₄	A	øe	f			
21,60-25,59	60	81	11,5	94	11,5	11	6	021,6	30183584
25,60-32,59	60	102	13,5	115	15	11	6	025,6	30183586
32,60-36,59	60	102	15,5	115	21,9	14	6	032,6	30032760
36,60-40,59	60	102	15,5	115	21,9	14	6	036,6	30183588
40,60-45,59	60	102	15,5	115	25,4	15	6	040,6	30183600
45,60-50,59	60	105	18,5	118	30,3	20,5	6	045,6	30020589
50,60-60,59	60	105	18,5	118	30,3	20,5	6	050,6	30096638
60,60-70,59	100	105	18,5	126	40	24,5	6	060,6	30009234
70,60-79,59	100	105	18,5	126	40	24,5	6	070,6	30009236
79,60-90,59	100	105	18,5	126	56,2	28,5	8	079,6	30087508
90,60-100,59	100	105	18,5	126	56,2	28,5	8	090,6	30183602
100,60-110,59	100	106	18,5	127	73,4	35,5	10	100,6	30183605
110,60-115,59	100	136	18,5	157	90,4	35,5	12	110,6	30183607
115,60-120,59	100	136	18,5	157	90,4	35,5	12	115,6	30183608
120,60-125,59	100	136	18,5	157	90,4	35,5	12	120,6	30183609
125,60-132,59	100	136	18,5	157	90,4	35,5	12	125,6	30183610
132,60-139,59	100	136	18,5	157	90,4	35,5	12	132,6	30183611
139,60-145,59	100	136	18,5	157	d ₁ -12	35,5	12	139,6	30183612
145,60-155,59	100	136	18,5	157	d ₁ -12	35,5	12	145,6	30183613
155,60-165,59	100	136	18,5	157	d ₁ -12	48,5	12	155,6	30183614
165,60-175,59	100	136	18,5	157	d ₁ -12	48,5	12	165,6	30183615
175,60-185,59	100	136	18,5	157	d ₁ -12	48,5	12	175,6	30183616
185,60-195,59	100	136	18,5	157	d ₁ -12	48,5	12	185,6	30183617
195,60-200,59	100	136	18,5	157	d ₁ -12	48,5	12	195,6	30183618

Required ordering designations

Holder		+	Cutting ring					Accessories
Type	Size		Type	ø	Tolerance	Cutting material	Lead angle	Page
e.g. MN73227	045,6		e.g. MN73217	45,75	H7	carbide	45°	180

Dimensions in mm.

Please note that the holder and cutting ring must be ordered separately. The tools are supplied fully assembled and set to the nominal size.

Holder for cutting rings

With radial and axial adjustment module connection,
dimensions as per MN 5000-14, with internal coolant supply

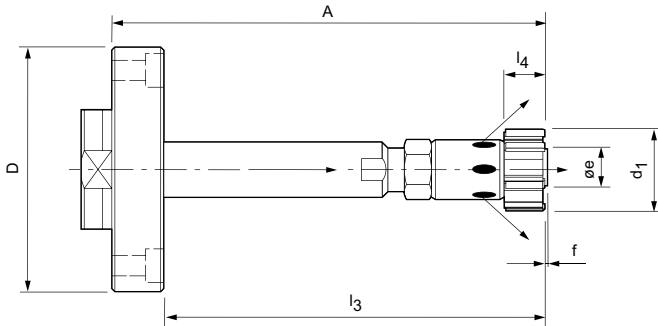

MN76286 - For blind bore, short design

Dimensions							z	Size	Order No.
d ₁	D	l ₃	l ₄	A	øe	f			
21,60-25,59	60	81	11,5	94	11,2	1	6	021,6	30183540
25,60-32,59	60	102	13,5	115	15,2	1	6	025,6	30183542
32,60-36,59	60	102	15,5	115	20,3	1,5	6	032,6	30183544
36,60-40,59	60	102	15,5	115	20,3	1,5	6	036,6	30183546
40,60-45,59	60	102	15,5	115	24,1	1,5	6	040,6	30183548
45,60-50,59	60	105	18,5	118	27,8	1,5	6	045,6	30183550
50,60-60,59	60	105	18,5	118	27,8	1,5	6	050,6	30183552
60,60-70,59	100	105	18,5	126	37	1,5	6	060,6	30183554
70,60-79,59	100	105	18,5	126	37	1,5	6	070,6	30183556
79,60-90,59	100	117	18,5	138	53,2	1,5	8	079,6	30183558
90,60-100,59	100	117	18,5	138	53,2	1,5	8	090,6	30183560

Required ordering designations

Holder	
Type	Size
e.g. MN73227	045,6



Cutting ring				
Type	ø	Tolerance	Cutting material	Lead angle
e.g. MN73217	45,75	H7	carbide	45°

Accessories
Page
180

Holder for cutting rings

With radial and axial adjustment module connection, dimensions as per MN 5000-14, with internal coolant supply

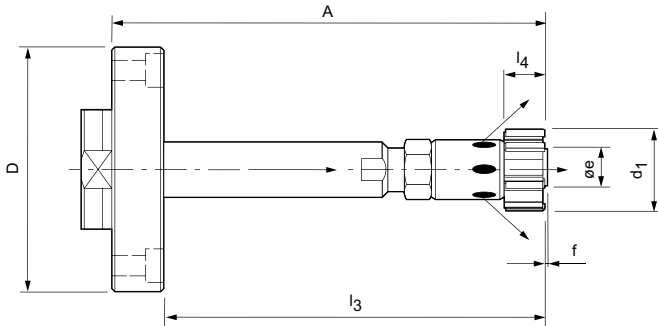

MN75286 - For through and blind bore, short design

Dimensions							z	Size	Order No.
d ₁	D	l ₃	l ₄	A	øe	f			
21,60-25,59	60	81	11,5	94	11,2	1	6	021,6	30183564
25,60-32,59	60	102	13,5	115	15,2	1	6	025,6	30183566
32,60-36,59	60	102	15,5	115	20,3	1,5	6	032,6	30183568
36,60-40,59	60	102	15,5	115	20,3	1,5	6	036,6	30183570
40,60-45,59	60	102	15,5	115	24,1	1,5	6	040,6	30183572
45,60-50,59	60	105	18,5	118	27,8	1,5	6	045,6	30183574
50,60-60,59	60	105	18,5	118	27,8	1,5	6	050,6	30018640
60,60-70,59	100	105	18,5	126	37	1,5	6	060,6	30018490
70,60-79,59	100	105	18,5	126	37	1,5	6	070,6	30183576
79,60-90,59	100	117	18,5	138	53,2	1,5	8	079,6	30183578
90,60-100,59	100	117	18,5	138	53,2	1,5	8	090,6	30183580

Required ordering designations

Holder		+	Cutting ring					Accessories	
Type	Size		Type	ø	Tolerance	Cutting material	Lead angle	Page	
e.g. MN73227	045,6		e.g. MN73217	45,75	H7	carbide	45°	180	

Dimensions in mm.

Please note that the holder and cutting ring must be ordered separately. The tools are supplied fully assembled and set to the nominal size.

Holder for cutting rings

Shank HSK-A in accordance to DIN 69893-A, with internal coolant supply

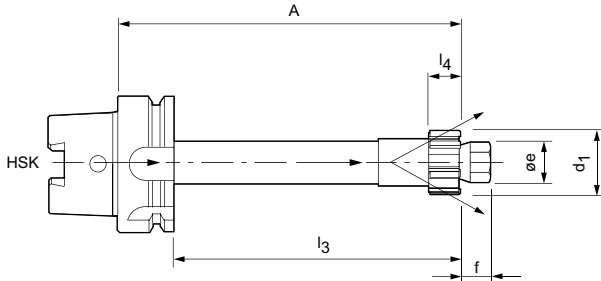

MN75257 - For through bore, short design

Dimensions							z	Size	Order No.
d ₁	HSK	l ₃	l ₄	A	øe	f			
21,60-25,59	63	81	11,5	107	11,5	11	6	021,6	30183334
25,60-32,59	63	102	13,5	128	15	11	6	025,6	30183335
32,60-36,59	63	102	15,5	128	21,9	14	6	032,6	30183336
36,60-40,59	63	102	15,5	128	21,9	14	6	036,6	30183337
40,60-45,59	63	102	15,5	128	25,4	15	6	040,6	30183338
45,60-50,59	63	105	18,5	131	30,3	20,5	6	045,6	30183339
50,60-60,59	63	105	18,5	131	30,3	20,5	6	050,6	30183340
60,60-70,59	63	105	18,5	131	40	24,5	6	060,6	30183341
70,60-79,59	63	105	18,5	131	40	24,5	6	070,6	30183342
79,60-90,59	63	105	18,5	131	56,2	28,5	8	079,6	30183343
90,60-100,59	63	105	18,5	131	56,2	28,5	8	090,6	30183344
100,60-110,59	63	106	18,5	132	73,4	35,5	10	100,6	30183345
110,60-115,59	63	136	18,5	162	90,4	35,5	12	110,6	30183346
115,60-120,59	63	136	18,5	162	90,4	35,5	12	115,6	30183347
120,60-125,59	63	136	18,5	162	90,4	35,5	12	120,6	30183348
125,60-132,59	63	136	18,5	162	90,4	35,5	12	125,6	30183349
132,60-139,59	63	136	18,5	162	90,4	35,5	12	132,6	30183350
139,60-145,59	63	136	18,5	162	d ₁ -12	35,5	12	139,6	30183351
145,60-155,59	63	136	18,5	162	d ₁ -12	35,5	12	145,6	30183352
155,60-165,59	63	136	18,5	162	d ₁ -12	48,5	12	155,6	30183353

Continued on next page.

MN75257 - For through bore, short design

Dimensions							z	Size	Order No.
d ₁	HSK	l ₃	l ₄	A	øe	f			
165,60-175,59	63	136	18,5	162	d ₁ -12	48,5	12	165,6	30183354
175,60-185,59	63	136	18,5	162	d ₁ -12	48,5	12	175,6	30183355
185,60-195,59	63	136	18,5	162	d ₁ -12	48,5	12	185,6	30183356
195,60-200,59	63	136	18,5	162	d ₁ -12	48,5	12	195,6	30183357
200,60-205,59	63	136	18,5	162	d ₁ -13	48,5	12	200,6	30183358
205,60-210,59	63	136	18,5	162	d ₁ -14	48,5	12	205,6	30183359
210,60-215,59	63	136	18,5	162	d ₁ -15	48,5	12	210,6	30183360
215,60-225,59	63	136	18,5	162	d ₁ -16	48,5	12	215,6	30183361
225,60-235,59	63	136	18,5	162	d ₁ -17	48,5	12	225,6	30183362
235,60-245,59	63	136	18,5	162	d ₁ -18	48,5	12	235,6	30183363
245,60-255,59	63	136	18,5	162	d ₁ -19	48,5	12	245,6	30183364
255,60-265,59	63	160	18,5	196	d ₁ -20	51,5	12	255,6	30183365
265,60-275,59	63	160	18,5	196	d ₁ -21	51,5	12	265,6	30183366
275,60-285,59	63	160	18,5	196	d ₁ -22	51,5	12	275,6	30183367
285,60-295,59	63	160	18,5	196	d ₁ -23	51,5	12	285,6	30183368
295,60-300,59	63	160	18,5	196	d ₁ -24	51,5	12	295,6	30183369

Required ordering designations

Holder		+	Cutting ring					Accessories
Type	Size		Type	ø	Tolerance	Cutting material	Lead angle	Page
e.g. MN73227	045,6		e.g. MN73217	45,75	H7	carbide	45°	180

Dimensions in mm.

Please note that the holder and cutting ring must be ordered separately.
The tools are supplied fully assembled and set to the nominal size.

Holder for cutting rings

Shank HSK-A in accordance to DIN 69893-A, with internal coolant supply

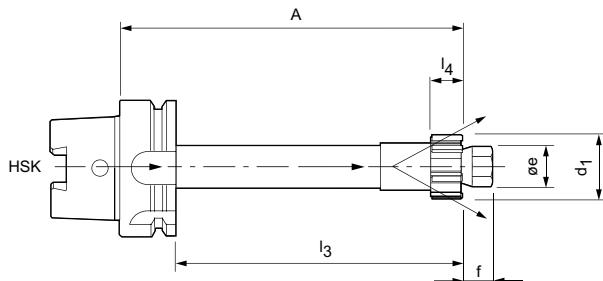

MN75267 - For through bore, long design

Dimensions							z	Size	Order No.
d ₁	HSK	l ₃	l ₄	A	øe	f			
21,60-25,59	63	121	11,5	147	11,5	11	6	021,6	30183383
25,60-32,59	63	153	13,5	179	15	11	6	025,6	30183384
32,60-36,59	63	179	15,5	205	21,9	14	6	032,6	30183385
36,60-40,59	63	179	15,5	205	21,9	14	6	036,6	30183386
40,60-45,59	63	201	15,5	227	25,4	15	6	040,6	30183387
45,60-50,59	63	214	18,5	240	30,3	20,5	6	045,6	30183388
50,60-60,59	63	214	18,5	240	30,3	20,5	6	050,6	30183389
60,60-70,59	63	237	18,5	263	40	24,5	6	060,6	30183390
70,60-79,59	63	237	18,5	263	40	24,5	6	070,6	30183391
79,60-90,59	63	245	18,5	271	56,2	28,5	8	079,6	30183392
90,60-100,59	63	245	18,5	271	56,2	28,5	8	090,6	30183393
100,60-110,59	63	245	18,5	271	73,4	35,5	10	100,6	30183394
110,60-115,59	63	245	18,5	271	90,4	35,5	12	110,6	30183395
115,60-120,59	63	245	18,5	271	90,4	35,5	12	115,6	30183396
120,60-125,59	63	245	18,5	271	90,4	35,5	12	120,6	30183397
125,60-132,59	63	245	18,5	271	90,4	35,5	12	125,6	30183398
132,60-139,59	63	245	18,5	271	90,4	35,5	12	132,6	30183399
139,60-145,59	63	245	18,5	271	d ₁ -12	35,5	12	139,6	30183400
145,60-155,59	63	245	18,5	271	d ₁ -12	35,5	12	145,6	30183401
155,60-165,59	63	245	18,5	271	d ₁ -12	48,5	12	155,6	30183402

Continued on next page.

MN75267 - For through bore, long design

Dimensions							z	Size	Order No.
d ₁	HSK	l ₃	l ₄	A	øe	f			
165,60-175,59	63	245	18,5	271	d ₁ -12	48,5	12	165,6	30183403
175,60-185,59	63	245	18,5	271	d ₁ -12	48,5	12	175,6	30183404
185,60-195,59	63	245	18,5	271	d ₁ -12	48,5	12	185,6	30183405
195,60-200,59	63	245	18,5	271	d ₁ -12	48,5	12	195,6	30183406
200,60-205,59	63	245	18,5	271	d ₁ -12	48,5	12	200,6	30183407
205,60-210,59	63	245	18,5	271	d ₁ -12	48,5	12	205,6	30183408
210,60-215,59	63	245	18,5	271	d ₁ -12	48,5	12	210,6	30183409
215,60-225,59	63	245	18,5	271	d ₁ -12	48,5	12	215,6	30183410
225,60-235,59	63	245	18,5	271	d ₁ -12	48,5	12	225,6	30183411
235,60-245,59	63	245	18,5	271	d ₁ -12	48,5	12	235,6	30183412
245,60-255,59	63	245	18,5	271	d ₁ -12	48,5	12	245,6	30183413
255,60-265,59	63	245	18,5	271	d ₁ -12	51,5	12	255,6	30183414
265,60-275,59	63	245	18,5	271	d ₁ -12	51,5	12	265,6	30183415
275,60-285,59	63	245	18,5	271	d ₁ -12	51,5	12	275,6	30183416
285,60-295,59	63	245	18,5	271	d ₁ -12	51,5	12	285,6	30183417
295,60-300,59	63	245	18,5	271	d ₁ -12	51,5	12	295,6	30183418

Required ordering designations

Holder		+	Cutting ring					Accessories
Type	Size		Type	ø	Tolerance	Cutting material	Lead angle	Page
e.g. MN73227	045,6		e.g. MN73217	45,75	H7	carbide	45°	180

Dimensions in mm.

Please note that the holder and cutting ring must be ordered separately.
The tools are supplied fully assembled and set to the nominal size.

Holder for cutting rings

Shank HSK-A in accordance to DIN 69893-A, with internal coolant supply

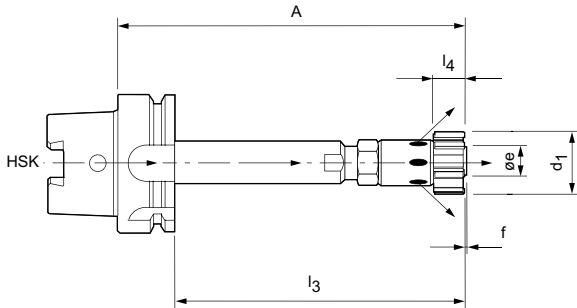

MN75256 - For through and blind bore, short design

Dimensions							z	Size	Order No.
d ₁	HSK	l ₃	l ₄	A	øe	f			
21,60-25,59	50	81	11,5	107	11,2	1	6	021,6	30183322
25,60-32,59	50	102	13,5	128	15,2	1	6	025,6	30183323
32,60-36,59	50	102	15,5	128	20,3	1,5	6	032,6	30183324
36,60-40,59	50	102	15,5	128	20,3	1,5	6	036,6	30183325
40,60-45,59	50	102	15,5	128	24,1	1,5	6	040,6	30183326
45,60-50,59	50	105	18,5	131	27,8	1,5	6	045,6	30183327
50,60-60,59	50	105	18,5	131	27,8	1,5	6	050,6	30183328
60,60-70,59	63	105	18,5	131	37	1,5	6	060,6	30183329
70,60-79,59	63	105	18,5	131	37	1,5	6	070,6	30183330
79,60-90,59	63	117	18,5	143	53,2	1,5	8	079,6	30183331
90,60-100,59	63	117	18,5	143	53,2	1,5	8	090,6	30183332

MN75266 - For through and blind bore, long design

21,60-25,59	50	121	11,5	147	11,2	1	6	021,6	30183371
25,60-32,59	50	153	13,5	179	15,2	1	6	025,6	30183372
32,60-36,59	50	179	15,5	205	20,3	1,5	6	032,6	30183373
36,60-40,59	50	179	15,5	205	20,3	1,5	6	036,6	30183374
40,60-45,59	50	200	15,5	226	24,1	1,5	6	040,6	30183375
45,60-50,59	50	214	18,5	240	27,8	1,5	6	045,6	30183376
50,60-60,59	50	214	18,5	240	27,8	1,5	6	050,6	30183377
60,60-70,59	63	237	18,5	263	37	1,5	6	060,6	30183378
70,60-79,59	63	237	18,5	263	37	1,5	6	070,6	30183379
79,60-90,59	63	245	18,5	271	53,2	1,5	8	079,6	30183380
90,60-100,59	63	245	18,5	271	53,2	1,5	8	090,6	30183381

Required ordering designations

Holder	
Type	Size
e.g. MN73227	045,6



Cutting ring				
Type	ø	Tolerance	Cutting material	Lead angle
e.g. MN73217	45,75	H7	carbide	45°

Accessories
Page
180

Holder for cutting rings

Shank HSK-A in accordance to DIN 69893-A, with internal coolant supply

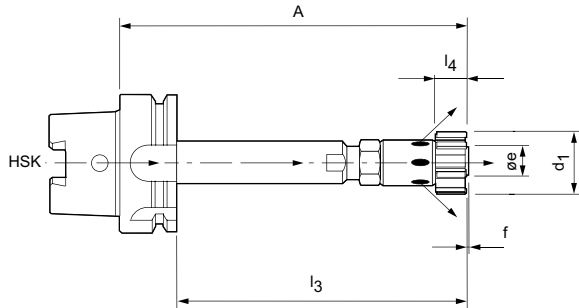

MN76256 - For blind bore, short design

Dimensions							z	Size	Order No.
d ₁	HSK	l ₃	l ₄	A	øe	f			
21,60-25,59	50	81	11,5	107	11,2	1	6	021,6	30183299
25,60-32,59	50	102	13,5	128	15,2	1	6	025,6	30183300
32,60-36,59	50	102	15,5	128	20,3	1,5	6	032,6	30183301
36,60-40,59	50	102	15,5	128	20,3	1,5	6	036,6	30183302
40,60-45,59	50	102	15,5	128	24,1	1,5	6	040,6	30183303
45,60-50,59	50	105	18,5	131	27,8	1,5	6	045,6	30183304
50,60-60,59	50	105	18,5	131	27,8	1,5	6	050,6	30183305
60,60-70,59	63	105	18,5	131	37	1,5	6	060,6	30183306
70,60-79,59	63	105	18,5	131	37	1,5	6	070,6	30244049
79,60-90,59	63	117	18,5	143	53,2	1,5	8	079,6	30183307
90,60-100,59	63	117	18,5	143	53,2	1,5	8	090,6	30183308

MN76266 - For blind bore, long design

21,60-25,59	50	121	11,5	147	11,2	1	6	021,6	30183310
25,60-32,59	50	153	13,5	179	15,2	1	6	025,6	30183311
32,60-36,59	50	179	15,5	205	20,3	1,5	6	032,6	30183312
36,60-40,59	50	179	15,5	205	20,3	1,5	6	036,6	30183313
40,60-45,59	50	200	15,5	226	24,1	1,5	6	040,6	30183314
45,60-50,59	50	214	18,5	240	27,8	1,5	6	045,6	30183315
50,60-60,59	50	214	18,5	240	27,8	1,5	6	050,6	30183316
60,60-70,59	63	237	18,5	263	37	1,5	6	060,6	30183317
70,60-79,59	63	237	18,5	263	37	1,5	6	070,6	30183318
79,60-90,59	63	245	18,5	271	53,2	1,5	8	079,6	30183319
90,60-100,59	63	245	18,5	271	53,2	1,5	8	090,6	30183320

Required ordering designations

Holder		+	Cutting ring					Accessories	
Type	Size		Type	ø	Tolerance	Cutting material	Lead angle	Page	
e.g. MN73227	045,6		e.g. MN73217	45,75	H7	carbide	45°	180	

Dimensions in mm.

Please note that the holder and cutting ring must be ordered separately.
The tools are supplied fully assembled and set to the nominal size.

Holder for cutting rings

Morse taper shank | Shank SK in accordance to ISO 7388-1 Form AD/AF,
with internal coolant supply

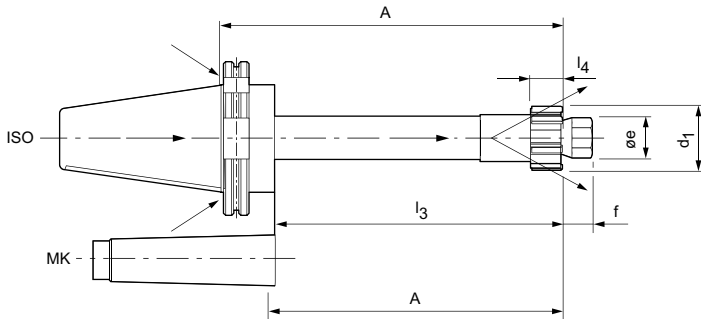

MN75217 - For through bore, short design

Dimensions								z	Size	Order No.
d ₁	MK	SK	l ₃	l ₄	A	øe	f			
21,60-25,59	2	-	81	11,5	86	11,5	11	6	021,6	30183484
25,60-32,59	3	-	102	13,5	107	15	11	6	025,6	30183485
32,60-36,59	3	-	102	15,5	107	21,9	14	6	032,6	30183486
36,60-40,59	3	-	102	15,5	107	21,9	14	6	036,6	30082419
40,60-45,59	3	-	102	15,5	107	25,4	15	6	040,6	30183487
45,60-50,59	4	-	105	18,5	111,5	30,3	20,5	6	045,6	30183488
50,60-60,59	4	-	105	18,5	111,5	30,3	20,5	6	050,6	30082417
60,60-70,59	-	50	105	18,5	143,1	40,0	24,5	6	060,6	30057566
70,60-79,59	-	50	105	18,5	143,1	40,0	24,5	6	070,6	30183489
79,60-90,59	-	50	105	18,5	124,1	56,2	28,5	8	079,6	30183490
90,60-100,59	-	50	105	18,5	124,1	56,2	28,5	8	090,6	30077763
100,60-110,59	-	50	106	18,5	125,1	73,4	35,5	10	100,6	30183491
110,60-115,59	-	50	136	18,5	155,1	90,4	35,5	12	110,6	30058626
115,60-120,59	-	50	136	18,5	155,1	90,4	35,5	12	115,6	30076909
120,60-125,59	-	50	136	18,5	155,1	90,4	35,5	12	120,6	30183492
125,60-132,59	-	50	136	18,5	155,1	90,4	35,5	12	125,6	30183493
132,60-139,59	-	50	136	18,5	155,1	90,4	35,5	12	132,6	30183494
139,60-145,59	-	50	136	18,5	155,1	d ₁ -12	35,5	12	139,6	30183495
145,60-155,59	-	50	136	18,5	155,1	d ₁ -12	35,5	12	145,6	30058627
155,60-165,59	-	50	136	18,5	155,1	d ₁ -12	48,5	12	155,6	30077764

Continued on next page.

MN75217 - For through bore, short design

Dimensions								z	Size	Order No.
d ₁	MK	SK	l ₃	l ₄	A	øe	f			
165,60-175,59	-	50	136	18,5	155,1	d ₁ -12	48,5	12	165,6	30183496
175,60-185,59	-	50	136	18,5	155,1	d ₁ -12	48,5	12	175,6	30183497
185,60-195,59	-	50	136	18,5	155,1	d ₁ -12	48,5	12	185,6	30243815
195,60-200,59	-	50	136	18,5	155,1	d ₁ -12	48,5	12	195,6	30183498
200,60-205,59	-	50	136	18,5	155,1	d ₁ -12	48,5	12	200,6	30077765
205,60-210,59	-	50	136	18,5	155,1	d ₁ -12	48,5	12	205,6	30183499
210,60-215,59	-	50	136	18,5	155,1	d ₁ -12	48,5	12	210,6	30183500
215,60-225,59	-	50	136	18,5	155,1	d ₁ -12	48,5	12	215,6	30183501
225,60-235,59	-	50	136	18,5	155,1	d ₁ -12	48,5	12	225,6	30183502
235,60-245,59	-	50	136	18,5	155,1	d ₁ -12	48,5	12	235,6	30183503
245,60-255,59	-	50	136	18,5	155,1	d ₁ -12	48,5	12	245,6	30183504
255,60-265,59	-	50	160	18,5	179,1	d ₁ -12	51,5	12	255,6	30183505
265,60-275,59	-	50	160	18,5	179,1	d ₁ -12	51,5	12	265,6	30183506
275,60-285,59	-	50	160	18,5	179,1	d ₁ -12	51,5	12	275,6	30183507
285,60-295,59	-	50	160	18,5	179,1	d ₁ -12	51,5	12	285,6	30183508
295,60-300,59	-	50	160	18,5	179,1	d ₁ -12	51,5	12	295,6	30183509

Required ordering designations

Holder		+	Cutting ring					Accessories
Type	Size		Type	ø	Tolerance	Cutting material	Lead angle	Page
e.g. MN73227	045,6		e.g. MN73217	45,75	H7	carbide	45°	180

Dimensions in mm.

Please note that the holder and cutting ring must be ordered separately.
The tools are supplied fully assembled and set to the nominal size.

Holder for cutting rings

Morse taper shank | Shank SK in accordance to ISO 7388-1 Form AD/AF,
with internal coolant supply

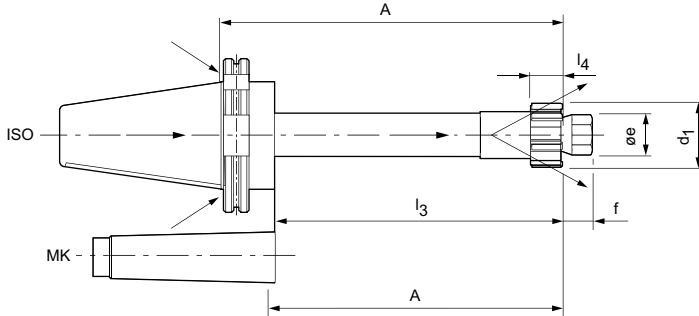

MN75227 - For through bore, long design

Dimensions								z	Size	Order No.
d ₁	MK	SK	l ₃	l ₄	A	øe	f			
21,60-25,59	2	-	121	11,5	126	11,5	11	6	021,6	30183525
25,60-32,59	3	-	153	13,5	158	15	11	6	025,6	30183527
32,60-36,59	3	-	179	15,5	184	21,9	14	6	032,6	30183529
36,60-40,59	3	-	179	15,5	184	21,9	14	6	036,6	30183530
40,60-45,59	3	-	201	15,5	206	25,4	15	6	040,6	30183532
45,60-50,59	4	-	214	18,5	220,5	30,3	20,5	6	045,6	30183535
50,60-60,59	4	-	214	18,5	220,5	30,3	20,5	6	050,6	30183536
60,60-70,59	-	50	237	18,5	275,1	40	24,5	6	060,6	30183422
70,60-79,59	-	50	237	18,5	275,1	40	24,5	6	070,6	30183423
79,60-90,59	-	50	245	18,5	264,1	56,2	28,5	8	079,6	30183424
90,60-100,59	-	50	245	18,5	264,1	56,2	28,5	8	090,6	30183425
100,60-110,59	-	50	245	18,5	264,1	73,4	35,5	10	100,6	30183426
110,60-115,59	-	50	245	18,5	264,1	90,4	35,5	12	110,6	30183427
115,60-120,59	-	50	245	18,5	264,1	90,4	35,5	12	115,6	30033907
120,60-125,59	-	50	245	18,5	264,1	90,4	35,5	12	120,6	30183428
125,60-132,59	-	50	245	18,5	264,1	90,4	35,5	12	125,6	30183429
132,60-139,59	-	50	245	18,5	264,1	90,4	35,5	12	132,6	30183430
139,60-145,59	-	50	245	18,5	264,1	d ₁ -12	35,5	12	139,6	30183431
145,60-155,59	-	50	245	18,5	264,1	d ₁ -12	35,5	12	145,6	30183432
155,60-165,59	-	50	245	18,5	264,1	d ₁ -12	48,5	12	155,6	30183433

Continued on next page.

MN75227 - For through bore, long design

Dimensions								z	Size	Order No.
d ₁	MK	SK	l ₃	l ₄	A	øe	f			
165,60-175,59	-	50	245	18,5	264,1	d ₁ -12	48,5	12	165,6	30183434
175,60-185,59	-	50	245	18,5	264,1	d ₁ -12	48,5	12	175,6	30183435
185,60-195,59	-	50	245	18,5	264,1	d ₁ -12	48,5	12	185,6	30183436
195,60-200,59	-	50	245	18,5	264,1	d ₁ -12	48,5	12	195,6	30183437
200,60-205,59	-	50	245	18,5	264,1	d ₁ -12	48,5	12	200,6	30183438
205,60-210,59	-	50	245	18,5	264,1	d ₁ -12	48,5	12	205,6	30183439
210,60-215,59	-	50	245	18,5	264,1	d ₁ -12	48,5	12	210,6	30183440
215,60-225,59	-	50	245	18,5	264,1	d ₁ -12	48,5	12	215,6	30183441
225,60-235,59	-	50	245	18,5	264,1	d ₁ -12	48,5	12	225,6	30183442
235,60-245,59	-	50	245	18,5	264,1	d ₁ -12	48,5	12	235,6	30183443
245,60-255,59	-	50	245	18,5	264,1	d ₁ -12	48,5	12	245,6	30183444
255,60-265,59	-	50	245	18,5	264,1	d ₁ -12	51,5	12	255,6	30183445
265,60-275,59	-	50	245	18,5	264,1	d ₁ -12	51,5	12	265,6	30183446
275,60-285,59	-	50	245	18,5	264,1	d ₁ -12	51,5	12	275,6	30183447
285,60-295,59	-	50	245	18,5	264,1	d ₁ -12	51,5	12	285,6	30183448
295,60-300,59	-	50	245	18,5	264,1	d ₁ -12	51,5	12	295,6	30183449

Required ordering designations

Holder		+	Cutting ring					Accessories
Type	Size		Type	ø	Tolerance	Cutting material	Lead angle	Page
e.g. MN73227	045,6		e.g. MN73217	45,75	H7	carbide	45°	180

Dimensions in mm.

Please note that the holder and cutting ring must be ordered separately.
The tools are supplied fully assembled and set to the nominal size.

Holder for cutting rings

Morse taper shank | Shank SK in accordance to ISO 7388-1 Form AD/AF with internal coolant supply

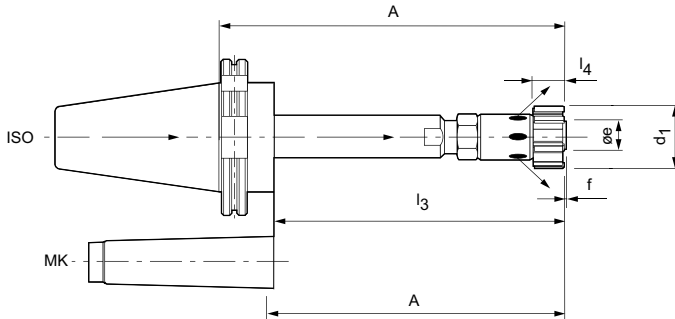

MN76216 - For blind bore, short design

Dimensions								z	Size	Order No.
d ₁	MK	SK	l ₃	l ₄	A	øe	f			
21,60-25,59	2	-	81	11,5	86	11,2	1	6	021,6	30183451
25,60-32,59	3	-	102	13,5	107	15,2	1	6	025,6	30183452
32,60-36,59	3	-	102	15,5	107	20,3	1,5	6	032,6	30183453
36,60-40,59	3	-	102	15,5	107	20,3	1,5	6	036,6	30183454
40,60-45,59	3	-	102	15,5	107	24,1	1,5	6	040,6	30183455
45,60-50,59	4	-	105	18,5	111,5	27,8	1,5	6	045,6	30183456
50,60-60,59	4	-	105	18,5	111,5	27,8	1,5	6	050,6	30183457
60,60-70,59	-	50	105	18,5	143,1	37	1,5	6	060,6	30183458
70,60-79,59	-	50	107	18,5	143,1	37	1,5	6	070,6	30183459
79,60-90,59	-	50	117	18,5	136,1	53,2	1,5	8	079,6	30183460
90,60-100,59	-	50	117	18,5	136,1	53,2	1,5	8	090,6	30183461

MN76226 - For blind bore, long design

21,60-25,59	2	-	121	11,5	126	11,2	1	6	021,6	30183463
25,60-32,59	3	-	153	13,5	158	15,2	1	6	025,6	30183464
32,60-36,59	3	-	179	15,5	184	20,3	1,5	6	032,6	30183465
36,60-40,59	3	-	179	15,5	184	20,3	1,5	6	036,6	30183466
40,60-45,59	3	-	200	15,5	205	24,1	1,5	6	040,6	30183467
45,60-50,59	4	-	214	18,5	220,5	27,8	1,5	6	045,6	30183468
50,60-60,59	4	-	214	18,5	220,5	27,8	1,5	6	050,6	30206526
60,60-70,59	-	50	237	18,5	275,1	37	1,5	6	060,6	30183469
70,60-79,59	-	50	239	18,5	275,1	37	1,5	6	070,6	30243944
79,60-90,59	-	50	245	18,5	264,1	53,2	1,5	8	079,6	30183470
90,60-100,59	-	50	245	18,5	264,1	53,2	1,5	8	090,6	30183471

Required ordering designations

Holder	
Type	Size
e.g. MN73227	045,6



Cutting ring				
Type	ø	Tolerance	Cutting material	Lead angle
e.g. MN73217	45,75	H7	carbide	45°

Accessories
Page
180

Holder for cutting rings

Morse taper shank | Shank SK in accordance to ISO 7388-1 Form AD/AF with internal coolant supply

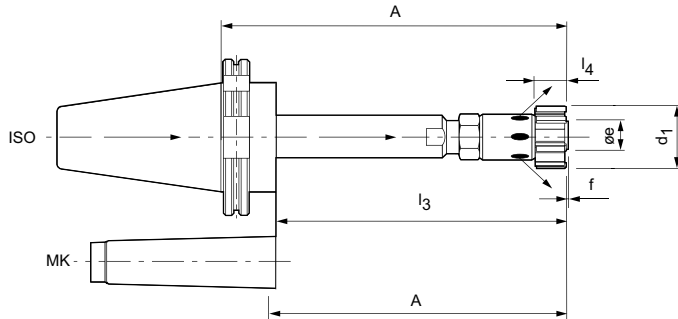

MN75216 - For through and blind bore, short design

Dimensions								z	Size	Order No.
d ₁	MK	SK	l ₃	l ₄	A	øe	f			
21,60-25,59	2	-	81	11,5	86	11,2	1	6	021,6	30183473
25,60-32,59	3	-	102	13,5	107	15,2	1	6	025,6	30183474
32,60-36,59	3	-	102	15,5	107	20,3	1,5	6	032,6	30183475
36,60-40,59	3	-	102	15,5	107	20,3	1,5	6	036,6	30183476
40,60-45,59	3	-	102	15,5	107	24,1	1,5	6	040,6	30183477
45,60-50,59	4	-	105	18,5	111,5	27,8	1,5	6	045,6	30183478
50,60-60,59	4	-	105	18,5	111,5	27,8	1,5	6	050,6	30183479
60,60-70,59	-	50	105	18,5	143,1	37	1,5	6	060,6	30036894
70,60-79,59	-	50	107	18,5	143,1	37	1,5	6	070,6	30183480
79,60-90,59	-	50	117	18,5	136,1	53,2	1,5	8	079,6	30183481
90,60-100,59	-	50	117	18,5	136,1	53,2	1,5	8	090,6	30183482

MN75226 - For through and blind bore, long design

21,60-25,59	2	-	121	11,5	126	11,2	1	6	021,6	30183511
25,60-32,59	3	-	153	13,5	158	15,2	1	6	025,6	30183512
32,60-36,59	3	-	179	15,5	184	20,3	1,5	6	032,6	30183513
36,60-40,59	3	-	179	15,5	184	20,3	1,5	6	036,6	30183514
40,60-45,59	3	-	200	15,5	205	24,1	1,5	6	040,6	30183516
45,60-50,59	4	-	214	18,5	220,5	27,8	1,5	6	045,6	30183518
50,60-60,59	4	-	214	18,5	220,5	27,8	1,5	6	050,6	30183520
60,60-70,59	-	50	237	18,5	275,1	37	1,5	6	060,6	30092179
70,60-79,59	-	50	239	18,5	275,1	37	1,5	6	070,6	30183419
79,60-90,59	-	50	245	18,5	264,1	53,2	1,5	8	079,6	30183420
90,60-100,59	-	50	245	18,5	264,1	53,2	1,5	8	090,6	30183421

Required ordering designations

Holder		+	Cutting ring					Accessories
Type	Size		Type	ø	Tolerance	Cutting material	Lead angle	Page
e.g. MN73227	045,6		e.g. MN73217	45,75	H7	carbide	45°	180

Accessories

For cutting ring holders

For Type:
 MN75217, MN75227
 MN75257, MN75267
 MN75247
 MN75287

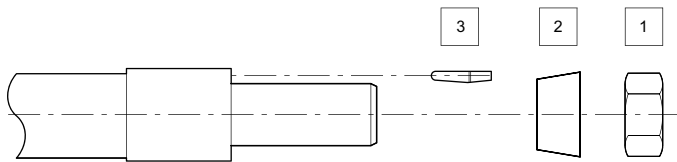

d ₁	1 Adjusting nut Order No.	2 Adjusting sleeve Order No.	3 Locking pin Order No.
21,60-25,59	10045282	10045293	10045321
25,60-32,59	10045285	10045294	10045322
32,60-36,59	10045286	10045295	10045323
36,60-40,59	10045286	10045295	10045323
40,60-45,59	10045287	10045296	10045324
45,60-50,59	10045288	10045297	10045325
50,60-60,59	10045288	10045297	10045325
60,60-70,59	10045289	10045298	10045326
70,60-79,59	10045289	10045298	10045326
79,60-90,59	10045290	10045299	10045327
90,60-100,59	10045290	10045299	10045327
100,60-110,59	10045291	10045300	10045327
110,60-115,59	10045291	10045301	10045327
115,60-120,59	10045291	10045302	10045327
120,60-125,59	10045291	10045302	10045327
125,60-132,59	10045291	10045303	10045328
132,60-139,59	10045291	10045303	10045328
139,60-145,59	10045291	10045304	10045328
145,60-155,59	10045291	10045305	10045329
155,60-165,59	10045292	10045306	10045329
165,60-175,59	10045292	10045307	10045329
175,60-185,59	10045292	10045308	10045329
185,60-195,59	10045292	10045309	10045329
195,60-200,59	10045292	10045310	10045329
200,60-205,59	10045292	10045310	10045329
205,60-210,59	10045292	10045311	10045329
210,60-215,59	10045292	10045311	10045329
215,60-225,59	10045292	10045312	10045329
225,60-235,59	10045292	10045313	10045329
235,60-245,59	10045292	10045314	10045329
245,60-255,59	10045292	10045315	10045329
255,60-265,59	50037875	10045316	10045329
265,60-275,59	50037875	10045317	10045329
275,60-285,59	50037875	10045318	10045329
285,60-295,59	50037875	10045319	10045329
295,60-300,59	50037875	10045320	10045329

Accessories

For cutting ring holders

For Type:
 MN73227, MN73228
 MN73237, MN73238
 MN73217, MN73218

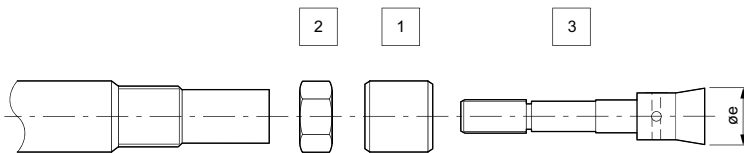

Sleeve and adjusting nut for $\varnothing 21,60 - \varnothing 45,59$

d_1	1 Sleeve Order No.	2 Adjusting nut Order No.
21,60-25,59	10045332	10045392
25,60-32,59	10045333	10045393
32,60-36,59	10045334	10045394
36,60-40,59	50034482	10045394
40,60-45,59	10045335	10045395

3 | Taper screw

d_1	Through bore Order No.	Blind bore $\varnothing e$ Order No.
21,60-25,59	10045342	10045347
25,60-32,59	10045343	10045348
32,60-36,59	10045344	10045349
36,60-40,59	10045344	10045349
40,60-45,59	10045345	10045350

3 | Taper screw - blind bore after repair

d_1	$\varnothing e + 1,2$ Order No.	$\varnothing e + 2,4$ Order No.
21,60-25,59	10045352	10045357
25,60-32,59	10045353	10045358
32,60-36,59	10045354	10045359
36,60-40,59	10045354	10045359
40,60-45,59	10045355	10045360

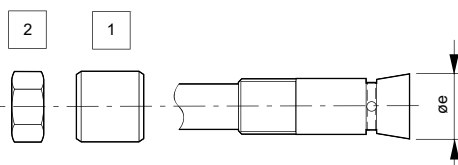

Sleeve and adjusting nut for $\varnothing 45,60 - \varnothing 100,59$

d_1	1 Sleeve Order No.	2 Adjusting nut Order No.
45,60-60,59	10045361	10045364
60,60-79,59	10045362	10045365
79,60-100,59	10045363	10045366

Dimensions in mm.

Accessories

For cutting ring holders

For Type:

MN75216, MN75226
 MN76216, MN76226
 MN75256, MN75266
 MN76256, MN76266
 MN75236, MN76236
 MN76286, MN75286

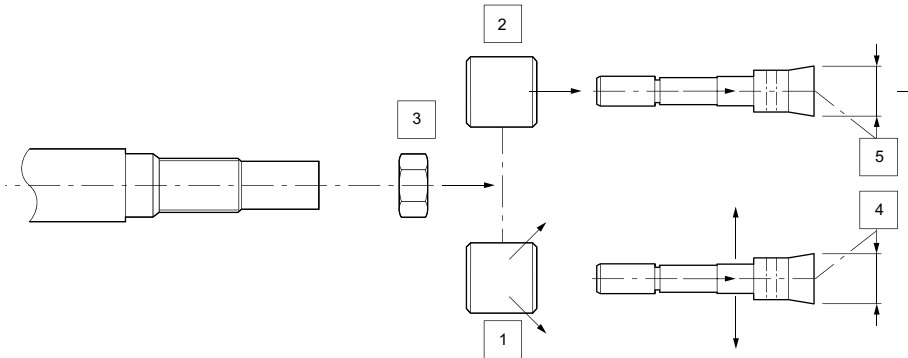

Sleeve and adjusting nut for $\varnothing 21,60 - \varnothing 100,59$

d_1	1 Sleeve with coolant outlet Order No.	2 Sleeve Order No.	3 Adjusting nut Order No.
21,60-25,59	10045368	50034483	10045392
25,60-32,59	10045369	50034484	10045393
32,60-36,59	10045370	50034485	10045394
36,60-40,59	10045371	-	-
40,60-45,59	10045372	50034486	10045395
45,60-50,59	10045373	50034487	10045364
50,60-60,59	10045374	50034488	10045364
60,60-70,59	10045375	50034489	50034493
70,60-79,59	10045376	50034490	50034493
79,60-90,59	10045377	50034491	50034494
90,60-100,59	10045378	50034492	50034494

4 | Taper screw with coolant outlet

d_1	Order No.	Repair e + 1,2 Order No.	Repair e + 2,4 Order No.
21,60-25,59	10045400	10045408	10045416
25,60-32,59	10045401	10045409	10045417
32,60-40,59	10045402	10045410	10045418
40,60-45,59	10045403	10045411	10045419
45,60-60,59	10045404	10045412	10045420
60,60-79,59	10045405	10045413	10045421
79,60-100,59	10045406	10045414	10045422

5 | Taper screw with central coolant supply

d_1	Order No.	Repair $\varnothing e + 1,2$ Order No.	Repair $\varnothing e + 2,4$ Order No.
21,60-25,59	50034536	10045432	10045440
25,60-32,59	50034537	10045433	10045441
32,60-40,59	50034538	10045434	10045442
40,60-45,59	50034539	10045435	10045443
45,60-60,59	50034540	10045436	10045444
60,60-79,59	50034541	10045437	10045445
79,60-100,59	50034542	10045438	10045446

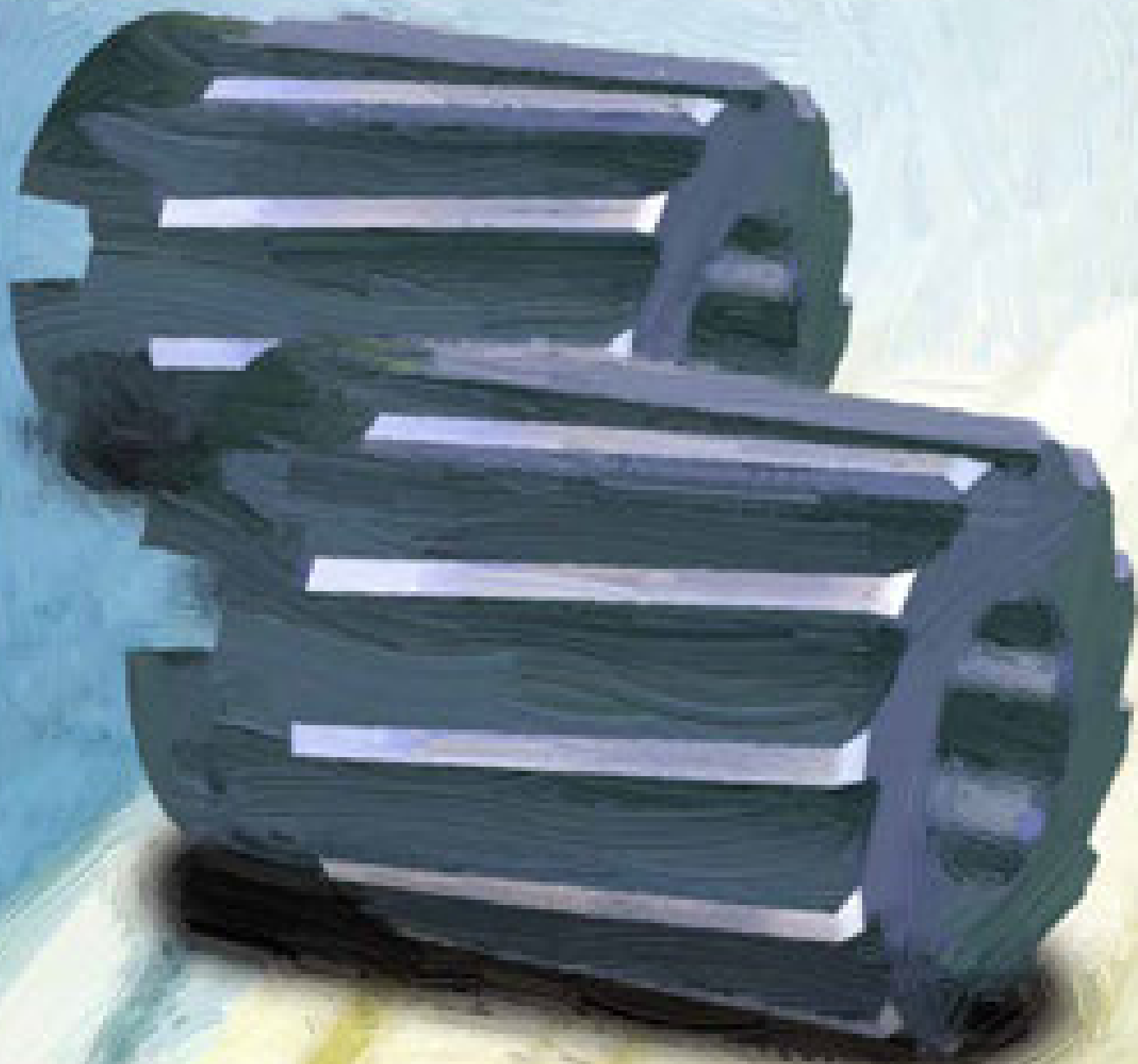



SHELL REAMERS

Shell reamers without internal coolant

DIN 8054, Form A, carbide	040910 _____	186
DIN 219, Form B, HSS-E	031211 _____	188
DIN 219, Form C, HSS-E	031310 _____	191

Holder for shell reamers

Holder DIN 217	031610 _____	193
Holder DIN 217	031611 _____	193
Holder DIN 217	031612 _____	193

Shell reamer | 040910

Preferred series, with brazed blades

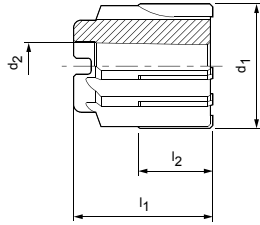

Design:

Diameter:
Cutting direction:
Cutting material:
Flute direction:

25,00-75,00 mm
Right-hand cutting
Carbide, uncoated
Straight fluted

Special feature:

Locating bore with
1:30 taper and driving
slot acc. to DIN 138



Dimensions				z	Order No.
d ₁ H7	d ₂	l ₁	l ₂		
25,00	13	45	25	6	30110217
26,00	13	45	25	6	30168898
28,00	13	45	25	6	30200123
30,00	13	45	30	8	30110218
31,00	13	45	30	8	30264144
32,00	13	45	30	8	30110219
33,00	13	45	30	8	30271654
34,00	13	45	30	8	30110220
35,00	13	45	30	8	30110221
36,00	16	50	30	8	30110222
37,00	16	50	30	8	30110223
38,00	16	50	30	8	30110224
40,00	16	50	30	8	30110225
41,00	16	50	30	8	30284755
42,00	16	50	30	8	30110226
43,00	16	50	30	8	30250677
44,00	16	50	30	8	30110227
45,00	16	50	30	8	30110228
46,00	19	56	30	10	30263750
47,00	19	56	30	10	30241053
48,00	19	56	30	10	30110229
50,00	19	56	30	10	30110230
52,00	19	56	30	10	30110231
55,00	22	63	30	10	30110232
58,00	22	63	30	10	30110233
60,00	22	63	30	10	30110234
62,00	22	63	30	10	30217739
65,00	27	71	30	12	30205920
70,00	27	71	30	12	30110236
72,00	27	71	30	12	30110237
75,00	27	71	30	12	30110238

Dimensions in mm.

d_2 = nominal diameter d_1 of suitable holder!

Cutting data see page 367 ff.

Shell reamer I 040910

Configurable series, with brazed blades

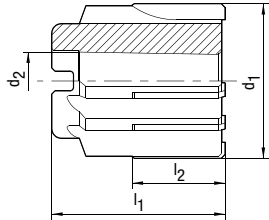

Design:

Diameter: 24,800-75,200 mm
 Cutting direction: Right-hand cutting
 Cutting material: Carbide, uncoated
 Flute direction: Straight fluted

Special feature:

Locating bore with 1:30 taper and driving slot acc. to DIN 138



Dimensions *				z
d ₁	d ₂	l ₁	l ₂	
24,800-26,200	13	45	25	6
26,500-28,200	13	45	25	6
29,500-32,200	13	45	30	8
32,500-35,200	13	45	30	8
35,500-38,200	16	50	30	8
39,500-42,200	16	50	30	8
42,500-45,200	16	50	30	8
45,500-48,200	19	56	30	10
49,500-52,200	19	56	30	10
52,500-55,200	22	63	30	10
55,500-58,200	22	63	30	10
59,500-62,200	22	63	30	10
62,500-65,200	27	71	30	12
69,500-72,200	27	71	30	12
72,200-75,200	27	71	30	12

* Intermediate diameters which are not listed in these tables can be produced as custom design on request.

Dimensions in mm.
 d_2 = nominal diameter d_1 of suitable holder!
 Cutting data see page 367 ff.

Shell reamer I 031211

Preferred series

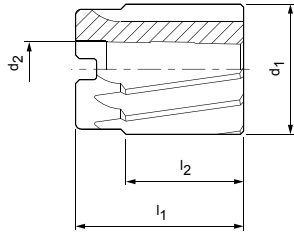

Design:

Diameter: 25,00-100,00 mm
 Cutting direction: Right-hand cutting
 Cutting material: HSS-E, uncoated
 Flute direction: Spiral fluted

Special feature:

Locating bore with 1:30 taper and driving slot acc. to DIN 138



Dimensions				z	Order No.
d ₁ H7	d ₂	l ₁	l ₂		
25,00	13	45	32	8	30107691
26,00	13	45	32	8	30107693
27,00	13	45	32	8	30107695
28,00	13	45	32	8	30107697
29,00	13	45	32	8	30107699
30,00	13	45	32	8	30107701
31,00	16	50	36	10	30107703
32,00	16	50	36	10	30107705
33,00	16	50	36	10	30107707
34,00	16	50	36	10	30107709
35,00	16	50	36	10	30107711
36,00	19	56	40	10	30107713
37,00	19	56	40	10	30107715
38,00	19	56	40	10	30107717
39,00	19	56	40	10	30331334
40,00	19	56	40	10	30107720
41,00	19	56	40	10	30331335
42,00	19	56	40	10	30107722
43,00	22	63	45	12	30243223
44,00	22	63	45	12	30107724
45,00	22	63	45	12	30107726
46,00	22	63	45	12	30107728
47,00	22	63	45	12	30107730
48,00	22	63	45	12	30107732
49,00	22	63	45	12	30331336
50,00	22	63	45	12	30107734
51,00	27	71	50	12	30331337
52,00	27	71	50	12	30107736
53,00	27	71	50	12	30209556
54,00	27	71	50	12	30306651
55,00	27	71	50	12	30107738
56,00	27	71	50	12	30209557
57,00	27	71	50	12	30331338
58,00	27	71	50	12	30107740
59,00	27	71	50	12	30562201
60,00	27	71	50	12	30107742
61,00	32	80	56	14	30331432
62,00	32	80	56	14	30107744
63,00	32	80	56	14	30331433

Shell reamer I 031211, locating bore with 1:30 taper and driving slot acc. to DIN 138

Dimensions				z	Order No.
d ₁ H7	d ₂	l ₁	l ₂		
64,00	32	80	56	14	30331434
65,00	32	80	56	14	30107746
66,00	32	80	56	14	30528877
67,00	32	80	56	14	30562204
68,00	32	80	56	14	30107748
69,00	32	80	56	14	30331441
70,00	32	80	56	14	30107750
72,00	40	90	63	14	30107752
73,00	40	90	63	14	30331443
74,00	40	90	63	14	30331444
75,00	40	90	63	14	30107754
76,00	40	90	63	14	30216490
78,00	40	90	63	14	30107756
80,00	40	90	63	14	30107758
82,00	40	90	63	14	30107760
83,00	40	90	63	14	30331446
84,00	40	90	63	14	30331447
85,00	40	90	63	14	30107762
86,00	50	100	71	16	30331449
87,00	50	100	71	16	30331450
88,00	50	100	71	16	30107764
90,00	50	100	71	16	30107766
92,00	50	100	71	16	30107768
94,00	50	100	71	16	30403707
95,00	50	100	71	16	30107770
96,00	50	100	71	16	30331451
98,00	50	100	71	16	30107772
100,00	50	100	71	16	30107774

Dimensions in mm.

d₂ = nominal diameter d₁ of suitable holder!

Cutting data see page 367 ff.

Intermediate diameters and special tolerances can be ordered by the overview pages for configurable series on the following page.

Shell reamer I 031211

Configurable series

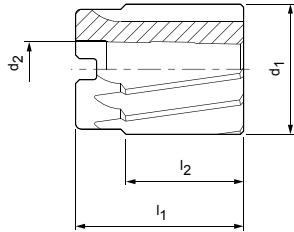

Design:

Diameter: 24,200-100,200 mm
 Cutting direction: Right-hand cutting
 Cutting material: HSS-E, uncoated
 Flute direction: Spiral fluted

Special feature:

Locating bore with 1:30 taper and driving slot acc. to DIN 138



Dimensions *					z
d ₁	d ₂	l ₁	l ₂		
24,200-25,200	13	45	32	8	
25,201-26,200	13	45	32	8	
26,201-28,200	13	45	32	8	
28,200-30,200	13	45	32	8	
30,201-32,200	16	50	36	10	
32,201-34,200	16	50	36	10	
34,201-35,200	16	50	36	10	
35,201-36,200	19	56	40	10	
36,201-38,200	19	56	40	10	
38,201-40,200	19	56	40	10	
40,201-42,200	19	56	40	10	
42,201-44,200	22	63	45	12	
44,201-45,200	22	63	45	12	
45,201-46,200	22	63	45	12	
46,201-48,200	22	63	45	12	
48,201-50,200	22	63	45	12	
50,201-52,200	27	71	50	12	
52,201-55,200	27	71	50	12	
55,201-58,200	27	71	50	12	
58,201-60,200	27	71	50	12	
60,201-62,200	32	80	56	14	
62,201-65,200	32	80	56	14	
65,201-68,200	32	80	56	14	
68,201-70,200	32	80	56	14	
71,201-72,200	40	90	63	14	
72,201-75,200	40	90	63	14	
75,201-78,200	40	90	63	14	
78,201-80,200	40	90	63	14	
80,201-82,200	40	90	63	14	
82,201-85,200	40	90	63	14	
86,000-90,200	50	100	71	16	
91,000-95,200	50	100	71	16	
96,000-100,200	50	100	71	16	

* Intermediate diameters which are not listed in these tables can be produced as custom design on request.

Dimensions in mm.

d_2 = nominal diameter d_1 of suitable holder!

Cutting data see page 367 ff.

Shell helical reamer I 031310

Preferred series

Design:

Diameter: 25,00-100,00 mm
 Cutting direction: Right-hand cutting
 Cutting material: HSS-E, uncoated
 Flute direction: Spiral fluted

Special feature:

Locating bore with
 1:30 taper and driving
 slot acc. to DIN 138

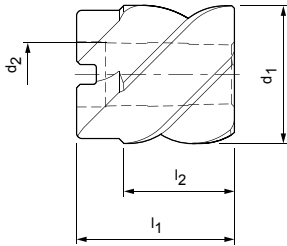

Dimensions				z	Order No.
d_1 H7	d_2	l_1	l_2		
25,00	13	45	32	3	30107776
26,00	13	45	32	3	30107778
27,00	13	45	32	3	30107780
28,00	13	45	32	3	30107782
29,00	13	45	32	3	30107784
30,00	13	45	32	3	30107786
31,00	16	50	36	3	30107788
32,00	16	50	36	3	30107790
34,00	16	50	36	3	30107794
35,00	16	50	36	3	30107796
36,00	19	56	40	5	30107798
37,00	19	56	40	5	30107800
38,00	19	56	40	5	30107802
40,00	19	56	40	5	30107804
42,00	19	56	40	5	30107806
44,00	22	63	45	5	30107808
45,00	22	63	45	5	30107810
46,00	22	63	45	5	30107812
47,00	22	63	45	5	30107814
48,00	22	63	45	5	30107816
50,00	22	63	45	5	30107818
52,00	27	71	50	5	30107820
55,00	27	71	50	5	30107822
58,00	27	71	50	5	30134726
60,00	27	71	50	5	30107825
62,00	32	80	56	5	30107827
65,00	32	80	56	5	30107829
68,00	32	80	56	5	30107831
70,00	32	80	56	5	30107833
72,00	40	90	63	5	30107835
75,00	40	90	63	5	30107837
78,00	40	90	63	5	30107839
80,00	40	90	63	5	30107841
82,00	40	90	63	7	30107843
85,00	40	90	63	7	30107845
90,00	50	100	71	7	30107849
95,00	50	100	71	7	30107853
100,00	50	100	71	7	30107857

Dimensions in mm. d_2 = nominal diameter d_1 of suitable holder!

Intermediate diameters and special tolerances can be ordered by the overview pages for configurable series on the following page.

Shell helical reamer I 031310

Configurable series

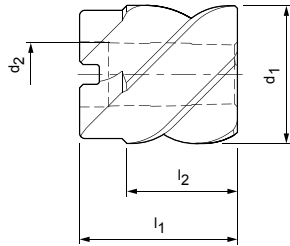

Design:

Diameter: 24,200-100,200 mm
 Cutting direction: Right-hand cutting
 Cutting material: HSS-E, uncoated
 Flute direction: Spiral fluted

Special feature:

Locating bore with 1:30 taper and driving slot acc. to DIN 138



Dimensions *					z
d ₁	d ₂	l ₁	l ₂		
24,200-25,200	13	45	32	3	
25,201-26,200	13	45	32	3	
27,000-28,200	13	45	32	3	
29,000-30,200	13	45	32	3	
31,000-32,200	16	50	36	3	
33,000-34,200	16	50	36	3	
34,201-35,200	16	50	36	3	
35,201-36,200	19	56	40	5	
37,000-38,200	19	56	40	5	
39,000-40,200	19	56	40	5	
41,000-42,200	19	56	40	5	
43,000-44,200	22	63	45	5	
44,201-45,200	22	63	45	5	
45,201-46,200	22	63	45	5	
47,000-48,200	22	63	45	5	
49,000-50,200	22	63	45	5	
51,000-52,200	27	71	50	5	
54,000-55,200	27	71	50	5	
57,000-58,200	27	71	50	5	
59,000-60,200	27	71	50	5	
61,000-62,200	32	80	56	5	
64,000-65,200	32	80	56	5	
67,000-68,200	32	80	56	5	
69,000-70,200	32	80	56	5	
71,000-72,200	40	90	63	5	
74,000-75,200	40	90	63	5	
77,000-78,200	40	90	63	5	
79,000-80,200	40	90	63	5	
81,000-82,200	40	90	63	7	
84,000-85,200	40	90	63	7	
89,000-90,200	50	100	71	7	
94,000-95,200	50	100	71	7	
99,000-100,200	50	100	71	7	

* Intermediate diameters which are not listed in these tables can be produced as custom design on request.

Dimensions in mm.

d_2 = nominal diameter d_1 of suitable holder!

Cutting data see page 367 ff.

Holder I 031610, 031611, 031612

1:30 taper, with driving ring and release nut, for shell reamers DIN 219, DIN 8054 and shell core drills DIN 222

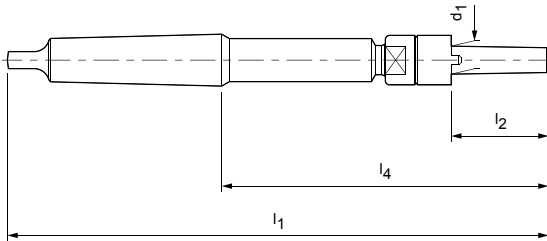

Dimensions								031610	031611	031612
d ₁	DIN 219	DIN 8054	DIN 222	l ₁	l ₂	l ₄	MK	Order No.	Order No.	Order No.
13,00	25-30	25-35	24-35	250	45	151	3	30107905		
16,00	31-35	36-45	36-45	261	50	162	3	30107907		
19,00	36-42	46-52	46-53	298	56	174	4	30107909		
19,00	36-42	46-52	46-53	273	56	174	3		30107921	
22,00	43-50	53-62	54-63	312	63	188	4	30107911		
22,00	43-50	53-62	54-63	287	63	188	3		30107923	
27,00	51-60	63-75	64-75	359	71	203	5	30107913		
27,00	51-60	63-75	64-75	327	71	203	4			30107925
32,00	61-71		76-90	376	80	220	5	30107915		
32,00	61-71		76-90	344	80	220	4			30107927
40,00	72-85		91-100	396	90	240	5	30107917		
50,00	86-100			416	100	260	5	30107919		

The following spare parts are also available from our stock:

Driving rings | 031511

Release nuts | 031512

Washers | 031513





REAMING WITHOUT INTERNAL COOLING

Introduction

Product overview 196

Machine reamer

Machine reamers with carbide cutting edges 199

Machine reamers made of HSS-E 231

PRODUCT OVERVIEW

Machine reamers without internal cooling

With small to medium lot sizes or when machining on older machines without internal coolant supply, the advantages of the high cutting data of the high-performance reamers cannot be utilised. The lower cost DIN reamers are a more cost-effective solution here. BECK machine reamers are available as carbide and HSS variants. High availability from stock and the consistently high quality of the raw materials used are of course

features of this product segment from BECK.

BECK machine reamers are available from stock in diameters up to 50 mm (depending on the type of tool). BECK miniature reamers are available from a diameter of 0.6 mm as a speciality. In addition, special machine expandable reamers, bridge reamers, helical machine reamers and face cutting reamers are available from stock.



NC machine reamers in accordance to DIN

Made of carbide and HSS-E, with straight shank diameter suitable for the connection in hydraulic chucks, high-accuracy chucks and shrink chucks. Only inductive shrink units are to be used for tools with brazed blades and steel shank.

Ø range: 0.6-30.00 mm



H7 +4 µm



Machine reamers in accordance to DIN

Made of carbide and HSS-E in designs with cylindrical shank and with Morse taper shank.

Ø range: 0.95-50.00 mm



H7 +4 µm



Special machine reamers in accordance to DIN and works standard

Carbide-tipped machine expandable reamers can be expanded by approximately 0.03 mm by means of the front screw, with cylindrical shank and Morse taper shank. Machine reamers WN 280 with precutting step and Morse taper shank.

Ø range: 8.00-40.00 mm

Basic
LINE

H7



Special machine reamers in accordance to DIN and works standard

Made of HSS-E with cylindrical shank and Morse taper shank. Helical machine reamer with approximately 45° left-hand spiral for long chipping workpiece materials. Bridge reamers for equalising separate bores that are not flush. Machine reamers with face cut.

Ø range: 2.50-40.00 mm

Basic
LINE

H7 +4 µm





REAMING WITHOUT INTERNAL COOLING

Machine reamers with carbide cutting edges

DIN 8093-2 A	040210 _____	200
Micro reamers sDIN 8093 B	040240 _____	202
DIN 8093-2 B	040211 _____	203
DIN 8093-2 B, TiAlN coated	043211 _____	207
NC reamers sDIN 8093 B	040245 _____	209
DIN 8093-1 A	040200 _____	211
DIN 8093-1 B	040201 _____	213
DIN 8090 B	040230 _____	215
DIN 8094 A, solid carbide head	040420 _____	217
DIN 8094 B, solid carbide head	040422 _____	219
DIN 8094 A, carbide blades	040421 _____	221
DIN 8094 B, carbide blades	040423 _____	223
Expandable reamers sDIN 8050	040311 _____	225
Expandable reamers sDIN 8051	040511 _____	227
WN 280 with precutting step	040512 _____	229

NC machine reamer I 040210*

Preferred series, with straight shank diameter suitable for direct clamping in hydraulic, high-precision and shrink chucks**

Design:

Diameter: 1,00-20,00 mm
 Cutting direction: Right-hand cutting
 Cutting material: Carbide, uncoated
 Flute direction: Straight fluted
 Geometry: EU spacing (from \varnothing 3 mm)

Special feature:

\varnothing 1-13 mm
 Solid carbide design

 \varnothing 14-20 mm
 Designed with brazed carbide blades and steel shank

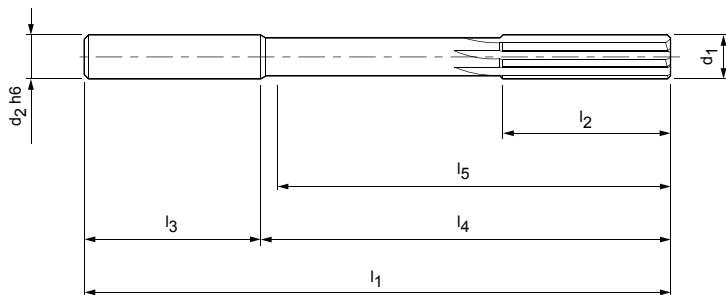

Dimensions							z	Order No.
d_1 H7	d_2 h6	l_1	l_2	l_3	l_4	l_5		
1,00	3	50	6	28	22	17,5	3	30670539
1,10	3	50	9	28	22	17,5	3	30670540
1,20	3	50	9	28	22	17,5	3	30670541
1,50	3	50	9	28	22	18	3	30670543
1,60	3	50	10	28	22	18	3	30670544
1,80	3	50	11	28	22	18,5	4	30670545
2,00	3	50	12	28	22	18,5	4	30670546
2,20	3	50	12	28	22	18,5	4	30670547
2,50	3	60	16	28	32	29	4	30670548
3,00	4	65	17	28	37	33	6	30670549
3,20	4	65	18	28	37	33	6	30670550
3,50	4	75	18	28	47	43	6	30670551
4,00	4	75	19	28	47	43	6	30612427
4,50	6	80	21	36	44	39	6	30612428
5,00	6	93	23	36	57	52	6	30612429
5,50	6	93	26	36	57	53	6	30612430
6,00	6	93	26	36	57	53	6	30612431
6,50	6	101	28	36	65	61	6	30612432
7,00	8	109	31	36	73	68	6	30612433
7,50	8	109	31	36	73	68	6	30612434
8,00	8	117	33	36	81	77	6	30612435
8,50	8	117	33	36	81	77	6	30612436
9,00	10	125	36	40	85	80	6	30612437
9,50	10	125	36	40	85	80	6	30612438
10,00	10	133	38	40	93	88	6	30612439
10,50	10	133	38	40	93	88	6	30612440
11,00	10	142	41	40	102	97	6	30612441
12,00	12	151	44	45	106	100	6	30612442
13,00	12	151	44	45	106	100	6	30612443
14,00	16	160	47	48	112	106	6	30612444
15,00	16	162	50	48	114	108	6	30612445
16,00	16	170	52	48	122	116	6	30612446
17,00	18	175	52	48	127	121	6	30612447
18,00	18	182	52	48	134	128	6	30612448
19,00	20	189	52	50	139	133	6	30612449
20,00	20	195	52	50	145	139	6	30612450

Dimensions in mm. Cutting data see page 367 ff.

Information on special designs and other coatings on request.

(**) Please only use inductive acting shrink devices for tools with brazed blades and steel shank!

(*) Due to the redefinition of DIN 8093 these product series replace our previous code 040244. Since the stock adjustment is done successively, during the transition phase we will sometimes still deliver tools with the previous designations and dimensions.

NC machine reamer I 040210*

Configurable series, with straight shank diameter suitable for direct clamping in hydraulic, high-precision and shrink chucks**

Design:

Diameter: 0,950-20,000 mm
 Cutting direction: Right-hand cutting
 Cutting material: Carbide, uncoated
 Flute direction: Straight fluted
 Geometry: EU spacing (from \varnothing 3 mm)

Special feature:

\varnothing 0,950-13,200 mm
 Solid carbide design

 \varnothing 13,201-20,000 mm
 Designed with brazed carbide blades and steel shank

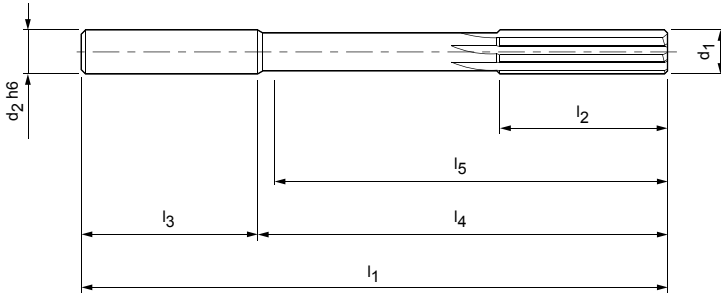

Dimensions							z
d_1	d_2 h6	l_1	l_2	l_3	l_4	l_5	
0,950-1,060	3	50	6	28	22	17,5	3
1,061-1,180	3	50	9	28	22	17,5	3
1,181-1,320	3	50	9	28	22	17,5	3
1,321-1,500	3	50	9	28	22	18	3
1,501-1,700	3	50	10	28	22	18	3
1,701-1,900	3	50	11	28	22	18,5	4
1,901-2,120	3	50	12	28	22	18,5	4
2,121-2,360	3	50	12	28	22	18,5	4
2,361-2,650	3	60	16	28	32	29	4
2,651-2,800	4	65	17	28	37	33	6
2,801-3,030	4	65	17	28	37	33	6
3,031-3,350	4	65	18	28	37	33	6
3,351-3,750	4	75	18	28	47	43	6
3,751-4,250	4	75	19	28	47	43	6
4,251-4,750	6	80	21	36	44	39	6
4,751-5,300	6	93	23	36	57	52	6
5,301-6,030	6	93	26	36	57	53	6
6,031-6,700	6	101	28	36	65	61	6
6,701-7,500	8	109	31	36	73	68	6
7,501-8,040	8	117	33	36	81	77	6
8,041-8,500	8	117	33	36	81	77	6
8,501-9,040	10	125	36	40	85	80	6
9,041-9,500	10	125	36	40	85	80	6
9,501-10,050	10	133	38	40	93	88	6
10,051-10,600	10	133	38	40	93	88	6
10,601-11,800	10	142	41	40	102	97	6
11,801-12,500	12	151	44	45	106	100	6
12,501-13,200	12	151	44	45	106	100	6
13,201-14,000	16	160	47	48	112	106	6
14,001-15,000	16	162	50	48	114	108	6
15,001-16,000	16	170	52	48	122	116	6
16,001-17,000	18	175	52	48	127	121	6
17,001-18,000	18	182	52	48	134	128	6
18,001-19,000	20	189	52	50	139	133	6
19,001-20,000	20	195	52	50	145	139	6

Dimensions in mm. Cutting data see page 367 ff.

Information on special designs and other coatings on request.

(**) Please only use inductive acting shrink devices for tools with brazed blades and steel shank!

(*) Due to the redefinition of DIN 8093 these product series replace our previous code 040244. Since the stock adjustment is done successively, during the transition phase we will sometimes still deliver tools with the previous designations and dimensions.

Micro NC machine reamer I 040240*

Preferred series, with straight shank diameter suitable for direct clamping in hydraulic, high-precision and shrink chucks

Design:

Diameter:

Cutting direction:

Cutting material:

Flute direction:

0,60-0,90 mm

Right-hand cutting

Solid carbide,
uncoated

Spiral fluted

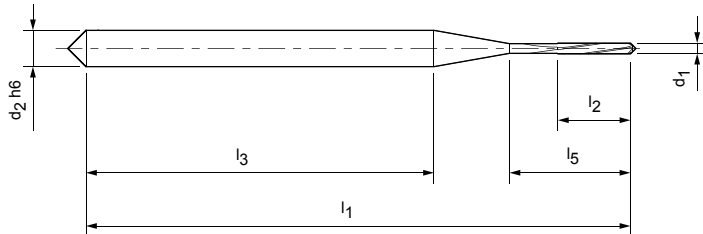

Dimensions						z	Order No.
$d_1 +0,004$	$d_2 h6$	l_1	l_2	l_3	l_5		
0,60	3	45	5	28	7,5	4	30274506
0,70	3	45	5	28	7,5	4	30274507
0,80	3	45	6	28	8	4	30274508
0,90	3	45	6	28	8	4	30274509

* Intermediate diameters and special tolerances on request. Minimum order quantity 10 pieces per dimension!

Dimensions in mm.

Cutting data see page 367 ff.

NC machine reamer I 040211*

Preferred series, with straight shank diameter suitable for direct clamping in hydraulic, high-precision and shrink chucks**

Design:

Diameter: 0,98-20,00 mm
 Cutting direction: Right-hand cutting
 Cutting material: Carbide, uncoated
 Flute direction: Spiral fluted
 Geometry: EU spacing (from \varnothing 3 mm)

Special feature:

\varnothing 0,98-13 mm
 Solid carbide design

 \varnothing 14-20 mm
 Left-hand fluted with
 brazed carbide blades
 and hardened steel
 shank

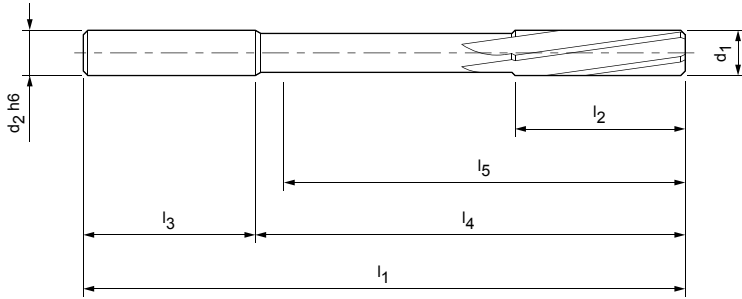

Dimensions								z	Order No.
d_1	Tolerance	$d_2 h_6$	l_1	l_2	l_3	l_4	l_5		
0,98	+0,004	3	50	6	28	22	17,5	3	30612451
0,99	+0,004	3	50	6	28	22	17,5	3	30612452
1,00	H7	3	50	6	28	22	17,5	3	30612453
1,01	+0,004	3	50	6	28	22	17,5	3	30612454
1,02	+0,004	3	50	6	28	22	17,5	3	30612455
1,03	+0,004	3	50	6	28	22	17,5	3	30612456
1,10	H7	3	50	9	28	22	17,5	3	30612457
1,20	H7	3	50	9	28	22	17,5	3	30612458
1,48	+0,004	3	50	9	28	22	18	3	30612459
1,49	+0,004	3	50	9	28	22	18	3	30612460
1,50	H7	3	50	9	28	22	18	3	30612461
1,51	+0,004	3	50	10	28	22	18	3	30612462
1,52	+0,004	3	50	10	28	22	18	3	30612463
1,53	+0,004	3	50	10	28	22	18	3	30612464
1,60	H7	3	50	10	28	22	18	3	30612465
1,80	H7	3	50	11	28	22	18,5	4	30612466
1,98	+0,004	3	50	12	28	22	18,5	4	30612467
1,99	+0,004	3	50	12	28	22	18,5	4	30612468
2,00	H7	3	50	12	28	22	18,5	4	30612469
2,01	+0,004	3	50	12	28	22	18,5	4	30612470
2,02	+0,004	3	50	12	28	22	18,5	4	30612471
2,03	+0,004	3	50	12	28	22	18,5	4	30612472
2,20	H7	3	50	12	28	22	18,5	4	30612473
2,48	+0,004	3	60	16	28	32	29	4	30612474
2,49	+0,004	3	60	16	28	32	29	4	30612475
2,50	H7	3	60	16	28	32	29	4	30612476
2,51	+0,004	3	60	16	28	32	29	4	30612477
2,52	+0,004	3	60	16	28	32	29	4	30612478
2,53	+0,004	3	60	16	28	32	29	4	30612479
2,97	+0,004	4	65	17	28	37	33	6	30612480
2,98	+0,004	4	65	17	28	37	33	6	30612481
2,99	+0,004	4	65	17	28	37	33	6	30612482
3,00	H7	4	65	17	28	37	33	6	30612483
3,01	+0,004	4	65	17	28	37	33	6	30612484
3,02	+0,004	4	65	17	28	37	33	6	30612485
3,03	+0,004	4	65	17	28	37	33	6	30612486
3,20	H7	4	65	18	28	37	33	6	30612487
3,50	H7	4	75	18	28	47	43	6	30612488

NC machine reamer I 040211*, preferred series in accordance to DIN 8093-2B

Dimensions								z	Order No.
d ₁	Tolerance	d ₂ h6	l ₁	l ₂	l ₃	l ₄	l ₅		
3,97	+0,004	4	75	19	28	47	43	6	30612489
3,98	+0,004	4	75	19	28	47	43	6	30612490
3,99	+0,004	4	75	19	28	47	43	6	30612491
4,00	H7	4	75	19	28	47	43	6	30612492
4,01	+0,004	4	75	19	28	47	43	6	30612493
4,02	+0,004	4	75	19	28	47	43	6	30612494
4,03	+0,004	4	75	19	28	47	43	6	30612495
4,50	H7	6	80	21	36	44	39	6	30612496
4,97	+0,004	6	93	23	36	57	52	6	30612497
4,98	+0,004	6	93	23	36	57	52	6	30612498
4,99	+0,004	6	93	23	36	57	52	6	30612499
5,00	H7	6	93	23	36	57	52	6	30612500
5,01	+0,004	6	93	23	36	57	52	6	30612501
5,02	+0,004	6	93	23	36	57	52	6	30612502
5,03	+0,004	6	93	23	36	57	52	6	30612503
5,50	H7	6	93	26	36	57	53	6	30612504
5,97	+0,004	6	93	26	36	57	53	6	30612505
5,98	+0,004	6	93	26	36	57	53	6	30612506
5,99	+0,004	6	93	26	36	57	53	6	30612507
6,00	H7	6	93	26	36	57	53	6	30612508
6,01	+0,004	6	93	26	36	57	53	6	30612509
6,02	+0,004	6	93	26	36	57	53	6	30612510
6,03	+0,004	6	93	26	36	57	53	6	30612511
6,50	H7	6	101	28	36	65	61	6	30612512
7,00	H7	8	109	31	36	73	68	6	30612513
7,50	H7	8	109	31	36	73	68	6	30612514
7,97	+0,004	8	117	33	36	81	77	6	30612515
7,98	+0,004	8	117	33	36	81	77	6	30612516
7,99	+0,004	8	117	33	36	81	77	6	30612517
8,00	H7	8	117	33	36	81	77	6	30612518
8,01	+0,004	8	117	33	36	81	77	6	30612519
8,02	+0,004	8	117	33	36	81	77	6	30612520
8,03	+0,004	8	117	33	36	81	77	6	30612521
8,04	+0,004	8	117	33	36	81	77	6	30612522
8,50	H7	8	117	33	36	81	77	6	30612523
9,00	H7	10	125	36	40	85	80	6	30612524
9,50	H7	10	125	36	40	85	80	6	30612525
9,97	+0,004	10	133	38	40	93	88	6	30612526
9,98	+0,004	10	133	38	40	93	88	6	30612527
9,99	+0,004	10	133	38	40	93	88	6	30612528
10,00	H7	10	133	38	40	93	88	6	30612529
10,01	+0,004	10	133	38	40	93	88	6	30612530
10,02	+0,004	10	133	38	40	93	88	6	30612531
10,03	+0,004	10	133	38	40	93	88	6	30612532
10,04	+0,004	10	133	38	40	93	88	6	30612533
10,05	+0,004	10	133	38	40	93	88	6	30612534
10,50	H7	10	133	38	40	93	88	6	30612535
11,00	H7	10	142	41	40	102	97	6	30612536
11,97	+0,004	12	151	44	45	106	100	6	30612537
11,98	+0,004	12	151	44	45	106	100	6	30612538
11,99	+0,004	12	151	44	45	106	100	6	30612539
12,00	H7	12	151	44	45	106	100	6	30612540
12,01	+0,004	12	151	44	45	106	100	6	30612541
12,02	+0,004	12	151	44	45	106	100	6	30612542
12,03	+0,004	12	151	44	45	106	100	6	30612543
12,04	+0,004	12	151	44	45	106	100	6	30612544
12,05	+0,004	12	151	44	45	106	100	6	30612545

NC machine reamer I 040211*, preferred series in accordance to DIN 8093-2B

Dimensions								z	Order No.
d ₁	Tolerance	d ₂ h6	l ₁	l ₂	l ₃	l ₄	l ₅		
13,00	H7	12	151	44	45	106	100	6	30612546
14,00	H7	16	160	47	48	112	106	6	30612547
15,00	H7	16	162	50	48	114	108	6	30612548
16,00	H7	16	170	52	48	122	116	6	30612549
17,00	H7	18	175	52	48	127	121	6	30612550
18,00	H7	18	182	52	48	134	128	6	30612551
19,00	H7	20	189	52	50	139	133	6	30612552
20,00	H7	20	195	52	50	145	139	6	30612553

Dimensions in mm. Cutting data see page 367 ff.

Information on special designs and other coatings on request.

(**) Please only use inductive acting shrink devices for tools with brazed blades and steel shank!

(*) Due to the redefinition of DIN 8093 these product series replace our previous code 040245 (up to ø 20 mm). Since the stock adjustment ist done successively, during the transition phase we will sometimes still deliver tools with the previous designations and dimensions.

NC machine reamer I 040211*

Configurable series, with straight shank diameter suitable for direct clamping in hydraulic, high-precision and shrink chucks**

Design:

Diameter: 0,951-20,000 mm
 Cutting direction: Right-hand cutting
 Cutting material: Carbide, uncoated
 Flute direction: Spiral fluted
 Geometry: EU spacing (from \varnothing 3 mm)

Special feature:

\varnothing 0,951-13,200 mm
 Solid carbide design

\varnothing 13,201-20,000 mm
 Left-hand fluted with
 brazed carbide blades
 and hardened steel
 shank

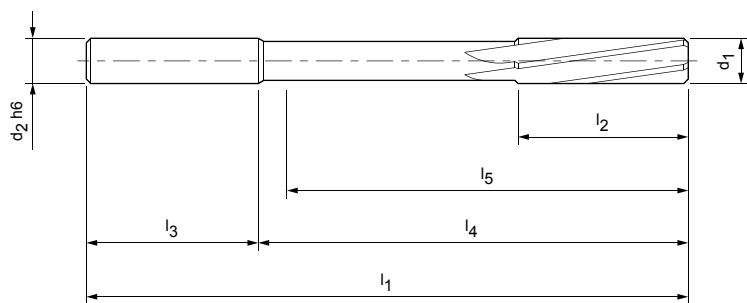

Dimensions							z
d_1	d_2 h6	l_1	l_2	l_3	l_4	l_5	
0,951-1,060	3	50	6	28	22	17,5	3
1,061-1,180	3	50	9	28	22	17,5	3
1,181-1,320	3	50	9	28	22	17,5	3
1,321-1,500	3	50	9	28	22	18	3
1,501-1,700	3	50	10	28	22	18	3
1,701-1,900	3	50	11	28	22	18,5	4
1,901-2,120	3	50	12	28	22	18,5	4
2,121-2,360	3	50	12	28	22	18,5	4
2,361-2,650	3	60	16	28	32	29	4
2,651-2,800	4	65	17	28	37	33	6
2,801-3,030	4	65	17	28	37	33	6
3,031-3,350	4	65	18	28	37	33	6
3,351-3,750	4	75	18	28	47	43	6
3,751-4,250	4	75	19	28	47	43	6
4,251-4,750	6	80	21	36	44	39	6
4,751-5,300	6	93	23	36	57	52	6
5,301-6,030	6	93	26	36	57	53	6
6,031-6,700	6	101	28	36	65	61	6
6,701-7,500	8	109	31	36	73	68	6
7,501-8,040	8	117	33	36	81	77	6
8,041-8,500	8	117	33	36	81	77	6
8,501-9,040	10	125	36	40	85	80	6
9,041-9,500	10	125	36	40	85	80	6
9,501-10,050	10	133	38	40	93	88	6
10,051-10,600	10	133	38	40	93	88	6
10,601-11,800	10	142	41	40	102	97	6
11,801-12,500	12	151	44	45	106	100	6
12,501-13,200	12	151	44	45	106	100	6
13,201-14,000	16	160	47	48	112	106	6
14,001-15,000	16	162	50	48	114	108	6
15,001-16,000	16	170	52	48	122	116	6
16,001-17,000	18	175	52	48	127	121	6
17,001-18,000	18	182	52	48	134	128	6
18,001-19,000	20	189	52	50	139	133	6
19,001-20,000	20	195	52	50	145	139	6

Dimensions in mm. Cutting data see page 367 ff.

Information on special designs and other coatings on request.

(**) Please only use inductive acting shrink devices for tools with brazed blades and steel shank!

(*) Due to the redefinition of DIN 8093 these product series replace our previous code 040245 (up to \varnothing 20 mm). Since the stock adjustment is done successively, during the transition phase we will sometimes still deliver tools with the previous designations and dimensions.

NC machine reamer I 043211*

Preferred series, with straight shank diameter suitable for direct clamping in hydraulic, high-precision and shrink chucks**

Design:

Diameter: 1,00-20,00 mm
 Cutting direction: Right-hand cutting
 Cutting material: Carbide, TiAlN coated
 Flute direction: Spiral fluted
 Geometry: EU spacing (from \varnothing 3 mm)

Special feature:

\varnothing 1-13 mm
 Solid carbide design

 \varnothing 14-20 mm
 Left-hand fluted with brazed carbide blades and hardened steel shank

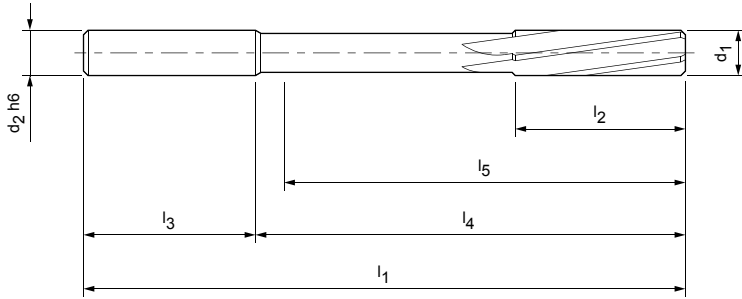

Dimensions							z	Order No.
d_1 H7	d_2 h6	l_1	l_2	l_3	l_4	l_5		
1,00	3	50	6	28	22	17,5	3	30612554
1,20	3	50	9	28	22	17,5	3	30612555
1,50	3	50	9	28	22	18	3	30612556
1,60	3	50	10	28	22	18	3	30612557
1,80	3	50	11	28	22	18,5	4	30612558
2,00	3	50	12	28	22	18,5	4	30612559
2,20	3	50	12	28	22	18,5	4	30612560
2,50	3	60	16	28	32	29	4	30612561
3,00	4	65	17	28	37	33	6	30612562
3,20	4	65	18	28	37	33	6	30612563
3,50	4	75	18	28	47	43	6	30612564
4,00	4	75	19	28	47	43	6	30612565
4,50	6	80	21	36	44	39	6	30612566
5,00	6	93	23	36	57	52	6	30612567
5,50	6	93	26	36	57	53	6	30612568
6,00	6	93	26	36	57	53	6	30612569
6,50	6	101	28	36	65	61	6	30612570
7,00	8	109	31	36	73	68	6	30612571
7,50	8	109	31	36	73	68	6	30612572
8,00	8	117	33	36	81	77	6	30612573
8,50	8	117	33	36	81	77	6	30612574
9,00	10	125	36	40	85	80	6	30612575
9,50	10	125	36	40	85	80	6	30612576
10,00	10	133	38	40	93	88	6	30612577
10,50	10	133	38	40	93	88	6	30612578
11,00	10	142	41	40	102	97	6	30612579
12,00	12	151	44	45	106	100	6	30612580
13,00	12	151	44	45	106	100	6	30612581
14,00	16	160	47	48	112	106	6	30612582
15,00	16	162	50	48	114	108	6	30612583
16,00	16	170	52	48	122	116	6	30612584
17,00	18	175	52	48	127	121	6	30612585
18,00	18	182	52	48	134	128	6	30612586
19,00	20	189	52	50	139	133	6	30612587
20,00	20	195	52	50	145	139	6	30612588

Dimensions in mm. Cutting data see page 367 ff.

Information on special designs and other coatings on request.

(**) Please only use inductive acting shrink devices for tools with brazed blades and steel shank!

(*) Due to the redefinition of DIN 8093 these product series replace our previous code 043245. Since the stock adjustment is done successively, during the transition phase we will sometimes still deliver tools with the previous designations and dimensions.

NC machine reamer I 043211*

Configurable series, with straight shank diameter suitable for direct clamping in hydraulic, high-precision and shrink chucks**

Design:

Diameter: 0,951-20,000 mm
 Cutting direction: Right-hand cutting
 Cutting material: Carbide, TiAlN coated
 Flute direction: Spiral fluted
 Geometry: EU spacing (from \varnothing 3 mm)

Special feature:

\varnothing 0,951-13,200 mm
 Solid carbide design

 \varnothing 13,201-20,000 mm
 Left-hand fluted with brazed carbide blades and hardened steel shank

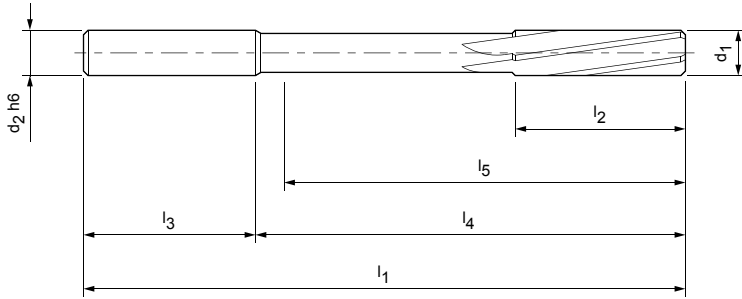

Dimensions							Z
d_1	d_2 h6	l_1	l_2	l_3	l_4	l_5	
0,951-1,060	3	50	6	28	22	17,5	3
1,061-1,180	3	50	9	28	22	17,5	3
1,181-1,320	3	50	9	28	22	17,5	3
1,321-1,500	3	50	9	28	22	18	3
1,501-1,700	3	50	10	28	22	18	3
1,701-1,900	3	50	11	28	22	18,5	4
1,901-2,120	3	50	12	28	22	18,5	4
2,121-2,360	3	50	12	28	22	18,5	4
2,361-2,650	3	60	16	28	32	29	4
2,651-2,800	4	65	17	28	37	33	6
2,801-3,030	4	65	17	28	37	33	6
3,031-3,350	4	65	18	28	37	33	6
3,351-3,750	4	75	18	28	47	43	6
3,751-4,250	4	75	19	28	47	43	6
4,251-4,750	6	80	21	36	44	39	6
4,751-5,300	6	93	23	36	57	52	6
5,301-6,030	6	93	26	36	57	53	6
6,031-6,700	6	101	28	36	65	61	6
6,701-7,500	8	109	31	36	73	68	6
7,501-8,040	8	117	33	36	81	77	6
8,041-8,500	8	117	33	36	81	77	6
8,501-9,040	10	125	36	40	85	80	6
9,041-9,500	10	125	36	40	85	80	6
9,501-10,050	10	133	38	40	93	88	6
10,051-10,600	10	133	38	40	93	88	6
10,601-11,800	10	142	41	40	102	97	6
11,801-12,500	12	151	44	45	106	100	6
12,501-13,200	12	151	44	45	106	100	6
13,201-14,000	16	160	47	48	112	106	6
14,001-15,000	16	162	50	48	114	108	6
15,001-16,000	16	170	52	48	122	116	6
16,001-17,000	18	175	52	48	127	121	6
17,001-18,000	18	182	52	48	134	128	6
18,001-19,000	20	189	52	50	139	133	6
19,001-20,000	20	195	52	50	145	139	6

Dimensions in mm. Cutting data see page 367 ff.

Information on special designs and other coatings on request.

(**) Please only use inductive acting shrink devices for tools with brazed blades and steel shank!

(*) Due to the redefinition of DIN 8093 these product series replace our previous code 043245. Since the stock adjustment is done successively, during the transition phase we will sometimes still deliver tools with the previous designations and dimensions.

NC machine reamer I 040245

Preferred series, with straight shank diameter suitable for direct clamping in hydraulic, high-precision and shrink chucks**

Design:

Diameter:
Cutting direction:
Cutting material:
Flute direction:
Geometry:

21,00-30,00 mm
Right-hand cutting
Carbide, uncoated
Left-hand fluted
EU spacing

Special feature:

Designed with brazed carbide blades and steel shank

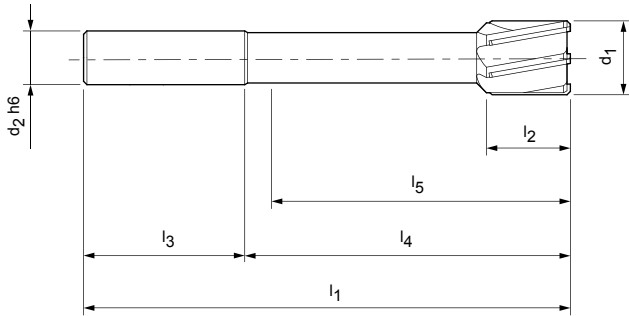

Dimensions							z	Order No.
$d_1 H7$	$d_2 h6$	l_1	l_2	l_3	l_4	l_5		
21,00	20	160	25	50	110	105	6	30215791
22,00	20	160	25	50	110	105	6	30215792
23,00	20	180	25	50	130	125	6	30242804
24,00	20	180	25	50	130	125	8	30109462
25,00	20	180	25	50	130	125	8	30109464
26,00	20	180	25	50	130	125	8	30109466
27,00	20	180	25	50	130	125	8	30242816
28,00	25	180	25	56	124	119	8	30109468
29,00	25	180	25	56	124	119	8	30242817
30,00	25	200	25	56	144	139	8	30109470

Dimensions in mm. Cutting data see page 367 ff.

Information on special designs and other coatings on request.

(**) Please only use inductive acting shrink devices for tools with brazed blades and steel shank!

NC machine reamer I 040245

Configurable series, with straight shank diameter suitable for direct clamping in hydraulic, high-precision and shrink chucks**

Design:

Diameter:
Cutting direction:
Cutting material:
Flute direction:
Geometry:

20,001-30,200 mm
Right-hand cutting
Carbide, uncoated
Left-hand fluted
EU spacing

Special feature:

with brazed carbide blades and steel shank

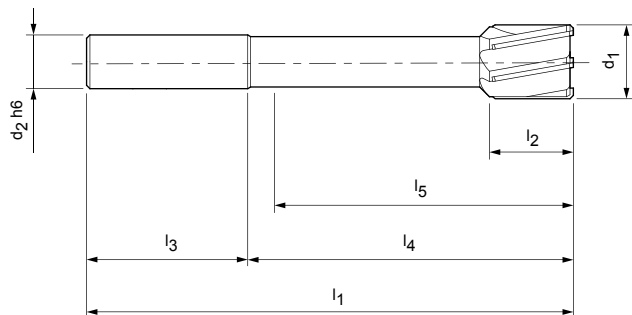

Dimensions							z
d ₁	d ₂ h6	l ₁	l ₂	l ₃	l ₄	l ₅	
20,001-21,200	20	160	25	50	110	105	6
21,201-22,200	20	160	25	50	110	105	6
22,201-23,200	20	180	25	50	130	125	6
23,201-24,200	20	180	25	50	130	125	8
24,201-25,200	20	180	25	50	130	125	8
25,201-26,200	20	180	25	50	130	125	8
26,201-27,200	20	180	25	50	130	125	8
27,201-28,200	25	180	25	56	124	119	8
28,201-29,200	25	180	25	56	124	119	8
29,201-30,200	25	200	25	56	144	139	8

Dimensions in mm. Cutting data see page 367 ff.

Information on special designs and other coatings on request.

(**) Please only use inductive acting shrink devices for tools with brazed blades and steel shank!

Machine reamer I 040200*

Preferred series, with long cutting section

Design:

Diameter: 1,00-20,00 mm
 Cutting direction: Right-hand cutting
 Cutting material: Carbide, uncoated
 Flute direction: Straight fluted
 Geometry: EU spacing (from \varnothing 3 mm)

Special feature:

\varnothing 1-13 mm
 Solid carbide design

 \varnothing 14-20 mm
 Design with brazed blades and steel shank

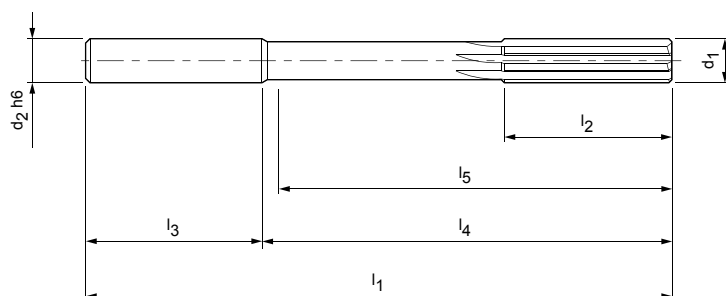

Dimensions							z	Order No.
d_1 H7	d_2 h6	l_1	l_2	l_3	l_4	l_5		
1,00	1	34	5,5	19	15	13	3	30612359
1,20	1,2	38	7,5	21,5	16,5	14,5	3	30612360
1,50	1,5	40	8	22	18	16	3	30612361
1,60	1,6	43	9	23	20	18	3	30612362
1,80	1,8	46	10	24	22	20	4	30612363
2,00	2	49	11	25	24	22	4	30612364
2,20	2,2	53	12	28	25	22	4	30612365
2,50	2,5	57	14	28	29	26	4	30612366
3,00	3	61	15	28	33	30	6	30612367
3,20	3,2	65	16	28	37	34	6	30612368
3,50	3,5	70	18	28	42	39	6	30612369
4,00	4	75	19	28	47	43	6	30612370
4,50	4,5	80	21	28	52	48	6	30612371
5,00	5	86	23	28	58	54	6	30612372
5,50	5,6	93	26	36	57	53	6	30612373
6,00	5,6	93	26	36	57	53	6	30612374
6,50	6,3	101	28	36	65	61	6	30612375
7,00	7,1	109	31	36	73	68	6	30612376
7,50	7,1	109	31	36	73	68	6	30612377
8,00	8	117	33	36	81	77	6	30612378
8,50	8	117	33	36	81	77	6	30612379
9,00	9	125	36	40	85	80	6	30612618
9,50	9	125	36	40	85	80	6	30612380
10,00	10	133	38	40	93	88	6	30612381
10,50	10	133	38	40	93	88	6	30612382
11,00	10	142	41	40	102	97	6	30612383
12,00	10	151	44	40	111	106	6	30612384
13,00	10	151	44	40	111	106	6	30612385
14,00	12,5	160	47	45	115	110	6	30612386
15,00	12,5	162	50	45	117	112	6	30612387
16,00	12,5	170	52	45	125	120	6	30612388
17,00	14	175	54	45	130	125	6	30612389
18,00	14	182	56	45	137	132	6	30612390
19,00	16	189	58	48	141	136	6	30612391
20,00	16	195	60	48	147	142	6	30612392

Dimensions in mm.

Cutting data see page 367 ff.

Information on special designs and other coatings on request.

(* Due to the redefinition of DIN 8093 these product series replace our previous codes 040112, 040110, 040219, 040222. Since the stock adjustment is done successively, during the transition phase we will sometimes still deliver tools with the previous designations and dimensions.

Machine reamer I 040200*

Configurable series, with long cutting section

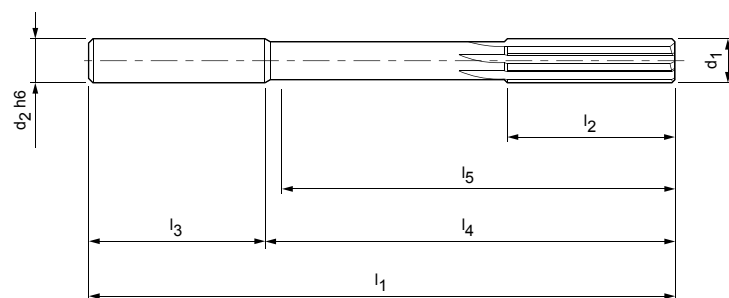

Design:

Diameter: 0,950-20,000 mm
 Cutting direction: Right-hand cutting
 Cutting material: Carbide, uncoated
 Flute direction: Straight fluted
 Geometry: EU spacing (from $\varnothing 3$ mm)

Special feature:

$\varnothing 0,950$ -13,200 mm
 Solid carbide design

$\varnothing 13,201$ -20,000 mm
 Design with brazed blades and steel shank



Dimensions							z
d_1	$d_2 h_6$	l_1	l_2	l_3	l_4	l_5	
0,950-1,060	1	34	5,5	19	15	13	3
1,061-1,180	1,1	36	6,5	20,5	15,5	13,5	3
1,181-1,320	1,2	38	7,5	21,5	16,5	14,5	3
1,321-1,500	1,5	40	8	22	18	16	3
1,501-1,700	1,6	43	9	23	20	18	3
1,701-1,900	1,8	46	10	24	22	20	4
1,901-2,120	2	49	11	25	24	22	4
2,121-2,360	2,2	53	12	28	25	22	4
2,361-2,650	2,5	57	14	28	29	26	4
2,651-2,800	3	61	15	28	33	30	6
2,801-3,030	3	61	15	28	33	30	6
3,031-3,350	3,2	65	16	28	37	34	6
3,351-3,750	3,5	70	18	28	42	39	6
3,751-4,250	4	75	19	28	47	43	6
4,251-4,750	4,5	80	21	28	52	48	6
4,751-5,300	5	86	23	28	58	54	6
5,301-6,030	5,6	93	26	36	57	53	6
6,031-6,700	6,3	101	28	36	65	61	6
6,701-7,500	7,1	109	31	36	73	68	6
7,501-8,040	8	117	33	36	81	77	6
8,041-8,500	8	117	33	36	81	77	6
8,501-9,040	9	125	36	40	85	80	6
9,041-9,500	9	125	36	40	85	80	6
9,501-10,050	10	133	38	40	93	88	6
10,051-10,600	10	133	38	40	93	88	6
10,601-11,800	10	142	41	40	102	97	6
11,801-12,500	10	151	44	40	111	106	6
12,501-13,200	10	151	44	40	111	106	6
13,201-14,000	12,5	160	47	45	115	110	6
14,001-15,000	12,5	162	50	45	117	112	6
15,001-16,000	12,5	170	52	45	125	120	6
16,001-17,000	14	175	54	45	130	125	6
17,001-18,000	14	182	56	45	137	132	6
18,001-19,000	16	189	58	48	141	136	6
19,001-20,000	16	195	60	48	147	142	6

Dimensions in mm.

Cutting data see page 367 ff.

Information on special designs and other coatings on request.

(* Due to the redefinition of DIN 8093 these product series replace our previous codes 040112, 040110, 040219, 040222. Since the stock adjustment is done successively, during the transition phase we will sometimes still deliver tools with the previous designations and dimensions.

Machine reamer I 040201*

Preferred series, with long cutting section

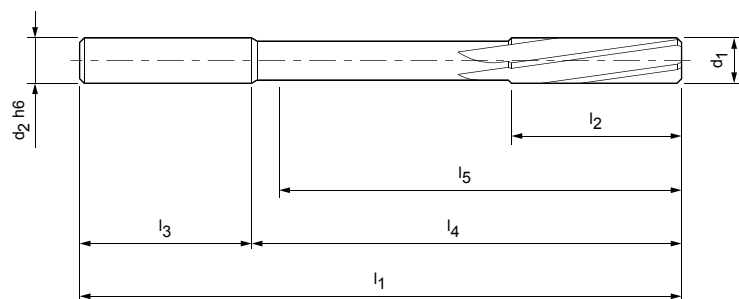

Design:

Diameter: 1,00-20,00 mm
 Cutting direction: Right-hand cutting
 Cutting material: Carbide, uncoated
 Flute direction: Spiral fluted ($\varnothing \leq 13$ mm)
 Left-hand fluted ($\varnothing \geq 14$ mm)
 Geometry: EU spacing (from $\varnothing 3$ mm)

Special feature:

$\varnothing 1-13$ mm
 Solid carbide design

 $\varnothing 14-20$ mm
 Design with brazed blades and steel shank

Dimensions							z	Order No.
d ₁ H7	d ₂ h6	l ₁	l ₂	l ₃	l ₄	l ₅		
1,00	1	34	5,5	19	15	13	3	30612393
1,20	1,2	38	7,5	21,5	16,5	14,5	3	30612394
1,50	1,5	40	8	22	18	16	3	30612395
1,60	1,6	43	9	23	20	18	3	30612396
1,80	1,8	46	10	24	22	20	4	30612397
2,00	2	49	11	25	24	22	4	30612398
2,20	2,2	53	12	28	25	22	4	30612399
2,50	2,5	57	14	28	29	26	4	30612400
3,00	3	61	15	28	33	30	6	30612401
3,20	3,2	65	16	28	37	34	6	30612402
3,50	3,5	70	18	28	42	39	6	30612403
4,00	4	75	19	28	47	43	6	30612404
4,50	4,5	80	21	28	52	48	6	30612405
5,00	5	86	23	28	58	54	6	30612406
5,50	5,6	93	26	36	57	53	6	30612407
6,00	5,6	93	26	36	57	53	6	30612408
6,50	6,3	101	28	36	65	61	6	30612409
7,00	7,1	109	31	36	73	68	6	30612410
7,50	7,1	109	31	36	73	68	6	30612411
8,00	8	117	33	36	81	77	6	30612412
8,50	8	117	33	36	81	77	6	30612413
9,00	9	125	36	40	85	80	6	30612619
9,50	9	125	36	40	85	80	6	30612414
10,00	10	133	38	40	93	88	6	30612415
10,50	10	133	38	40	93	88	6	30612416
11,00	10	142	41	40	102	97	6	30612417
12,00	10	151	44	40	111	106	6	30612418
13,00	10	151	44	40	111	106	6	30612419
14,00	12,5	160	47	45	115	110	6	30612420
15,00	12,5	162	50	45	117	112	6	30612421
16,00	12,5	170	52	45	125	120	6	30612422
17,00	14	175	54	45	130	125	6	30612423
18,00	14	182	56	45	137	132	6	30612424
19,00	16	189	58	48	141	136	6	30612425
20,00	16	195	60	48	147	142	6	30612426

Dimensions in mm.

Cutting data see page 367 ff.

Information on special designs and other coatings on request.

(*) Due to the redefinition of DIN 8093 these product series replace our previous codes 040113, 040111, 040220, 040223. Since the stock adjustment is done successively, during the transition phase we will sometimes still deliver tools with the previous designations and dimensions.

Machine reamer I 040201*

Configurable series, with long cutting section

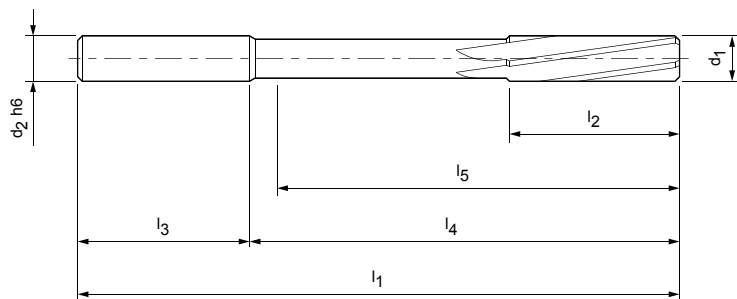

Design:

Diameter: 0,950-20,000 mm
 Cutting direction: Right-hand cutting
 Cutting material: Carbide, uncoated
 Flute direction: Spiral fluted ($\varnothing \leq 13$ mm)
 Left-hand fluted ($\varnothing \geq 14$ mm)
 Geometry: EU spacing
 (from $\varnothing 3$ mm)

Special feature:

$\varnothing 0,950-13,200$ mm
 Solid carbide design

 $\varnothing 13,201-20,000$ mm
 Design with brazed
 blades and steel shank

Dimensions							z
d_1	$d_2 h_6$	l_1	l_2	l_3	l_4	l_5	
0,950-1,060	1	34	5,5	19	15	13	3
1,061-1,180	1,1	36	6,5	20,5	15,5	13,5	3
1,181-1,320	1,2	38	7,5	21,5	16,5	14,5	3
1,321-1,500	1,5	40	8	22	18	16	3
1,501-1,700	1,6	43	9	23	20	18	3
1,701-1,900	1,8	46	10	24	22	20	4
1,901-2,120	2	49	11	25	24	22	4
2,121-2,360	2,2	53	12	28	25	22	4
2,361-2,650	2,5	57	14	28	29	26	4
2,651-2,800	3	61	15	28	33	30	6
2,801-3,030	3	61	15	28	33	30	6
3,031-3,350	3,2	65	16	28	37	34	6
3,351-3,750	3,5	70	18	28	42	39	6
3,751-4,250	4	75	19	28	47	43	6
4,251-4,750	4,5	80	21	28	52	48	6
4,751-5,300	5	86	23	28	58	54	6
5,301-6,030	5,6	93	26	36	57	53	6
6,031-6,700	6,3	101	28	36	65	61	6
6,701-7,500	7,1	109	31	36	73	68	6
7,501-8,040	8	117	33	36	81	77	6
8,041-8,500	8	117	33	36	81	77	6
8,501-9,040	9	125	36	40	85	80	6
9,041-9,500	9	125	36	40	85	80	6
9,501-10,050	10	133	38	40	93	88	6
10,051-10,600	10	133	38	40	93	88	6
10,601-11,800	10	142	41	40	102	97	6
11,801-12,500	10	151	44	40	111	106	6
12,501-13,200	10	151	44	40	111	106	6
13,201-14,000	12,5	160	47	45	115	110	6
14,001-15,000	12,5	162	50	45	117	112	6
15,001-16,000	12,5	170	52	45	125	120	6
16,001-17,000	14	175	54	45	130	125	6
17,001-18,000	14	182	56	45	137	132	6
18,001-19,000	16	189	58	48	141	136	6
19,001-20,000	16	195	60	48	147	142	6

Dimensions in mm.

Cutting data see page 367 ff.

Information on special designs and other coatings on request.

(* Due to the redefinition of DIN 8093 these product series replace our previous codes 040113, 040111, 040220, 040223. Since the stock adjustment is done successively, during the transition phase we will sometimes still deliver tools with the previous designations and dimensions.

Automatic lathe reamer I 040230

Preferred series, short design

Design:

Diameter:	3,00-12,00 mm
Cutting direction:	Right-hand cutting
Cutting material:	Solid carbide, uncoated
Flute direction:	Spiral fluted

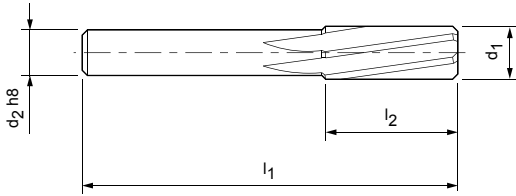

Dimensions				z	Order No.
d ₁ H7	d ₂ h8	l ₁	l ₂		
3,00	2,5	56	20	6	30109291
3,20	2,8	56	20	6	30109292
3,50	3	56	20	6	30109293
4,00	3,55	56	20	6	30109294
4,50	4	63	22	6	30109295
5,00	4	63	22	6	30109296
5,50	5	63	22	6	30109297
6,00	5	63	22	6	30109298
6,50	5	63	22	6	30109299
7,00	6,3	71	25	6	30109300
7,50	6,3	71	25	6	30109301
8,00	6,3	71	25	6	30109302
8,50	6,3	71	25	6	30109303
9,00	8	71	25	6	30109304
9,50	8	71	25	6	30109305
10,00	8	71	25	6	30109306
10,50	8	71	25	6	30109307
11,00	10	80	28	6	30109308
11,50	10	80	28	6	30109309
12,00	10	80	28	6	30109310

Dimensions in mm.

Cutting data see page 367 ff.

Information on special designs and other coatings on request.

Automatic lathe reamer I 040230

Configurable series, short design

Design:

Diameter: 2,890-12,200 mm
 Cutting direction: Right-hand cutting
 Cutting material: Solid carbide, uncoated
 Flute direction: Spiral fluted

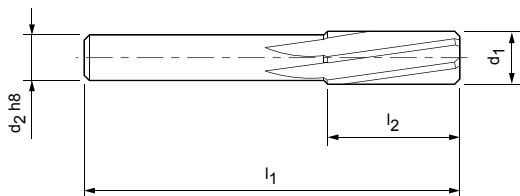

Dimensions				z
d ₁	d ₂ h8	l ₁	l ₂	
2,890-3,100	2,5	56	20	6
3,101-3,300	2,8	56	20	6
3,301-3,700	3	56	20	6
3,701-4,250	3,55	56	20	6
4,251-4,600	4	63	22	6
4,601-4,950	4	63	22	6
4,951-5,300	4	63	22	6
5,301-5,700	5	63	22	6
5,701-6,200	5	63	22	6
6,201-6,700	5	63	22	6
6,701-7,200	6,3	71	25	6
7,201-7,700	6,3	71	25	6
7,701-8,200	6,3	71	25	6
8,201-8,700	6,3	71	25	6
8,701-9,200	8	71	25	6
9,201-9,700	8	71	25	6
9,701-10,200	8	71	25	6
10,201-10,600	8	71	25	6
10,601-11,200	10	80	28	6
11,201-11,700	10	80	28	6
11,701-12,200	10	80	28	6

Dimensions in mm.

Cutting data see page 367 ff.

Information on special designs and other coatings on request.

Machine reamer I 040420

Preferred series with Morse taper shank, long cutting section and solid carbide head

Design:

Diameter:

Cutting direction:

Cutting material:

Flute direction:

Geometry:

5,00-16,00 mm

Right-hand cutting

Solid carbide, uncoated

Straight fluted

EU spacing

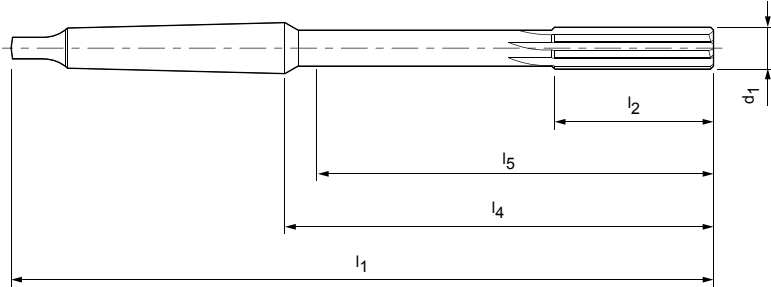

Dimensions						z	Order No.
d_1 H7	MK	l_1	l_2	l_4	l_5		
5,00	1	133	23	67,5	57	6	30109892
5,50	1	138	26	72,5	62	6	30312290
6,00	1	138	26	72,5	62	6	30109894
6,50	1	144	28	78,5	69	6	30312291
7,00	1	150	31	84,5	75	6	30109896
7,50	1	150	31	84,5	76	6	30312292
8,00	1	156	33	90,5	82	6	30109898
8,50	1	156	33	90,5	82	6	30312293
9,00	1	162	36	96,5	89	6	30109900
9,50	1	162	36	96,5	89	6	30312294
10,00	1	168	38	102,5	95	6	30109902
10,50	1	168	38	102,5	96	6	30312295
11,00	1	175	41	109,5	104	6	30109904
12,00	1	182	44	116,5	111	6	30109906
13,00	1	182	44	116,5	111	6	30109908
14,00	1	189	47	123,5	118	8	30109910
15,00	2	204	50	124	116	8	30109912
16,00	2	210	52	130	123	8	30109914

Dimensions in mm.

Cutting data see page 367 ff.

Information on special designs and other coatings on request.

Machine reamer I 040420

Configurable series, with Morse taper shank, long cutting section and solid carbide head

Design:

Diameter:

Cutting direction:

Cutting material:

Flute direction:

Geometry:

4,750-16,200 mm

Right-hand cutting

Solid carbide, uncoated

Straight fluted

EU spacing

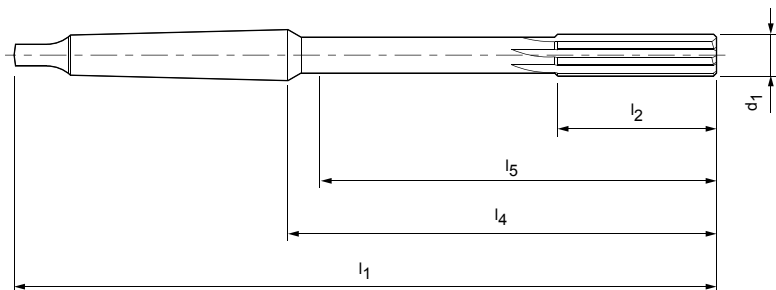

Dimensions						z
d_1	MK	l_1	l_2	l_4	l_5	
4,750-5,300	1	133	23	67,5	57	6
5,301-5,700	1	138	26	72,5	62	6
5,701-6,110	1	138	26	72,5	62	6
6,111-6,700	1	144	28	78,5	69	6
6,701-7,200	1	150	31	84,5	75	6
7,201-7,700	1	150	31	84,5	76	6
7,701-8,200	1	156	33	90,5	82	6
8,201-8,700	1	156	33	90,5	82	6
8,701-9,200	1	162	36	96,5	89	6
9,201-9,700	1	162	36	96,5	89	6
9,701-10,200	1	168	38	102,5	95	6
10,201-10,700	1	168	38	102,5	96	6
10,701-11,700	1	175	41	109,5	104	6
11,701-12,200	1	182	44	116,5	111	6
12,201-13,200	1	182	44	116,5	111	6
13,201-14,200	1	189	47	123,5	118	8
14,201-15,200	2	204	50	124	116	8
15,201-16,200	2	210	52	130	123	8

Dimensions in mm.

Cutting data see page 367 ff.

Information on special designs and other coatings on request.

Machine reamer I 040422

Preferred series with Morse taper shank, long cutting section and solid carbide head

Design:

Diameter: 5,00-16,00 mm
 Cutting direction: Right-hand cutting
 Cutting material: Solid carbide, uncoated
 Flute direction: Spiral fluted
 Geometry: EU spacing

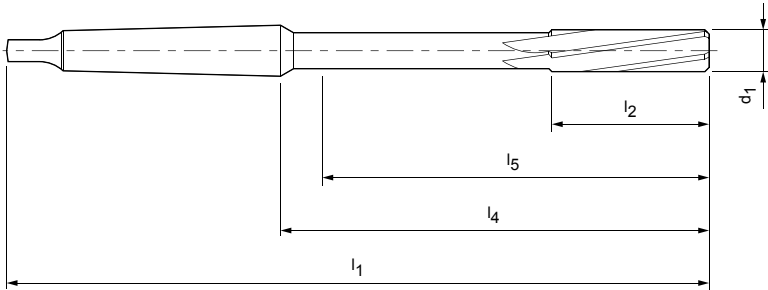

Dimensions						z	Order No.
d_1 H7	MK	l_1	l_2	l_4	l_5		
5,00	1	133	23	67,5	57	6	30109960
5,50	1	138	26	72,5	62	6	30312307
6,00	1	138	26	72,5	62	6	30109962
6,50	1	144	28	78,5	69	6	30312309
7,00	1	150	31	84,5	75	6	30109964
7,50	1	150	31	84,5	76	6	30312310
8,00	1	156	33	90,5	82	6	30109966
8,50	1	156	33	90,5	82	6	30312312
9,00	1	162	36	96,5	89	6	30109968
9,50	1	162	36	96,5	89	6	30312313
10,00	1	168	38	102,5	95	6	30109970
10,50	1	168	38	102,5	96	6	30312316
11,00	1	175	41	109,5	104	6	30109972
12,00	1	182	44	116,5	111	6	30109974
13,00	1	182	44	116,5	111	6	30109976
14,00	1	189	47	123,5	118	8	30109978
15,00	2	204	50	124	116	8	30109980
16,00	2	210	52	130	123	8	30109982

Dimensions in mm.

Cutting data see page 367 ff.

Information on special designs and other coatings on request.

Machine reamer I 040422

Configurable series, with Morse taper shank, long cutting section and solid carbide head

Design:

Diameter:

Cutting direction:

Cutting material:

Flute direction:

Geometry:

4,750-16,200 mm

Right-hand cutting

Solid carbide, uncoated

Spiral fluted

EU spacing

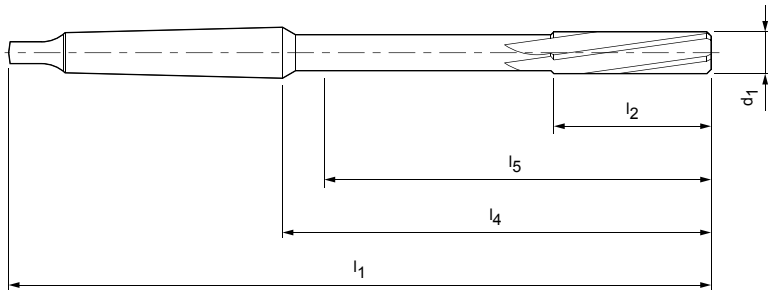

Dimensions						z
d_1	MK	l_1	l_2	l_4	l_5	
4,750-5,300	1	133	23	67,5	57	6
5,301-5,700	1	138	26	72,5	62	6
5,701-6,110	1	138	26	72,5	62	6
6,111-6,700	1	144	28	78,5	69	6
6,701-7,200	1	150	31	84,5	75	6
7,201-7,700	1	150	31	84,5	76	6
7,701-8,200	1	156	33	90,5	82	6
8,201-8,700	1	156	33	90,5	82	6
8,701-9,200	1	162	36	96,5	89	6
9,201-9,700	1	162	36	96,5	89	6
9,701-10,200	1	168	38	102,5	95	6
10,201-10,700	1	168	38	102,5	96	6
10,701-11,700	1	175	41	109,5	104	6
11,701-12,200	1	182	44	116,5	111	6
12,201-13,200	1	182	44	116,5	111	6
13,201-14,200	1	189	47	123,5	118	8
14,201-15,200	2	204	50	124	116	8
15,201-16,200	2	210	52	130	123	8

Dimensions in mm.

Cutting data see page 367 ff.

Information on special designs and other coatings on request.

Machine reamer I 040421

Preferred series with Morse taper shank, long cutting section and brazed blades

Design:

Diameter:

17,00-40,00 mm

Cutting direction:

Right-hand cutting

Cutting material:

Carbide, uncoated

Flute direction:

Straight fluted

Geometry:

EU spacing

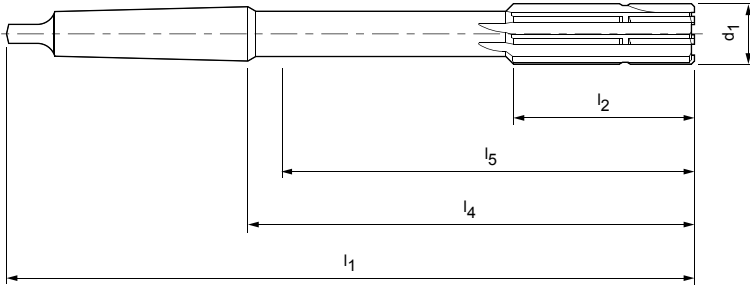

Dimensions						z	Order No.
d_1 H7	MK	l_1	l_2	l_4	l_5		
17,00	2	214	54	134	128	6	30109922
18,00	2	219	56	139	133	6	30109924
19,00	2	223	58	143	137	6	30109926
20,00	2	228	60	148	142	6	30109928
21,00	2	232	62	152	146	6	30109930
22,00	2	237	64	157	151	6	30109932
23,00	2	241	66	161	155	6	30109934
24,00	3	268	68	169	162	8	30109936
25,00	3	268	68	169	162	8	30109938
26,00	3	273	70	174	167	8	30109940
27,00	3	277	71	178	171	8	30109942
28,00	3	277	71	178	171	8	30109944
30,00	3	281	73	182	175	8	30109946
32,00	4	317	77	193	186	8	30109948
34,00	4	321	78	197	190	8	30109950
35,00	4	321	78	197	190	8	30109952
36,00	4	325	79	201	194	8	30109954
38,00	4	329	81	205	198	8	30109956
40,00	4	329	81	205	198	8	30109958

Dimensions in mm.

Cutting data see page 367 ff.

Information on special designs and other coatings on request.

Machine reamer I 040421

Configurable series, with Morse taper shank, long cutting section and brazed blades

Design:

Diameter:

Cutting direction:

Cutting material:

Flute direction:

Geometry:

16,141-40,160 mm

Right-hand cutting

Carbide, uncoated

Straight fluted

EU spacing

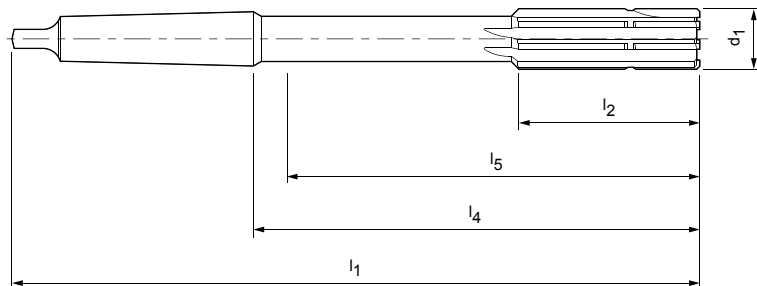

Dimensions*						z
d_1	MK	l_1	l_2	l_4	l_5	
16,141-17,140	2	214	54	134	128	6
17,141-18,140	2	219	56	139	133	6
18,141-19,160	2	223	58	143	137	6
19,161-20,160	2	228	60	148	142	6
20,161-21,200	2	232	62	152	146	6
21,201-22,200	2	237	64	157	151	6
22,201-23,200	2	241	66	161	155	6
23,201-24,200	3	268	68	169	162	8
24,201-25,160	3	268	68	169	162	8
25,161-26,200	3	273	70	174	167	8
26,201-27,200	3	277	71	178	171	8
27,201-28,160	3	277	71	178	171	8
29,201-30,160	3	281	73	182	175	8
31,201-32,200	4	317	77	193	186	8
33,201-34,200	4	321	78	197	190	8
34,201-35,200	4	321	78	197	190	8
35,201-36,200	4	325	79	201	194	8
37,201-38,200	4	329	81	205	198	8
39,201-40,160	4	329	81	205	198	8

Dimensions in mm.

Cutting data see page 367 ff.

Information on special designs and other coatings on request.

(* Intermediate diameters, which are not listed in these tables can be produced as custom design on request.

Machine reamer I 040423

Preferred series, with Morse taper shank, long cutting section and brazed blades

Design:

Diameter:

10,00-40,00 mm

Cutting direction:

Right-hand cutting

Flute direction:

Carbide, uncoated

Flute direction:

Left-hand fluted

Geometry:

EU spacing

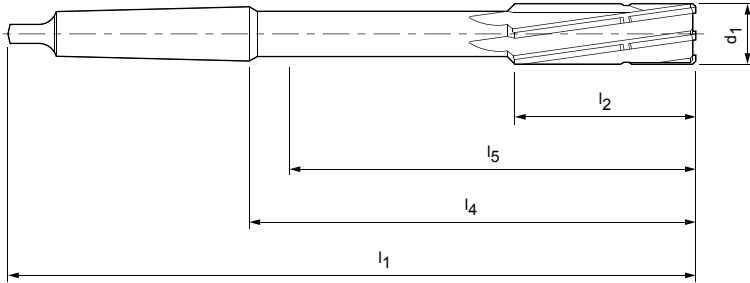

Dimensions						z	Order No.
d_1 H7	MK	l_1	l_2	l_4	l_5		
10,00	1	168	38	102,5	96	6	30109984
10,50	1	168	38	102,5	96	6	30312621
11,00	1	175	41	109,5	103	6	30109986
11,50	1	175	41	109,5	104	6	30312622
12,00	1	182	44	116,5	112	6	30109988
13,00	1	182	44	116,5	112	6	30109990
14,00	1	189	47	123,5	118	6	30109992
15,00	2	204	50	124	116	6	30109994
16,00	2	210	52	130	123	6	30109996
17,00	2	214	54	134	128	6	30109998
18,00	2	219	56	139	133	6	30110000
19,00	2	223	58	143	137	6	30110002
20,00	2	228	60	148	142	6	30110004
21,00	2	232	62	152	146	6	30110006
22,00	2	237	64	157	151	6	30110008
23,00	2	241	66	161	155	6	30110010
24,00	3	268	68	169	162	8	30110012
25,00	3	268	68	169	162	8	30110014
26,00	3	273	70	174	167	8	30110016
27,00	3	277	71	178	171	8	30110018
28,00	3	277	71	178	171	8	30110020
29,00	3	281	73	182	175	8	30312623
30,00	3	281	73	182	175	8	30110022
31,00	3	285	75	186	179	8	30312624
32,00	4	317	77	193	186	8	30110024
34,00	4	321	78	197	190	8	30110026
35,00	4	321	78	197	190	8	30110028
36,00	4	325	79	201	194	8	30110030
38,00	4	329	81	205	198	8	30110032
40,00	4	329	81	205	198	8	30110034

Dimensions in mm.

Cutting data see page 367 ff.

Information on special designs and other coatings on request.

Machine reamer I 040423

Configurable series, with long cutting section and brazed blades

Design:

Diameter:

Cutting direction:

Cutting material:

Flute direction:

Geometry:

9,640-40,160 mm

Right-hand cutting

Carbide, uncoated

Left-hand fluted

EU spacing

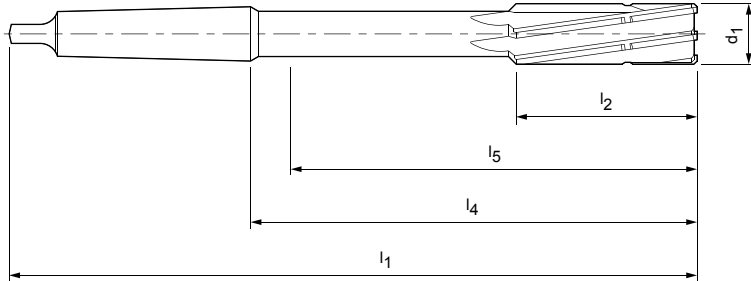

Dimensions*						z
d ₁	MK	l ₁	l ₂	l ₄	l ₅	
9,640-10,200	1	168	38	102,5	96	6
10,201-10,640	1	168	38	102,5	96	6
10,641-11,140	1	175	41	109,5	103	6
11,141-11,800	1	175	41	109,5	104	6
11,801-12,200	1	182	44	116,5	112	6
12,201-13,200	1	182	44	116,5	112	6
13,201-14,140	1	189	47	123,5	118	6
14,141-15,140	2	204	50	124	116	6
15,141-16,140	2	210	52	130	123	6
16,141-17,140	2	214	54	134	128	6
17,141-18,140	2	219	56	139	133	6
18,141-19,160	2	223	58	143	137	6
19,161-20,160	2	228	60	148	142	6
20,161-21,200	2	232	62	152	146	6
21,201-22,200	2	237	64	157	151	6
22,201-23,200	2	241	66	161	155	6
23,201-24,200	3	268	68	169	162	8
24,201-25,160	3	268	68	169	162	8
25,161-26,200	3	273	70	174	167	8
26,201-27,200	3	277	71	178	171	8
27,201-28,160	3	277	71	178	171	8
28,160-29,200	3	281	73	182	175	8
29,201-30,160	3	281	73	182	175	8
30,161-31,200	3	285	75	186	179	8
31,201-32,200	4	317	77	193	186	8
33,201-34,200	4	321	78	197	190	8
34,201-35,200	4	321	78	197	190	8
35,201-36,200	4	325	79	201	194	8
37,201-38,200	4	329	81	205	198	8
39,201-40,160	4	329	81	205	198	8

Dimensions in mm.

Cutting data see page 367 ff.

Information on special designs and other coatings on request.

(*) Intermediate diameters, which are not listed in these tables can be produced as custom design on request.

Machine reamer, expandable I 040311

Preferred series with short cutting section and brazed blades

Design:

Diameter: 8,00-20,00 mm
 Cutting direction: Right-hand cutting
 Cutting material: Carbide, uncoated
 Flute direction: Straight fluted

Special feature:

Expandable by 0,03 mm through front-mounted screw

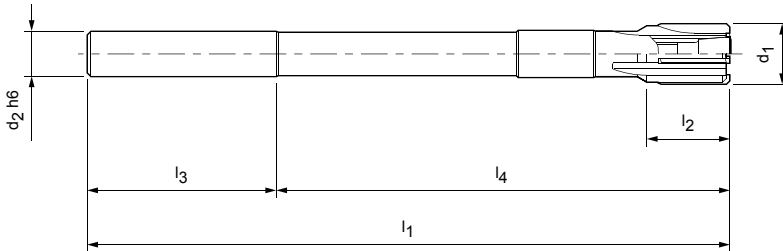

Dimensions						z	Order No.
d_1 H7	d_2 h6	l_1	l_2	l_3	l_4		
8,00	8	117	12	42	75	4	30109517
8,50	8	117	12	42	75	4	30310349
9,00	10	125	12	46	79	6	30109519
9,50	10	125	12	46	79	6	30310350
10,00	10	133	12	46	87	6	30109521
10,50	10	133	12	46	87	6	30310352
11,00	10	142	12	46	96	6	30109523
11,50	10	142	12	46	96	6	30310354
12,00	10	151	12	46	105	6	30109525
12,50	10	151	12	46	105	6	30310361
13,00	10	151	12	46	105	6	30109527
14,00	12	160	16	50	110	6	30109529
15,00	12	162	16	50	112	6	30109531
16,00	12	170	19	50	120	6	30109533
17,00	14	175	19	52	123	6	30310362
18,00	14	182	19	52	130	6	30109535
19,00	16	189	19	58	131	6	30310364
20,00	16	195	19	58	137	6	30109537

Dimensions in mm.

Cutting data see page 367 ff.

Information on special designs and other coatings on request.

Machine reamer, expandable I 040311

Configurable series, with short cutting section and brazed blades

Design:

Diameter: 7,700-20,200 mm
 Cutting direction: Right-hand cutting
 Cutting material: Carbide, uncoated
 Flute direction: Straight fluted

Special feature:

Expandable by 0,03 mm through front-mounted screw

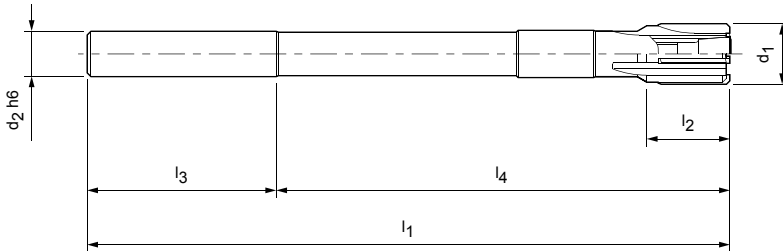

Dimensions						z
d_1	$d_2 h6$	l_1	l_2	l_3	l_4	
7,700-8,200	8	117	12	42	75	4
8,201-8,700	8	117	12	42	75	4
8,701-9,200	10	125	12	46	79	6
9,201-9,700	10	125	12	46	79	6
9,701-10,200	10	133	12	46	87	6
10,201-10,700	10	133	12	46	87	6
10,701-11,200	10	142	12	46	96	6
11,201-11,700	10	142	12	46	96	6
11,701-12,200	10	151	12	46	105	6
12,201-12,700	10	151	12	46	105	6
12,701-13,200	10	151	12	46	105	6
13,201-14,200	12	160	16	50	110	6
14,201-15,200	12	162	16	50	112	6
15,201-16,200	12	170	19	50	120	6
16,201-17,200	14	175	19	52	123	6
17,201-18,200	14	182	19	52	130	6
18,201-19,200	16	189	19	58	131	6
19,201-20,200	16	195	19	58	137	6

Dimensions in mm.

Cutting data see page 367 ff.

Information on special designs and other coatings on request.

Machine reamer, expandable | 040511

Preferred series, with Morse taper shank, short cutting section and brazed blades

Design:

Diameter: 8,00-40,00 mm
 Cutting direction: Right-hand cutting
 Cutting material: Carbide, uncoated
 Flute direction: Straight fluted

Special feature:

Expandable by 0,03 mm through front-mounted screw

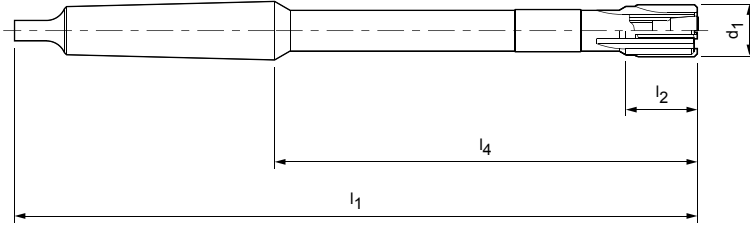

Dimensions					z	Order No.
d_1 H7	MK	l_1	l_2	l_4		
8,00	1	156	12	90,5	4	30110098
8,50	1	156	12	90,5	4	30316589
9,00	1	162	19	96,5	4	30110100
9,50	1	162	12	96,5	6	30316591
10,00	1	168	12	102,5	6	30110102
10,50	1	168	12	102,5	6	30316597
11,00	1	175	12	109,5	6	30110104
11,50	1	175	12	109,5	6	30316598
12,00	1	182	12	116,5	6	30110106
12,50	1	182	12	116,5	6	30316599
13,00	1	182	12	116,5	6	30110108
14,00	1	189	16	123,5	6	30110110
15,00	2	204	16	124	6	30110112
16,00	2	210	19	130	6	30110114
17,00	2	214	19	134	6	30110116
18,00	2	219	19	139	6	30110118
19,00	2	223	19	143	6	30110120
20,00	2	228	19	148	6	30110122
21,00	2	232	19	152	6	30316603
22,00	2	237	22	157	6	30110124
23,00	2	241	22	161	6	30316605
24,00	3	268	22	169	6	30110126
25,00	3	268	22	169	6	30110128
26,00	3	273	22	174	6	30110130
27,00	3	277	25	178	6	30316607
28,00	3	277	25	178	6	30110132
30,00	3	281	25	182	6	30110134
32,00	4	317	25	193	6	30110136
34,00	4	321	25	197	8	30110138
35,00	4	321	25	197	8	30110140
36,00	4	325	25	201	8	30110142
38,00	4	329	25	205	8	30110144
40,00	4	329	25	205	8	30110146

Dimensions in mm.

Cutting data see page 367 ff.

Information on special designs and other coatings on request.

Machine reamer, expandable I 040511

Configurable series, with Morse taper shank, short cutting section and brazed blades

Design:

Diameter: 7,700-40,200 mm
 Cutting direction: Right-hand cutting
 Cutting material: Carbide, uncoated
 Flute direction: Straight fluted

Special feature:

Expandable by 0,03 mm through front-mounted screw

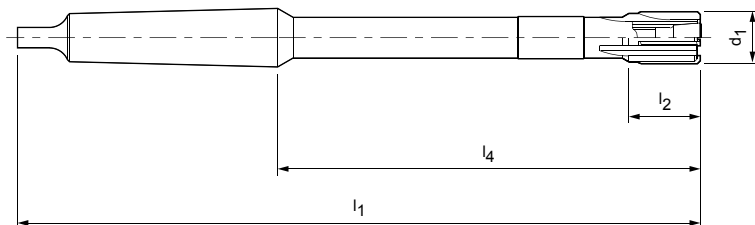

Dimensions*					z
d_1	MK	l_1	l_2	l_4	
7,700-8,200	1	156	12	90,5	4
8,201-8,700	1	156	12	90,5	4
8,701-9,200	1	162	19	96,5	4
9,201-9,700	1	162	12	96,5	6
9,701-10,200	1	168	12	102,5	6
10,201-10,700	1	168	12	102,5	6
10,701-11,200	1	175	12	109,5	6
11,201-11,700	1	175	12	109,5	6
11,701-12,200	1	182	12	116,5	6
12,201-12,700	1	182	12	116,5	6
12,701-13,200	1	182	12	116,5	6
13,201-14,200	1	189	16	123,5	6
14,201-15,200	2	204	16	124	6
15,201-16,200	2	210	19	130	6
16,201-17,200	2	214	19	134	6
17,201-18,200	2	219	19	139	6
18,201-19,200	2	223	19	143	6
19,201-20,200	2	228	19	148	6
20,201-21,200	2	232	19	152	6
21,201-22,200	2	237	22	157	6
22,201-23,200	2	241	22	161	6
23,201-24,200	3	268	22	169	6
24,201-25,200	3	268	22	169	6
25,201-26,200	3	273	22	174	6
26,201-27,200	3	277	25	178	6
27,201-28,200	3	277	25	178	6
29,201-30,200	3	281	25	182	6
31,201-32,200	4	317	25	193	6
33,201-34,200	4	321	25	197	8
34,201-35,200	4	321	25	197	8
35,201-36,200	4	325	25	201	8
37,201-38,200	4	329	25	205	8
39,201-40,200	4	329	25	205	8

Dimensions in mm.

Cutting data see page 367 ff.

Information on special designs and other coatings on request.

(* Intermediate diameters, which are not listed in these tables can be produced as custom design on request.

Machine reamer WN 280 I 040512

Preferred series with Morse taper shank, pre-cutting step and brazed blades

Design:

Diameter: 5,00-40,00 mm
 Cutting direction: Right-hand cutting
 Cutting material: Carbide, uncoated
 Flute direction: Left-hand fluted

Special feature:

At the end of cutting length l_2 , the diameter is ground smaller by 0.3 to 0.4 mm

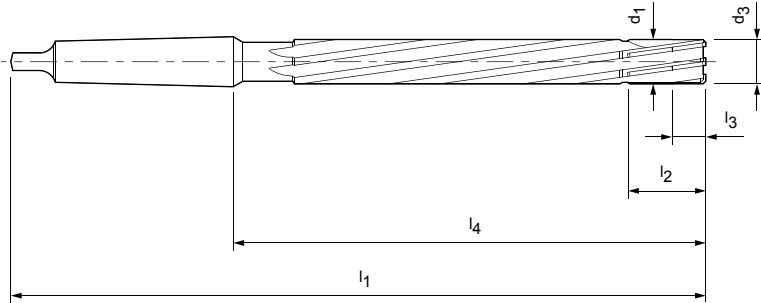

Dimensions*							z	Order No.
d_1 H7	MK	d_3	l_1	l_2	l_3	l_4		
5,00	1	4,92	165	25	10	99,5	6	30110148
6,00	1	5,92	165	25	10	99,5	6	30110149
7,00	1	6,92	185	25	10	119,5	6	30110150
8,00	1	7,92	205	25	10	139,5	6	30110151
9,00	1	8,9	215	23	10	149,5	6	30110152
10,00	1	9,9	230	23	12	164,5	6	30110153
11,00	1	10,9	230	28	12	164,5	6	30110154
12,00	1	11,9	230	28	12	164,5	6	30110155
14,00	1	13,9	230	28	12	164,5	6	30110157
15,00	2	14,9	245	28	12	165	6	30110158
16,00	2	15,9	250	28	12	170	6	30110159
18,00	2	17,9	255	28	12	175	6	30110160
19,00	2	18,9	260	28	12	180	6	30110161
20,00	2	19,9	260	33	15	180	6	30110162
22,00	2	21,85	265	33	15	185	6	30110163
24,00	3	23,85	285	33	15	186	8	30110164
25,00	3	24,85	285	33	15	186	8	30110165
30,00	3	29,85	300	33	15	201	8	30110168
35,00	4	34,85	335	33	15	211	8	30110170
40,00	4	39,85	345	33	15	221	8	30110173

Dimensions in mm.

Cutting data see page 367 ff.

Information on special designs and other coatings on request.

(*) Intermediate diameters and special coatings can be produced as custom design on request.



REAMING WITHOUT INTERNAL COOLING

Machine reamers made of HSS-E

DIN 212-3 B	030505	232
Set DIN 212-3 B	030507	236
DIN 212-1 A / DIN 212-2 A	030510	237
DIN 212-1 B / DIN 212-2 B	030511	239
DIN 212-1 B, TiN coated	033511	243
DIN 212-1 B and DIN 212-2 B	030513	245
DIN 208 A	030110	265
DIN 208 B	030111	267
DIN 208 B, TiN coated	033111	270
DIN 8089 B	030716	272
DIN 212-1 and DIN 212-2, Form C	030610	274
DIN 208, Form C	030310	276
DIN 311	030010	278
WN 141, face cutting	030810	279
WN 142, face cutting	030811	281

NC machine reamer I 030505

Preferred series, with straight shank diameters suitable for direct clamping in hydraulic chucks and high-precision chucks

Design:

Diameter:

1,00-20,00 mm

Cutting direction:

Right-hand cutting

Cutting material:

HSS-E, uncoated

Flute direction:

Spiral fluted

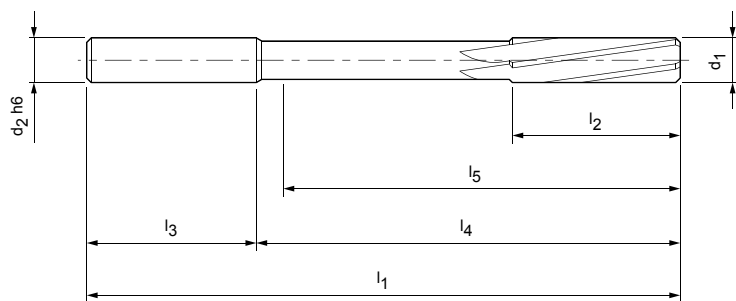

Dimensions								z	Order No.
d ₁	Tolerance	d ₂ h6	l ₁	l ₂	l ₃	l ₄	l ₅		
1,00	H7	1	34	5,5	19	15	12,5	3	30330779
1,01	+0,004	1	34	5,5	19	15	12,5	3	30103146
1,02	+0,004	1	34	5,5	19	15	12,5	3	30103147
1,10	H7	1	36	6,5	20,5	15,5	13	3	10082114
1,20	H7	2	38	7,5	21,5	16,5	14	3	30330781
1,40	H7	2	40	8	22	18	15,5	3	30330783
1,50	H7	2	40	8	22	18	15,5	3	30102976
1,51	+0,004	2	43	9	23	20	16	3	30103149
1,52	+0,004	2	43	9	23	20	16	3	30103150
1,60	H7	2	43	9	23	20	16	3	30102977
1,70	H7	2	43	9	23	20	16	3	30102978
1,80	H7	2	46	10	24	22	19	4	30102979
1,90	H7	2	46	10	24	22	19	4	30102980
1,97	+0,004	2	49	11	25	24	21	4	30103151
1,98	+0,004	2	49	11	25	24	21	4	30103152
1,99	+0,004	2	49	11	25	24	21	4	30103153
2,00	H7	2	49	11	25	24	21	4	30102981
2,01	+0,004	2	49	11	25	24	21	4	30103155
2,02	+0,004	2	49	11	25	24	21	4	30103156
2,10	H7	2	49	11	25	24	21	4	30102982
2,20	H7	3	53	12	28	25	22	4	30102983
2,30	H7	3	53	12	28	25	22	4	30102984
2,40	H7	3	57	14	28	29	26	4	30102985
2,48	+0,004	3	57	14	28	29	26	4	30103157
2,49	+0,004	3	57	14	28	29	26	4	30103158
2,50	H7	3	57	14	28	29	26	4	30102986
2,51	+0,004	3	57	14	28	29	26	4	30103160
2,52	+0,004	3	57	14	28	29	26	4	30103161
2,60	H7	3	57	14	28	29	26	4	30102987
2,70	H7	3	61	15	28	33	30	6	30102988
2,80	H7	3	61	15	28	33	30	6	30102989
2,90	H7	3	61	15	28	33	30	6	30102990
2,97	+0,004	3	61	15	28	33	30	6	30103162
2,98	+0,004	3	61	15	28	33	30	6	30103163
2,99	+0,004	3	61	15	28	33	30	6	30103164
3,00	H7	3	61	15	28	33	30	6	30102991
3,01	+0,004	3	61	15	28	33	30	6	30103166
3,02	+0,004	3	61	15	28	33	30	6	30103167
3,10	H7	4	65	16	28	37	34	6	30102992

NC machine reamer I 030505, preferred series in accordance to DIN 212-3B

Dimensions								z	Order No.
d ₁	Tolerance	d ₂ h6	l ₁	l ₂	l ₃	l ₄	l ₅		
3,20	H7	4	65	16	28	37	34	6	30102993
3,30	H7	4	65	16	28	37	34	6	30102994
3,40	H7	4	70	18	28	42	39	6	30102995
3,50	H7	4	70	18	28	42	39	6	30102996
3,60	H7	4	70	18	28	42	39	6	30102997
3,70	H7	4	70	18	28	42	39	6	30102998
3,80	H7	4	75	19	28	47	44	6	30103000
3,90	H7	4	75	19	28	47	44	6	30103002
3,97	+0,004	4	75	19	28	47	44	6	30103169
3,98	+0,004	4	75	19	28	47	44	6	30103171
3,99	+0,004	4	75	19	28	47	44	6	30103173
4,00	H7	4	75	19	28	47	44	6	30103004
4,01	+0,004	4	75	19	28	47	44	6	30103177
4,02	+0,004	4	75	19	28	47	44	6	30103179
4,10	H7	4	75	19	28	47	44	6	30103006
4,20	H7	4	75	19	28	47	44	6	30103008
4,30	H7	5	80	21	28	52	48	6	30103010
4,40	H7	5	80	21	28	52	48	6	30103012
4,50	H7	5	80	21	28	52	48	6	30103014
4,60	H7	5	80	21	28	52	48	6	30103016
4,70	H7	5	80	21	28	52	48	6	30103018
4,80	H7	5	86	23	28	58	54	6	30103020
4,90	H7	5	86	23	28	58	54	6	30103022
4,97	+0,004	5	86	23	28	58	54	6	30103181
4,98	+0,004	5	86	23	28	58	54	6	30103183
4,99	+0,004	5	86	23	28	58	54	6	30103185
5,00	H7	5	86	23	28	58	54	6	30103024
5,01	+0,004	5	86	23	28	58	54	6	30103189
5,02	+0,004	5	86	23	28	58	54	6	30103191
5,10	H7	5	86	23	28	58	54	6	30103026
5,20	H7	5	86	23	28	58	54	6	30103028
5,30	H7	5	86	23	28	58	54	6	30103030
5,40	H7	6	93	26	36	57	53	6	30103032
5,50	H7	6	93	26	36	57	53	6	30103034
5,60	H7	6	93	26	36	57	53	6	30103036
5,70	H7	6	93	26	36	57	53	6	30103038
5,80	H7	6	93	26	36	57	53	6	30103040
5,90	H7	6	93	26	36	57	53	6	30103042
5,97	+0,005	6	93	26	36	57	53	6	30103193
5,98	+0,005	6	93	26	36	57	53	6	30103195
5,99	+0,005	6	93	26	36	57	53	6	30103197
6,00	H7	6	93	26	36	57	53	6	30103044
6,01	+0,005	6	93	26	36	57	53	6	30103201
6,02	+0,005	6	93	26	36	57	53	6	30103203
6,10	H7	6	101	28	36	65	61	6	30103046
6,20	H7	6	101	28	36	65	61	6	30103048
6,30	H7	6	101	28	36	65	61	6	30103050
6,40	H7	6	101	28	36	65	61	6	30103052
6,50	H7	6	101	28	36	65	61	6	30103054
6,60	H7	6	101	28	36	65	61	6	30103056
6,70	H7	6	101	28	36	65	61	6	30103058
6,80	H7	8	109	31	36	73	69	6	30103060
6,90	H7	8	109	31	36	73	69	6	30103062
7,00	H7	8	109	31	36	73	69	6	30103064
7,10	H7	8	109	31	36	73	69	6	30103066
7,20	H7	8	109	31	36	73	69	6	30103068

Continued on next page.

NC machine reamer I 030505, preferred series in accordance to DIN 212-3B

Dimensions								z	Order No.
d ₁	Tolerance	d ₂ h6	l ₁	l ₂	l ₃	l ₄	l ₅		
7,30	H7	8	109	31	36	73	69	6	30103070
7,40	H7	8	109	31	36	73	69	6	30103072
7,50	H7	8	109	31	36	73	69	6	30103074
7,60	H7	8	117	33	36	81	77	6	30103076
7,70	H7	8	117	33	36	81	77	6	30103078
7,80	H7	8	117	33	36	81	77	6	30103080
7,90	H7	8	117	33	36	81	77	6	30103082
7,97	+0,005	8	117	33	36	81	77	6	30103205
7,98	+0,005	8	117	33	36	81	77	6	30103207
7,99	+0,005	8	117	33	36	81	77	6	30103209
8,00	H7	8	117	33	36	81	77	6	30103084
8,01	+0,005	8	117	33	36	81	77	6	30103213
8,02	+0,005	8	117	33	36	81	77	6	30103215
8,10	H7	8	117	33	36	81	77	6	30103086
8,20	H7	8	117	33	36	81	77	6	30103088
8,30	H7	8	117	33	36	81	77	6	30103090
8,40	H7	8	117	33	36	81	77	6	30103092
8,50	H7	8	117	33	36	81	77	6	30103094
8,60	H7	10	125	36	40	85	81	6	30103096
8,70	H7	10	125	36	40	85	81	6	30103098
8,80	H7	10	125	36	40	85	81	6	30103100
8,90	H7	10	125	36	40	85	81	6	30103102
9,00	H7	10	125	36	40	85	81	6	30103104
9,01	+0,005	10	125	36	40	85	81	6	30103219
9,02	+0,005	10	125	36	40	85	81	6	30103221
9,10	H7	10	125	36	40	85	81	6	30103106
9,20	H7	10	125	36	40	85	81	6	30103108
9,30	H7	10	125	36	40	85	81	6	30103110
9,40	H7	10	125	36	40	85	81	6	30103112
9,50	H7	10	125	36	40	85	81	6	30103114
9,60	H7	10	133	38	40	93	89	6	30103116
9,70	H7	10	133	38	40	93	89	6	30103118
9,80	H7	10	133	38	40	93	89	6	30103120
9,90	H7	10	133	38	40	93	89	6	30103122
9,97	+0,005	10	133	38	40	93	89	6	30103223
9,98	+0,005	10	133	38	40	93	89	6	30103225
9,99	+0,005	10	133	38	40	93	89	6	30103227
10,00	H7	10	133	38	40	93	89	6	30103124
10,01	+0,005	10	133	38	40	93	89	6	30103231
10,02	+0,005	10	133	38	40	93	89	6	30103233
10,50	H7	10	133	38	40	93	89	6	30310463
11,00	H7	10	142	41	40	102	98	6	30103126
11,50	H7	10	142	41	40	102	98	6	30310464
11,97	+0,005	10	151	44	40	111	106	6	30103235
11,98	+0,005	10	151	44	40	111	106	6	30103237
11,99	+0,005	10	151	44	40	111	106	6	30103239
12,00	H7	10	151	44	40	111	106	6	30103128
13,00	H7	10	151	44	40	111	106	6	30103130
14,00	H7	14	160	47	45	115	110	8	30103132
15,00	H7	14	162	50	45	117	112	8	30103134
16,00	H7	14	170	52	45	125	120	8	30103136
17,00	H7	14	175	54	45	130	125	8	30103138
18,00	H7	14	182	56	45	137	132	8	30103140
19,00	H7	16	189	58	48	141	136	8	30103142
20,00	H7	16	195	60	48	147	142	8	30103144

NC machine reamer I 030505

Configurable series, with straight shank diameters suitable for direct clamping in hydraulic chucks and high-precision chucks

Design:

Diameter: 0,950-20,000 mm
 Cutting direction: Right-hand cutting
 Cutting material: HSS-E, uncoated
 Flute direction: Spiral fluted

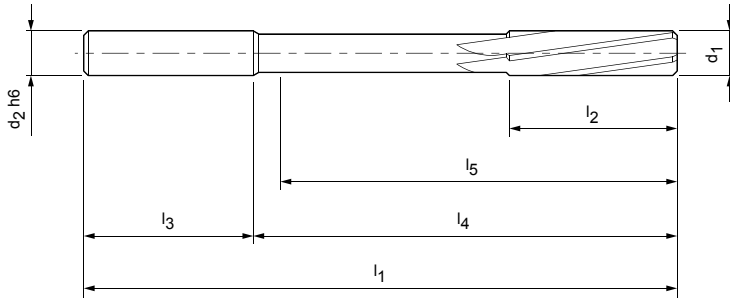

Dimensions							Z
d_1	d_2 h6	l_1	l_2	l_3	l_4	l_5	
0,950-1,060	1	34	5,5	19	15	12,5	3
1,061-1,180	1	36	6,5	20,5	15,5	13	3
1,181-1,320	2	38	7,5	21,5	16,5	14	3
1,321-1,410	2	40	8	22	18	15,5	3
1,411-1,500	2	40	8	22	18	15,5	3
1,501-1,700	2	43	9	23	20	16	3
1,701-1,900	2	46	10	24	22	19	4
1,901-2,120	2	49	11	25	24	21	4
2,121-2,360	3	53	12	28	25	22	4
2,361-2,650	3	57	14	28	29	26	4
2,651-3,030	3	61	15	28	33	30	6
3,031-3,350	4	65	16	28	37	34	6
3,351-3,750	4	70	18	28	42	39	6
3,751-4,250	4	75	19	28	47	44	6
4,251-4,750	5	80	21	28	52	48	6
4,751-5,300	5	86	23	28	58	54	6
5,301-5,600	6	93	26	36	57	53	6
5,601-6,030	6	93	26	36	57	53	6
6,031-6,700	6	101	28	36	65	61	6
6,701-7,200	8	109	31	36	73	69	6
7,201-7,500	8	109	31	36	73	69	6
7,501-8,200	8	117	33	36	81	77	6
8,201-8,500	8	117	33	36	81	77	6
8,501-9,200	10	125	36	40	85	81	6
9,201-9,500	10	125	36	40	85	81	6
9,501-10,200	10	133	38	40	93	89	6
10,201-10,600	10	133	38	40	93	89	6
10,601-11,200	10	142	41	40	102	98	6
11,201-11,800	10	142	41	40	102	98	6
11,801-12,200	10	151	44	40	111	106	6
12,201-13,200	10	151	44	40	111	106	6
13,201-14,000	14	160	47	45	115	110	8
14,001-15,000	14	162	50	45	117	112	8
15,001-16,000	14	170	52	45	125	120	8
16,001-17,000	14	175	54	45	130	125	8
17,001-18,000	14	182	56	45	137	132	8
18,001-19,000	16	189	58	48	141	136	8
19,001-20,000	16	195	60	48	147	142	8

Dimensions in mm.

Cutting data see page 367 ff.

Information on special designs and other coatings on request.

Set NC machine reamer I 030507

10 pieces, with straight shank diameters suitable for direct clamping in hydraulic chucks and high-precision chucks

Design:

Diameter:

1,00-12,00 mm

Cutting direction:

Right-hand cutting

Cutting material:

HSS-E, uncoated

Flute direction:

Spiral fluted

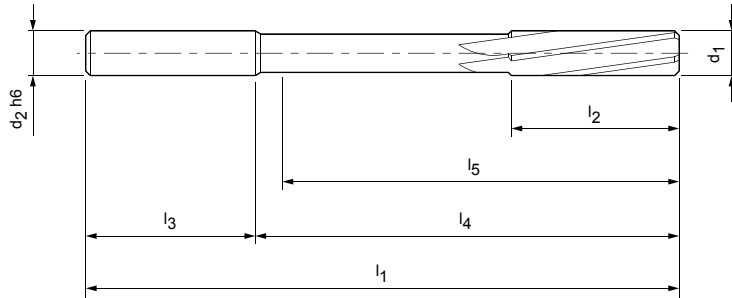

Dimensions							z	Order No.
$d_1 H7$	$d_2 h6$	l_1	l_2	l_3	l_4	l_5		
1,50	2	40	8	22	18	15,5	3	30134724
2,00	2	49	11	25	24	21	4	
3,00	3	61	15	28	33	30	6	
4,00	4	75	19	28	47	44	6	
5,00	5	86	23	28	58	54	6	
6,00	6	93	26	36	57	53	6	
7,00	8	109	31	36	73	69	6	
8,00	8	117	33	36	81	77	6	
10,00	10	133	38	40	93	89	6	
12,00	10	151	44	40	111	106	6	

Machine reamer I 030510

Preferred series

Design:

Diameter: 1,00-20,00 mm
 Cutting direction: Right-hand cutting
 Cutting material: HSS-E, uncoated
 Flute direction: Straight fluted

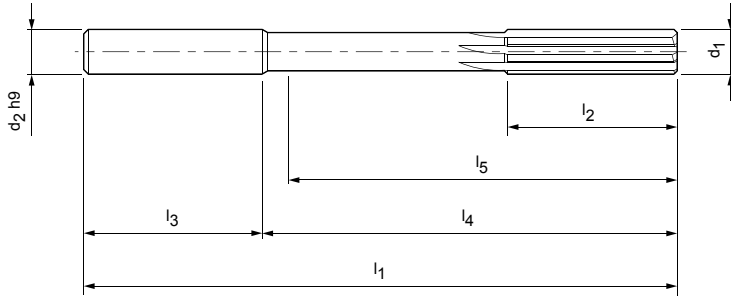

Dimensions							z	Order No.
d_1 H7	d_2 h9	l_1	l_2	l_3	l_4	l_5		
1,00	1	34	5,5	19	15	12,5	3	30103244
1,10	1,1	36	6,5	20,5	15,5	13	3	30103245
1,20	1,2	38	7,5	21,5	16,5	14	3	30103246
1,40	1,4	40	8	22	18	15,5	3	30103248
1,50	1,5	40	8	22	18	15,5	3	30103249
1,60	1,6	43	9	23	20	17,5	3	30103250
1,80	1,8	46	10	24	22	19	4	30103252
2,00	2	49	11	25	24	21	4	30103254
2,20	2,2	53	12	28	25	22	4	30103256
2,50	2,5	57	14	28	29	26	4	30103259
3,00	3	61	15	28	33	30	6	30103264
3,20	3,2	65	16	28	37	34	6	30103266
3,50	3,5	70	18	28	42	39	6	30103269
4,00	4	75	19	28	47	44	6	30103277
4,50	4,5	80	21	28	52	48	6	30103287
5,00	5	86	23	28	58	54	6	30103297
5,50	5,6	93	26	36	57	53	6	30103307
6,00	5,6	93	26	36	57	53	6	30103317
6,50	6,3	101	28	36	65	61	6	30103327
7,00	7,1	109	31	36	73	69	6	30103337
7,50	7,1	109	31	36	73	69	6	30103347
8,00	8	117	33	36	81	77	6	30103357
8,50	8	117	33	36	81	77	6	30103367
9,00	9	125	36	40	85	81	6	30103377
9,50	9	125	36	40	85	81	6	30103385
10,00	10	133	38	40	93	89	6	30103395
10,50	10	133	38	40	93	89	6	30103405
11,00	10	142	41	40	102	98	6	30103411
11,50	10	142	41	40	102	98	6	30103417
12,00	10	151	44	40	111	106	6	30103427
13,00	10	151	44	40	111	106	6	30103429
14,00	12,5	160	47	45	115	110	8	30103431
15,00	12,5	162	50	45	117	112	8	30103433
16,00	12,5	170	52	45	125	120	8	30103435
17,00	14	175	54	45	130	125	8	30103437
18,00	14	182	56	45	137	132	8	30103439
19,00	16	189	58	48	141	136	8	30103441
20,00	16	195	60	48	147	142	8	30103443

Dimensions in mm.

Cutting data see page 367 ff.

Information on special designs and other coatings on request.

Machine reamer I 030510

Configurable series

Design:

Diameter: 0,950-20,000 mm
 Cutting direction: Right-hand cutting
 Cutting material: HSS-E, uncoated
 Flute direction: Straight fluted

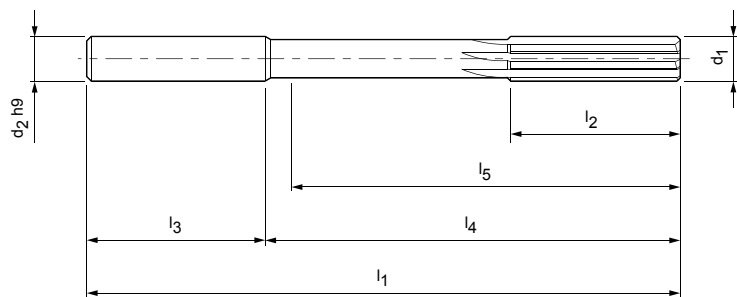

Dimensions							z
d_1	$d_2 h9$	l_1	l_2	l_3	l_4	l_5	
0,950-1,060	1	34	5,5	19	15	12,5	3
1,061-1,180	1,1	36	6,5	20,5	15,5	13	3
1,181-1,320	1,2	38	7,5	21,5	16,5	14	3
1,321-1,410	1,4	40	8	22	18	15,5	3
1,411-1,500	1,5	40	8	22	18	15,5	3
1,501-1,700	1,6	43	9	23	20	17,5	3
1,701-1,900	1,8	46	10	24	22	19	4
1,901-2,120	2	49	11	25	24	21	4
2,121-2,360	2,2	53	12	28	25	22	4
2,361-2,650	2,5	57	14	28	29	26	4
2,651-3,030	3	61	15	28	33	30	6
3,031-3,350	3,2	65	16	28	37	34	6
3,351-3,750	3,5	70	18	28	42	39	6
3,751-4,250	4	75	19	28	47	44	6
4,251-4,750	4,5	80	21	28	52	48	6
4,751-5,300	5	86	23	28	58	54	6
5,301-5,600	5,6	93	26	36	57	53	6
5,601-6,030	5,6	93	26	36	57	53	6
6,031-6,700	6,3	101	28	36	65	61	6
6,701-7,200	7,1	109	31	36	73	69	6
7,201-7,500	7,1	109	31	36	73	69	6
7,501-8,200	8	117	33	36	81	77	6
8,201-8,500	8	117	33	36	81	77	6
8,501-9,200	9	125	36	40	85	81	6
9,201-9,500	9	125	36	40	85	81	6
9,501-10,200	10	133	38	40	93	89	6
10,201-10,600	10	133	38	40	93	89	6
10,601-11,200	10	142	41	40	102	98	6
11,201-11,800	10	142	41	40	102	98	6
11,801-12,200	10	151	44	40	111	106	6
12,201-13,200	10	151	44	40	111	106	6
13,201-14,000	12,5	160	47	45	115	110	8
14,001-15,000	12,5	162	50	45	117	112	8
15,001-16,000	12,5	170	52	45	125	120	8
16,001-17,000	14	175	54	45	130	125	8
17,001-18,000	14	182	56	45	137	132	8
18,001-19,000	16	189	58	48	141	136	8
19,001-20,000	16	195	60	48	147	142	8

Machine reamer I 030511

Preferred series

Design:

Diameter: 1,00-20,00 mm
 Cutting direction: Right-hand cutting
 Cutting material: HSS-E, uncoated
 Flute direction: Spiral fluted

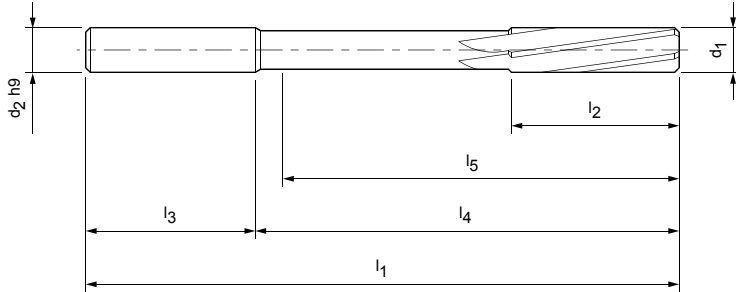

Dimensions							z	Order No.
d_1 H7	d_2 h9	l_1	l_2	l_3	l_4	l_5		
1,00	1	34	5,5	19	15	12,5	3	30103444
1,10	1,1	36	6,5	20,5	15,5	13	3	30103445
1,20	1,2	38	7,5	21,5	16,5	14	3	30103446
1,30	1,2	38	7,5	21,5	16,5	14	3	30103447
1,40	1,4	40	8	22	18	15,5	3	30103448
1,50	1,5	40	8	22	18	15,5	3	30103449
1,60	1,6	43	9	23	20	17,5	3	30103450
1,70	1,6	43	9	23	20	17,5	3	30103451
1,80	1,8	46	10	24	22	19	4	30103452
1,90	1,8	46	10	24	22	19	4	30103453
2,00	2	49	11	25	24	21	4	30103454
2,10	2	49	11	25	24	21	4	30103455
2,20	2,2	53	12	28	25	22	4	30103456
2,30	2,2	53	12	28	25	22	4	30103457
2,40	2,5	57	14	28	29	26	4	30103458
2,50	2,5	57	14	28	29	26	4	30103459
2,60	2,5	57	14	28	29	26	4	30103460
2,70	3	61	15	28	33	30	6	30103461
2,80	3	61	15	28	33	30	6	30103462
2,90	3	61	15	28	33	30	6	30103463
3,00	3	61	15	28	33	30	6	30103464
3,10	3,2	65	16	28	37	34	6	30103465
3,20	3,2	65	16	28	37	34	6	30103466
3,30	3,2	65	16	28	37	34	6	30103467
3,40	3,5	70	18	28	42	39	6	30103468
3,50	3,5	70	18	28	42	39	6	30103469
3,60	3,5	70	18	28	42	39	6	30103470
3,70	3,5	70	18	28	42	39	6	30103471
3,80	4	75	19	28	47	44	6	30103473
3,90	4	75	19	28	47	44	6	30103475
4,00	4	75	19	28	47	44	6	30103477
4,10	4	75	19	28	47	44	6	30103479
4,20	4	75	19	28	47	44	6	30103481
4,30	4,5	80	21	28	52	48	6	30103483
4,40	4,5	80	21	28	52	48	6	30103485
4,50	4,5	80	21	28	52	48	6	30103487
4,60	4,5	80	21	28	52	48	6	30103489
4,70	4,5	80	21	28	52	48	6	30103491
4,80	5	86	23	28	58	54	6	30103493

Machine reamer I 030511, preferred series in accordance to DIN 212-2B

Dimensions							z	Order No.
d ₁ H7	d ₂ h9	l ₁	l ₂	l ₃	l ₄	l ₅		
4,90	5	86	23	28	58	54	6	30103495
5,00	5	86	23	28	58	54	6	30103497
5,10	5	86	23	28	58	54	6	30103499
5,20	5	86	23	28	58	54	6	30103501
5,30	5	86	23	28	58	54	6	30103503
5,40	5,6	93	26	36	57	53	6	30103505
5,50	5,6	93	26	36	57	53	6	30103507
5,60	5,6	93	26	36	57	53	6	30103509
5,70	5,6	93	26	36	57	53	6	30103511
5,80	5,6	93	26	36	57	53	6	30103513
5,90	5,6	93	26	36	57	53	6	30103515
6,00	5,6	93	26	36	57	53	6	30103517
6,10	6,3	101	28	36	65	61	6	30103519
6,20	6,3	101	28	36	65	61	6	30103521
6,30	6,3	101	28	36	65	61	6	30103523
6,40	6,3	101	28	36	65	61	6	30103525
6,50	6,3	101	28	36	65	61	6	30103527
6,60	6,3	101	28	36	65	61	6	30103529
6,70	6,3	101	28	36	65	61	6	30103531
6,80	7,1	109	31	36	73	69	6	30103533
6,90	7,1	109	31	36	73	69	6	30103535
7,00	7,1	109	31	36	73	69	6	30103537
7,10	7,1	109	31	36	73	69	6	30103539
7,20	7,1	109	31	36	73	69	6	30103541
7,30	7,1	109	31	36	73	69	6	30103543
7,40	7,1	109	31	36	73	69	6	30103545
7,50	7,1	109	31	36	73	69	6	30103547
7,60	8	117	33	36	81	77	6	30103549
7,70	8	117	33	36	81	77	6	30103551
7,80	8	117	33	36	81	77	6	30103553
7,90	8	117	33	36	81	77	6	30103555
8,00	8	117	33	36	81	77	6	30103557
8,10	8	117	33	36	81	77	6	30103559
8,20	8	117	33	36	81	77	6	30103561
8,30	8	117	33	36	81	77	6	30103563
8,40	8	117	33	36	81	77	6	30103565
8,50	8	117	33	36	81	77	6	30103567
8,60	9	125	36	40	85	81	6	30103569
8,70	9	125	36	40	85	81	6	30103571
8,80	9	125	36	40	85	81	6	30103573
8,90	9	125	36	40	85	81	6	30103575
9,00	9	125	36	40	85	81	6	30103577
9,10	9	125	36	40	85	81	6	30103579
9,20	9	125	36	40	85	81	6	30103581
9,30	9	125	36	40	85	81	6	30103583
9,40	9	125	36	40	85	81	6	30103585
9,50	9	125	36	40	85	81	6	30103587
9,60	10	133	38	40	93	89	6	30103589
9,70	10	133	38	40	93	89	6	30103591
9,80	10	133	38	40	93	89	6	30103593
9,90	10	133	38	40	93	89	6	30103595
10,00	10	133	38	40	93	89	6	30103597
10,10	10	133	38	40	93	89	6	30103599
10,20	10	133	38	40	93	89	6	30103601
10,30	10	133	38	40	93	89	6	30103603
10,40	10	133	38	40	93	89	6	30103605

Continued on next page.

Machine reamer I 030511, preferred series in accordance to DIN 212-2B

Dimensions							z	Order No.
d ₁ H7	d ₂ h9	l ₁	l ₂	l ₃	l ₄	l ₅		
10,50	10	133	38	40	93	89	6	30103607
10,60	10	133	38	40	93	89	6	30103609
10,70	10	142	41	40	102	98	6	30103611
10,80	10	142	41	40	102	98	6	30103613
10,90	10	142	41	40	102	98	6	30103615
11,00	10	142	41	40	102	98	6	30103617
11,10	10	142	41	40	102	98	6	30103619
11,20	10	142	41	40	102	98	6	30103621
11,30	10	142	41	40	102	98	6	30103623
11,40	10	142	41	40	102	98	6	30103625
11,50	10	142	41	40	102	98	6	30103627
11,60	10	142	41	40	102	98	6	30103629
11,70	10	142	41	40	102	98	6	30103631
11,80	10	142	41	40	102	98	6	30103633
11,90	10	151	44	40	111	106	6	30103635
12,00	10	151	44	40	111	106	6	30103637
13,00	10	151	44	40	111	106	6	30103639
14,00	12,5	160	47	45	115	110	8	30103641
15,00	12,5	162	50	45	117	112	8	30103643
16,00	12,5	170	52	45	125	120	8	30103645
17,00	14	175	54	45	130	125	8	30103647
18,00	14	182	56	45	137	132	8	30103649
19,00	16	189	58	48	141	136	8	30103651
20,00	16	195	60	48	147	142	8	30103653

Dimensions in mm.

Cutting data see page 367 ff.

Information on special designs and other coatings on request.

Machine reamer I 030511

Configurable series

Design:

Diameter: 0,950-20,000 mm
 Cutting direction: Right-hand cutting
 Cutting material: HSS-E, uncoated
 Flute direction: Spiral fluted

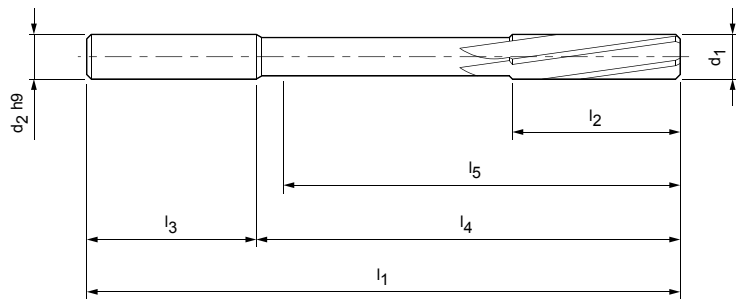

Dimensions							z
d_1	d_2 h9	l_1	l_2	l_3	l_4	l_5	
0,950-1,060	1	34	5,5	19	15	12,5	3
1,061-1,180	1,1	36	6,5	20,5	15,5	13	3
1,181-1,320	1,2	38	7,5	21,5	16,5	14	3
1,321-1,410	1,4	40	8	22	18	15,5	3
1,411-1,500	1,5	40	8	22	18	15,5	3
1,501-1,700	1,6	43	9	23	20	17,5	3
1,701-1,900	1,8	46	10	24	22	19	4
1,901-2,120	2	49	11	25	24	21	4
2,121-2,360	2,2	53	12	28	25	22	4
2,361-2,650	2,5	57	14	28	29	26	4
2,651-3,030	3	61	15	28	33	30	6
3,031-3,350	3,2	65	16	28	37	34	6
3,351-3,750	3,5	70	18	28	42	39	6
3,751-4,250	4	75	19	28	47	44	6
4,251-4,750	4,5	80	21	28	52	48	6
4,751-5,300	5	86	23	28	58	54	6
5,301-5,600	5,6	93	26	36	57	53	6
5,601-6,030	5,6	93	26	36	57	53	6
6,031-6,700	6,3	101	28	36	65	61	6
6,701-7,200	7,1	109	31	36	73	69	6
7,201-7,500	7,1	109	31	36	73	69	6
7,501-8,200	8	117	33	36	81	77	6
8,201-8,500	8	117	33	36	81	77	6
8,501-9,200	9	125	36	40	85	81	6
9,201-9,500	9	125	36	40	85	81	6
9,501-10,200	10	133	38	40	93	89	6
10,201-10,600	10	133	38	40	93	89	6
10,601-11,200	10	142	41	40	102	98	6
11,201-11,800	10	142	41	40	102	98	6
11,801-12,200	10	151	44	40	111	106	6
12,201-13,200	10	151	44	40	111	106	6
13,201-14,000	12,5	160	47	45	115	110	8
14,001-15,000	12,5	162	50	45	117	112	8
15,001-16,000	12,5	170	52	45	125	120	8
16,001-17,000	14	175	54	45	130	125	8
17,001-18,000	14	182	56	45	137	132	8
18,001-19,000	16	189	58	48	141	136	8
19,001-20,000	16	195	60	48	147	142	8

Machine reamer I 033511

Preferred series

Design:

Diameter: 4,00-20,00 mm
 Cutting direction: Right-hand cutting
 Cutting material: HSS-E, TiN coated
 Flute direction: Spiral fluted

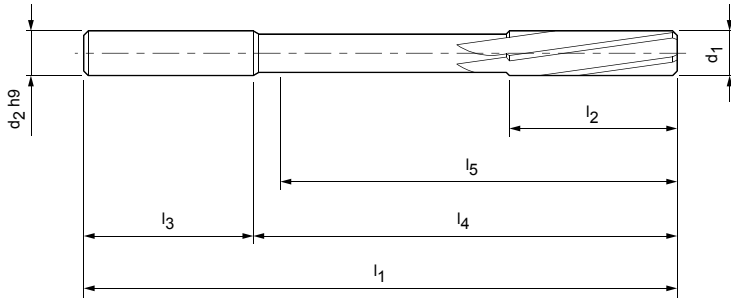

Dimensions							z	Order No.
$d_1 H7$	$d_2 h9$	l_1	l_2	l_3	l_4	l_5		
4,00	4	75	19	28	47	44	6	30107951
5,00	5	86	23	28	58	54	6	30107953
6,00	5,6	93	26	36	57	53	6	30107956
7,00	7,1	109	31	36	73	69	6	30107958
8,00	8	117	33	36	81	77	6	30107960
9,00	9	125	36	40	85	81	6	30107962
10,00	10	133	38	40	93	89	6	30107964
11,00	10	142	41	40	102	98	6	30107966
12,00	10	151	44	40	111	106	6	30107968
13,00	10	151	44	40	111	106	6	30107970
14,00	12,5	160	47	45	115	110	8	30107972
15,00	12,5	162	50	45	117	112	8	30107974
16,00	12,5	170	52	45	125	120	8	30107976
17,00	14	175	54	45	130	125	8	30107978
18,00	14	182	56	45	137	132	8	30107980
19,00	16	189	58	48	141	136	8	30107982
20,00	16	195	60	48	147	142	8	30107984

Dimensions in mm.
 Cutting data see page 367 ff.
 Information on special designs and other coatings on request.

Machine reamer I 033511

Configurable series

Design:

Diameter:

3,751-20,000 mm

Cutting direction:

Right-hand cutting

Cutting material:

HSS-E, TiN coated

Flute direction:

Spiral fluted

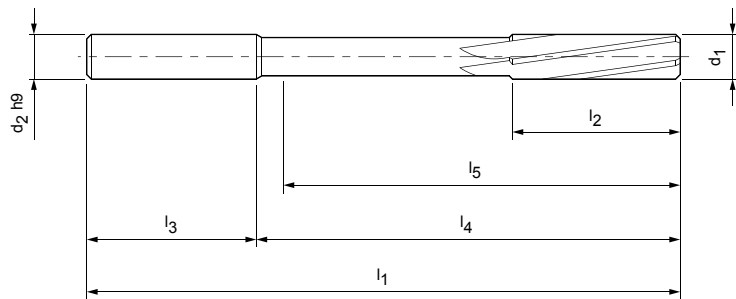

Dimensions							z
d_1	$d_2 h_9$	l_1	l_2	l_3	l_4	l_5	
3,751-4,250	4	75	19	28	47	44	6
4,251-4,750	4,5	80	21	28	52	48	6
4,751-5,300	5	86	23	28	58	54	6
5,301-5,600	5,6	93	26	36	57	53	6
5,601-6,030	5,6	93	26	36	57	53	6
6,031-6,700	6,3	101	28	36	65	61	6
6,701-7,200	7,1	109	31	36	73	69	6
7,201-7,500	7,1	109	31	36	73	69	6
7,501-8,200	8	117	33	36	81	77	6
8,201-8,500	8	117	33	36	81	77	6
8,501-9,200	9	125	36	40	85	81	6
9,201-9,500	9	125	36	40	85	81	6
9,501-10,200	10	133	38	40	93	89	6
10,201-10,600	10	133	38	40	93	89	6
10,601-11,200	10	142	41	40	102	98	6
11,201-11,800	10	142	41	40	102	98	6
11,801-12,200	10	151	44	40	111	106	6
12,201-13,200	10	151	44	40	111	106	6
13,201-14,000	12,5	160	47	45	115	110	8
14,001-15,000	12,5	162	50	45	117	112	8
15,001-16,000	12,5	170	52	45	125	120	8
16,001-17,000	14	175	54	45	130	125	8
17,001-18,000	14	182	56	45	137	132	8
18,001-19,000	16	189	58	48	141	136	8
19,001-20,000	16	195	60	48	147	142	8

Dimensions in mm.

Cutting data see page 367 ff.

Information on special designs and other coatings on request.

Machine reamer I 030513

Preferred series

Design:

Diameter: 0,95-12,05 mm
 Cutting direction: Right-hand cutting
 Cutting material: HSS-E, uncoated
 Flute direction: Spiral fluted

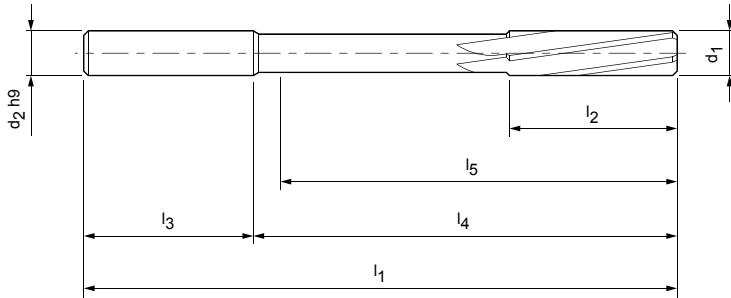

Dimensions								z	Order No.
d ₁	Tolerance	d ₂ h9	l ₁	l ₂	l ₃	l ₄	l ₅		
0,95	+0,004	1	34	5,5	19	15	12,5	3	30103654
0,96	+0,004	1	34	5,5	19	15	12,5	3	30103655
0,97	+0,004	1	34	5,5	19	15	12,5	3	30103656
0,98	+0,004	1	34	5,5	19	15	12,5	3	30103657
0,99	+0,004	1	34	5,5	19	15	12,5	3	30103658
1,00	+0,004	1	34	5,5	19	15	12,5	3	30103659
1,01	+0,004	1	34	5,5	19	15	12,5	3	30103660
1,02	+0,004	1	34	5,5	19	15	12,5	3	30103661
1,03	+0,004	1	34	5,5	19	15	12,5	3	30103662
1,04	+0,004	1	34	5,5	19	15	12,5	3	30103663
1,05	+0,004	1	34	5,5	19	15	12,5	3	30103664
1,06	+0,004	1	34	5,5	19	15	12,5	3	30103665
1,07	+0,004	1,1	36	6,5	20,5	15,5	13	3	30103666
1,08	+0,004	1,1	36	6,5	20,5	15,5	13	3	30103667
1,09	+0,004	1,1	36	6,5	20,5	15,5	13	3	30103668
1,10	+0,004	1,1	36	6,5	20,5	15,5	13	3	30103669
1,11	+0,004	1,1	36	6,5	20,5	15,5	13	3	30103670
1,12	+0,004	1,1	36	6,5	20,5	15,5	13	3	30103671
1,13	+0,004	1,1	36	6,5	20,5	15,5	13	3	30103672
1,14	+0,004	1,1	36	6,5	20,5	15,5	13	3	30103673
1,15	+0,004	1,1	36	6,5	20,5	15,5	13	3	30103674
1,16	+0,004	1,1	36	6,5	20,5	15,5	13	3	30103675
1,17	+0,004	1,1	36	6,5	20,5	15,5	13	3	30103676
1,18	+0,004	1,1	36	6,5	20,5	15,5	13	3	30103677
1,19	+0,004	1,2	38	7,5	21,5	16,5	14	3	30103678
1,20	+0,004	1,2	38	7,5	21,5	16,5	14	3	30103679
1,21	+0,004	1,2	38	7,5	21,5	16,5	14	3	30103680
1,22	+0,004	1,2	38	7,5	21,5	16,5	14	3	30103681
1,23	+0,004	1,2	38	7,5	21,5	16,5	14	3	30103682
1,24	+0,004	1,2	38	7,5	21,5	16,5	14	3	30103683
1,25	+0,004	1,2	38	7,5	21,5	16,5	14	3	30103684
1,26	+0,004	1,2	38	7,5	21,5	16,5	14	3	30103685
1,27	+0,004	1,2	38	7,5	21,5	16,5	14	3	30103686
1,28	+0,004	1,2	38	7,5	21,5	16,5	14	3	30103687
1,29	+0,004	1,2	38	7,5	21,5	16,5	14	3	30103688
1,30	+0,004	1,2	38	7,5	21,5	16,5	14	3	30103689
1,31	+0,004	1,2	38	7,5	21,5	16,5	14	3	30103690
1,32	+0,004	1,2	38	7,5	21,5	16,5	14	3	30103691

Machine reamer I 030513, preferred series in accordance to DIN 212-1, Form B ($\varnothing \leq 3,75$ mm) or DIN 212-2, Form B ($\varnothing \geq 3,76$ mm)

Dimensions								z	Order No.
d ₁	Tolerance	d ₂ h9	l ₁	l ₂	l ₃	l ₄	l ₅		
1,33	+0,004	1,4	40	8	22	18	15,5	3	30103692
1,34	+0,004	1,4	40	8	22	18	15,5	3	30103693
1,35	+0,004	1,4	40	8	22	18	15,5	3	30103694
1,36	+0,004	1,4	40	8	22	18	15,5	3	30103695
1,37	+0,004	1,4	40	8	22	18	15,5	3	30103696
1,38	+0,004	1,4	40	8	22	18	15,5	3	30103697
1,39	+0,004	1,4	40	8	22	18	15,5	3	30103698
1,40	+0,004	1,4	40	8	22	18	15,5	3	30103699
1,41	+0,004	1,4	40	8	22	18	15,5	3	30103700
1,42	+0,004	1,5	40	8	22	18	15,5	3	30103701
1,43	+0,004	1,5	40	8	22	18	15,5	3	30103702
1,44	+0,004	1,5	40	8	22	18	15,5	3	30103703
1,45	+0,004	1,5	40	8	22	18	15,5	3	30103704
1,46	+0,004	1,5	40	8	22	18	15,5	3	30103705
1,47	+0,004	1,5	40	8	22	18	15,5	3	30103706
1,48	+0,004	1,5	40	8	22	18	15,5	3	30103707
1,49	+0,004	1,5	40	8	22	18	15,5	3	30103708
1,50	+0,004	1,5	40	8	22	18	15,5	3	30103709
1,51	+0,004	1,6	43	9	23	20	17,5	3	30103710
1,52	+0,004	1,6	43	9	23	20	17,5	3	30103711
1,53	+0,004	1,6	43	9	23	20	17,5	3	30103712
1,54	+0,004	1,6	43	9	23	20	17,5	3	30103713
1,55	+0,004	1,6	43	9	23	20	17,5	3	30103714
1,56	+0,004	1,6	43	9	23	20	17,5	3	30103715
1,57	+0,004	1,6	43	9	23	20	17,5	3	30103716
1,58	+0,004	1,6	43	9	23	20	17,5	3	30103717
1,59	+0,004	1,6	43	9	23	20	17,5	3	30103718
1,60	+0,004	1,6	43	9	23	20	17,5	3	30103719
1,61	+0,004	1,6	43	9	23	20	17,5	3	30103720
1,62	+0,004	1,6	43	9	23	20	17,5	3	30103721
1,63	+0,004	1,6	43	9	23	20	17,5	3	30103722
1,64	+0,004	1,6	43	9	23	20	17,5	3	30103723
1,65	+0,004	1,6	43	9	23	20	17,5	3	30103724
1,66	+0,004	1,6	43	9	23	20	17,5	3	30103725
1,67	+0,004	1,6	43	9	23	20	17,5	3	30103726
1,68	+0,004	1,6	43	9	23	20	17,5	3	30103727
1,69	+0,004	1,6	43	9	23	20	17,5	3	30103728
1,70	+0,004	1,6	43	9	23	20	17,5	3	30103729
1,71	+0,004	1,8	46	10	24	22	19	4	30103730
1,72	+0,004	1,8	46	10	24	22	19	4	30103731
1,73	+0,004	1,8	46	10	24	22	19	4	30103732
1,74	+0,004	1,8	46	10	24	22	19	4	30103733
1,75	+0,004	1,8	46	10	24	22	19	4	30103734
1,76	+0,004	1,8	46	10	24	22	19	4	30103735
1,77	+0,004	1,8	46	10	24	22	19	4	30103736
1,78	+0,004	1,8	46	10	24	22	19	4	30103737
1,79	+0,004	1,8	46	10	24	22	19	4	30103738
1,80	+0,004	1,8	46	10	24	22	19	4	30103739
1,81	+0,004	1,8	46	10	24	22	19	4	30103740
1,82	+0,004	1,8	46	10	24	22	19	4	30103741
1,83	+0,004	1,8	46	10	24	22	19	4	30103742
1,84	+0,004	1,8	46	10	24	22	19	4	30103743
1,85	+0,004	1,8	46	10	24	22	19	4	30103744
1,86	+0,004	1,8	46	10	24	22	19	4	30103745
1,87	+0,004	1,8	46	10	24	22	19	4	30103746
1,88	+0,004	1,8	46	10	24	22	19	4	30103747
1,89	+0,004	1,8	46	10	24	22	19	4	30103748

Machine reamer I 030513, preferred series in accordance to DIN 212-1, Form B ($\varnothing \leq 3,75$ mm) or DIN 212-2, Form B ($\varnothing \geq 3,76$ mm)

Dimensions								z	Order No.
d ₁	Tolerance	d ₂ h9	l ₁	l ₂	l ₃	l ₄	l ₅		
1,90	+0,004	1,8	46	10	24	22	19	4	30103749
1,91	+0,004	2	49	11	25	24	21	4	30103750
1,92	+0,004	2	49	11	25	24	21	4	30103751
1,93	+0,004	2	49	11	25	24	21	4	30103752
1,94	+0,004	2	49	11	25	24	21	4	30103753
1,95	+0,004	2	49	11	25	24	21	4	30103754
1,96	+0,004	2	49	11	25	24	21	4	30103755
1,97	+0,004	2	49	11	25	24	21	4	30103756
1,98	+0,004	2	49	11	25	24	21	4	30103757
1,99	+0,004	2	49	11	25	24	21	4	30103758
2,00	+0,004	2	49	11	25	24	21	4	30103759
2,01	+0,004	2	49	11	25	24	21	4	30103760
2,02	+0,004	2	49	11	25	24	21	4	30103761
2,03	+0,004	2	49	11	25	24	21	4	30103762
2,04	+0,004	2	49	11	25	24	21	4	30103763
2,05	+0,004	2	49	11	25	24	21	4	30103764
2,06	+0,004	2	49	11	25	24	21	4	30103765
2,07	+0,004	2	49	11	25	24	21	4	30103766
2,08	+0,004	2	49	11	25	24	21	4	30103767
2,09	+0,004	2	49	11	25	24	21	4	30103768
2,10	+0,004	2	49	11	25	24	21	4	30103769
2,11	+0,004	2	49	11	25	24	21	4	30103770
2,12	+0,004	2	49	11	25	24	21	4	30103771
2,13	+0,004	2,2	53	12	28	25	22	4	30103772
2,14	+0,004	2,2	53	12	28	25	22	4	30103773
2,15	+0,004	2,2	53	12	28	25	22	4	30103774
2,16	+0,004	2,2	53	12	28	25	22	4	30103775
2,17	+0,004	2,2	53	12	28	25	22	4	30103776
2,18	+0,004	2,2	53	12	28	25	22	4	30103777
2,19	+0,004	2,2	53	12	28	25	22	4	30103778
2,20	+0,004	2,2	53	12	28	25	22	4	30103779
2,21	+0,004	2,2	53	12	28	25	22	4	30103780
2,22	+0,004	2,2	53	12	28	25	22	4	30103781
2,23	+0,004	2,2	53	12	28	25	22	4	30103782
2,24	+0,004	2,2	53	12	28	25	22	4	30103783
2,25	+0,004	2,2	53	12	28	25	22	4	30103784
2,26	+0,004	2,2	53	12	28	25	22	4	30103785
2,27	+0,004	2,2	53	12	28	25	22	4	30103786
2,28	+0,004	2,2	53	12	28	25	22	4	30103787
2,29	+0,004	2,2	53	12	28	25	22	4	30103788
2,30	+0,004	2,2	53	12	28	25	22	4	30103789
2,31	+0,004	2,2	53	12	28	25	22	4	30103790
2,32	+0,004	2,2	53	12	28	25	22	4	30103791
2,33	+0,004	2,2	53	12	28	25	22	4	30103792
2,34	+0,004	2,2	53	12	28	25	22	4	30103793
2,35	+0,004	2,2	53	12	28	25	22	4	30103794
2,36	+0,004	2,2	53	12	28	25	22	4	30103795
2,37	+0,004	2,5	57	14	28	29	26	4	30103796
2,38	+0,004	2,5	57	14	28	29	26	4	30103797
2,39	+0,004	2,5	57	14	28	29	26	4	30103798
2,40	+0,004	2,5	57	14	28	29	26	4	30103799
2,41	+0,004	2,5	57	14	28	29	26	4	30103800
2,42	+0,004	2,5	57	14	28	29	26	4	30103801
2,43	+0,004	2,5	57	14	28	29	26	4	30103802
2,44	+0,004	2,5	57	14	28	29	26	4	30103803
2,45	+0,004	2,5	57	14	28	29	26	4	30103804

Continued on next page.

Machine reamer I 030513, preferred series in accordance to DIN 212-1, Form B ($\varnothing \leq 3,75$ mm) or DIN 212-2, Form B ($\varnothing \geq 3,76$ mm)

Dimensions								z	Order No.
d ₁	Tolerance	d ₂ h9	l ₁	l ₂	l ₃	l ₄	l ₅		
2,46	+0,004	2,5	57	14	28	29	26	4	30103805
2,47	+0,004	2,5	57	14	28	29	26	4	30103806
2,48	+0,004	2,5	57	14	28	29	26	4	30103807
2,49	+0,004	2,5	57	14	28	29	26	4	30103808
2,50	+0,004	2,5	57	14	28	29	26	4	30103809
2,51	+0,004	2,5	57	14	28	29	26	4	30103810
2,52	+0,004	2,5	57	14	28	29	26	4	30103811
2,53	+0,004	2,5	57	14	28	29	26	4	30103812
2,54	+0,004	2,5	57	14	28	29	26	4	30103813
2,55	+0,004	2,5	57	14	28	29	26	4	30103814
2,56	+0,004	2,5	57	14	28	29	26	4	30103815
2,57	+0,004	2,5	57	14	28	29	26	4	30103816
2,58	+0,004	2,5	57	14	28	29	26	4	30103817
2,59	+0,004	2,5	57	14	28	29	26	4	30103818
2,60	+0,004	2,5	57	14	28	29	26	4	30103819
2,61	+0,004	2,5	57	14	28	29	26	4	30103820
2,62	+0,004	2,5	57	14	28	29	26	4	30103821
2,63	+0,004	2,5	57	14	28	29	26	4	30103822
2,64	+0,004	2,5	57	14	28	29	26	4	30103823
2,65	+0,004	2,5	57	14	28	29	26	4	30103824
2,66	+0,004	3	61	15	28	33	30	6	30103825
2,67	+0,004	3	61	15	28	33	30	6	30103826
2,68	+0,004	3	61	15	28	33	30	6	30103827
2,69	+0,004	3	61	15	28	33	30	6	30103828
2,70	+0,004	3	61	15	28	33	30	6	30103829
2,71	+0,004	3	61	15	28	33	30	6	30103830
2,72	+0,004	3	61	15	28	33	30	6	30103831
2,73	+0,004	3	61	15	28	33	30	6	30103832
2,74	+0,004	3	61	15	28	33	30	6	30103833
2,75	+0,004	3	61	15	28	33	30	6	30103834
2,76	+0,004	3	61	15	28	33	30	6	30103835
2,77	+0,004	3	61	15	28	33	30	6	30103836
2,78	+0,004	3	61	15	28	33	30	6	30103837
2,79	+0,004	3	61	15	28	33	30	6	30103838
2,80	+0,004	3	61	15	28	33	30	6	30103839
2,81	+0,004	3	61	15	28	33	30	6	30103840
2,82	+0,004	3	61	15	28	33	30	6	30103841
2,83	+0,004	3	61	15	28	33	30	6	30103842
2,84	+0,004	3	61	15	28	33	30	6	30103843
2,85	+0,004	3	61	15	28	33	30	6	30103844
2,86	+0,004	3	61	15	28	33	30	6	30103845
2,87	+0,004	3	61	15	28	33	30	6	30103846
2,88	+0,004	3	61	15	28	33	30	6	30103847
2,89	+0,004	3	61	15	28	33	30	6	30103848
2,90	+0,004	3	61	15	28	33	30	6	30103849
2,91	+0,004	3	61	15	28	33	30	6	30103850
2,92	+0,004	3	61	15	28	33	30	6	30103851
2,93	+0,004	3	61	15	28	33	30	6	30103852
2,94	+0,004	3	61	15	28	33	30	6	30103853
2,95	+0,004	3	61	15	28	33	30	6	30103854
2,96	+0,004	3	61	15	28	33	30	6	30103855
2,97	+0,004	3	61	15	28	33	30	6	30103856
2,98	+0,004	3	61	15	28	33	30	6	30103857
2,99	+0,004	3	61	15	28	33	30	6	30103858
3,00	+0,004	3	61	15	28	33	30	6	30103859
3,01	+0,004	3	61	15	28	33	30	6	30103860
3,02	+0,004	3	61	15	28	33	30	6	30103861

Machine reamer I 030513, preferred series in accordance to DIN 212-1, Form B ($\varnothing \leq 3,75$ mm) or DIN 212-2, Form B ($\varnothing \geq 3,76$ mm)

Dimensions								z	Order No.
d ₁	Tolerance	d ₂ h9	l ₁	l ₂	l ₃	l ₄	l ₅		
3,03	+0,004	3	61	15	28	33	30	6	30103862
3,04	+0,004	3,2	65	16	28	37	34	6	30103863
3,05	+0,004	3,2	65	16	28	37	34	6	30103864
3,06	+0,004	3,2	65	16	28	37	34	6	30103865
3,07	+0,004	3,2	65	16	28	37	34	6	30103866
3,08	+0,004	3,2	65	16	28	37	34	6	30103867
3,09	+0,004	3,2	65	16	28	37	34	6	30103868
3,10	+0,004	3,2	65	16	28	37	34	6	30103869
3,11	+0,004	3,2	65	16	28	37	34	6	30103870
3,12	+0,004	3,2	65	16	28	37	34	6	30103871
3,13	+0,004	3,2	65	16	28	37	34	6	30103872
3,14	+0,004	3,2	65	16	28	37	34	6	30103873
3,15	+0,004	3,2	65	16	28	37	34	6	30103874
3,16	+0,004	3,2	65	16	28	37	34	6	30103875
3,17	+0,004	3,2	65	16	28	37	34	6	30103876
3,18	+0,004	3,2	65	16	28	37	34	6	30103877
3,19	+0,004	3,2	65	16	28	37	34	6	30103878
3,20	+0,004	3,2	65	16	28	37	34	6	30103879
3,21	+0,004	3,2	65	16	28	37	34	6	30103880
3,22	+0,004	3,2	65	16	28	37	34	6	30103881
3,23	+0,004	3,2	65	16	28	37	34	6	30103882
3,24	+0,004	3,2	65	16	28	37	34	6	30103883
3,25	+0,004	3,2	65	16	28	37	34	6	30103884
3,26	+0,004	3,2	65	16	28	37	34	6	30103885
3,27	+0,004	3,2	65	16	28	37	34	6	30103886
3,28	+0,004	3,2	65	16	28	37	34	6	30103887
3,29	+0,004	3,2	65	16	28	37	34	6	30103888
3,30	+0,004	3,2	65	16	28	37	34	6	30103889
3,31	+0,004	3,2	65	16	28	37	34	6	30103890
3,32	+0,004	3,2	65	16	28	37	34	6	30103891
3,33	+0,004	3,2	65	16	28	37	34	6	30103892
3,34	+0,004	3,2	65	16	28	37	34	6	30103893
3,35	+0,004	3,2	65	16	28	37	34	6	30103894
3,36	+0,004	3,5	70	18	28	42	39	6	30103895
3,37	+0,004	3,5	70	18	28	42	39	6	30103896
3,38	+0,004	3,5	70	18	28	42	39	6	30103897
3,39	+0,004	3,5	70	18	28	42	39	6	30103898
3,40	+0,004	3,5	70	18	28	42	39	6	30103899
3,41	+0,004	3,5	70	18	28	42	39	6	30103900
3,42	+0,004	3,5	70	18	28	42	39	6	30103901
3,43	+0,004	3,5	70	18	28	42	39	6	30103902
3,44	+0,004	3,5	70	18	28	42	39	6	30103903
3,45	+0,004	3,5	70	18	28	42	39	6	30103904
3,46	+0,004	3,5	70	18	28	42	39	6	30103905
3,47	+0,004	3,5	70	18	28	42	39	6	30103906
3,48	+0,004	3,5	70	18	28	42	39	6	30103907
3,49	+0,004	3,5	70	18	28	42	39	6	30103908
3,50	+0,004	3,5	70	18	28	42	39	6	30103909
3,51	+0,004	3,5	70	18	28	42	39	6	30103910
3,52	+0,004	3,5	70	18	28	42	39	6	30103911
3,53	+0,004	3,5	70	18	28	42	39	6	30103912
3,54	+0,004	3,5	70	18	28	42	39	6	30103913
3,55	+0,004	3,5	70	18	28	42	39	6	30103914
3,56	+0,004	3,5	70	18	28	42	39	6	30103915
3,57	+0,004	3,5	70	18	28	42	39	6	30103916
3,58	+0,004	3,5	70	18	28	42	39	6	30103917

Continued on next page.

Machine reamer I 030513, preferred series in accordance to DIN 212-1, Form B ($\varnothing \leq 3,75$ mm) or DIN 212-2, Form B ($\varnothing \geq 3,76$ mm)

Dimensions								z	Order No.
d ₁	Tolerance	d ₂ h9	l ₁	l ₂	l ₃	l ₄	l ₅		
3,59	+0,004	3,5	70	18	28	42	39	6	30103918
3,60	+0,004	3,5	70	18	28	42	39	6	30103919
3,61	+0,004	3,5	70	18	28	42	39	6	30103920
3,62	+0,004	3,5	70	18	28	42	39	6	30103921
3,63	+0,004	3,5	70	18	28	42	39	6	30103922
3,64	+0,004	3,5	70	18	28	42	39	6	30103923
3,65	+0,004	3,5	70	18	28	42	39	6	30103924
3,66	+0,004	3,5	70	18	28	42	39	6	30103925
3,67	+0,004	3,5	70	18	28	42	39	6	30103926
3,68	+0,004	3,5	70	18	28	42	39	6	30103927
3,69	+0,004	3,5	70	18	28	42	39	6	30103928
3,70	+0,004	3,5	70	18	28	42	39	6	30103929
3,71	+0,004	3,5	70	18	28	42	39	6	30103930
3,72	+0,004	3,5	70	18	28	42	39	6	30103931
3,73	+0,004	3,5	70	18	28	42	39	6	30103932
3,74	+0,004	3,5	70	18	28	42	39	6	30103933
3,75	+0,004	3,5	70	18	28	42	39	6	30103934
3,76	+0,004	4	75	19	28	47	44	6	30103936
3,77	+0,004	4	75	19	28	47	44	6	30103938
3,78	+0,004	4	75	19	28	47	44	6	30103940
3,79	+0,004	4	75	19	28	47	44	6	30103942
3,80	+0,004	4	75	19	28	47	44	6	30103944
3,81	+0,004	4	75	19	28	47	44	6	30103946
3,82	+0,004	4	75	19	28	47	44	6	30103948
3,83	+0,004	4	75	19	28	47	44	6	30103950
3,84	+0,004	4	75	19	28	47	44	6	30103952
3,85	+0,004	4	75	19	28	47	44	6	30103954
3,86	+0,004	4	75	19	28	47	44	6	30103956
3,87	+0,004	4	75	19	28	47	44	6	30103958
3,88	+0,004	4	75	19	28	47	44	6	30103960
3,89	+0,004	4	75	19	28	47	44	6	30103962
3,90	+0,004	4	75	19	28	47	44	6	30103964
3,91	+0,004	4	75	19	28	47	44	6	30103966
3,92	+0,004	4	75	19	28	47	44	6	30103968
3,93	+0,004	4	75	19	28	47	44	6	30103970
3,94	+0,004	4	75	19	28	47	44	6	30103972
3,95	+0,004	4	75	19	28	47	44	6	30103974
3,96	+0,004	4	75	19	28	47	44	6	30103976
3,97	+0,004	4	75	19	28	47	44	6	30103978
3,98	+0,004	4	75	19	28	47	44	6	30103980
3,99	+0,004	4	75	19	28	47	44	6	30103982
4,00	+0,004	4	75	19	28	47	44	6	30103984
4,01	+0,004	4	75	19	28	47	44	6	30103986
4,02	+0,004	4	75	19	28	47	44	6	30103988
4,03	+0,004	4	75	19	28	47	44	6	30103990
4,04	+0,004	4	75	19	28	47	44	6	30103992
4,05	+0,004	4	75	19	28	47	44	6	30103994
4,06	+0,004	4	75	19	28	47	44	6	30103996
4,07	+0,004	4	75	19	28	47	44	6	30103998
4,08	+0,004	4	75	19	28	47	44	6	30104000
4,09	+0,004	4	75	19	28	47	44	6	30104002
4,10	+0,004	4	75	19	28	47	44	6	30104004
4,11	+0,004	4	75	19	28	47	44	6	30104006
4,12	+0,004	4	75	19	28	47	44	6	30104008
4,13	+0,004	4	75	19	28	47	44	6	30104010
4,14	+0,004	4	75	19	28	47	44	6	30104012
4,15	+0,004	4	75	19	28	47	44	6	30104014

Machine reamer I 030513, preferred series in accordance to DIN 212-1, Form B ($\varnothing \leq 3,75$ mm) or DIN 212-2, Form B ($\varnothing \geq 3,76$ mm)

Dimensions								z	Order No.
d ₁	Tolerance	d ₂ h9	l ₁	l ₂	l ₃	l ₄	l ₅		
4,16	+0,004	4	75	19	28	47	44	6	30104016
4,17	+0,004	4	75	19	28	47	44	6	30104018
4,18	+0,004	4	75	19	28	47	44	6	30104020
4,19	+0,004	4	75	19	28	47	44	6	30104022
4,20	+0,004	4	75	19	28	47	44	6	30104024
4,21	+0,004	4	75	19	28	47	44	6	30104026
4,22	+0,004	4	75	19	28	47	44	6	30104028
4,23	+0,004	4	75	19	28	47	44	6	30104030
4,24	+0,004	4	75	19	28	47	44	6	30104032
4,25	+0,004	4	75	19	28	47	44	6	30104034
4,26	+0,004	4,5	80	21	28	52	48	6	30104036
4,27	+0,004	4,5	80	21	28	52	48	6	30104038
4,28	+0,004	4,5	80	21	28	52	48	6	30104040
4,29	+0,004	4,5	80	21	28	52	48	6	30104042
4,30	+0,004	4,5	80	21	28	52	48	6	30104044
4,31	+0,004	4,5	80	21	28	52	48	6	30104046
4,32	+0,004	4,5	80	21	28	52	48	6	30104048
4,33	+0,004	4,5	80	21	28	52	48	6	30104050
4,34	+0,004	4,5	80	21	28	52	48	6	30104052
4,35	+0,004	4,5	80	21	28	52	48	6	30104054
4,36	+0,004	4,5	80	21	28	52	48	6	30104056
4,37	+0,004	4,5	80	21	28	52	48	6	30104058
4,38	+0,004	4,5	80	21	28	52	48	6	30104060
4,39	+0,004	4,5	80	21	28	52	48	6	30104062
4,40	+0,004	4,5	80	21	28	52	48	6	30104064
4,41	+0,004	4,5	80	21	28	52	48	6	30104066
4,42	+0,004	4,5	80	21	28	52	48	6	30104068
4,43	+0,004	4,5	80	21	28	52	48	6	30104070
4,44	+0,004	4,5	80	21	28	52	48	6	30104072
4,45	+0,004	4,5	80	21	28	52	48	6	30104074
4,46	+0,004	4,5	80	21	28	52	48	6	30104076
4,47	+0,004	4,5	80	21	28	52	48	6	30104078
4,48	+0,004	4,5	80	21	28	52	48	6	30104080
4,49	+0,004	4,5	80	21	28	52	48	6	30104082
4,50	+0,004	4,5	80	21	28	52	48	6	30104084
4,51	+0,004	4,5	80	21	28	52	48	6	30104086
4,52	+0,004	4,5	80	21	28	52	48	6	30104088
4,53	+0,004	4,5	80	21	28	52	48	6	30104090
4,54	+0,004	4,5	80	21	28	52	48	6	30104092
4,55	+0,004	4,5	80	21	28	52	48	6	30104094
4,56	+0,004	4,5	80	21	28	52	48	6	30104096
4,57	+0,004	4,5	80	21	28	52	48	6	30104098
4,58	+0,004	4,5	80	21	28	52	48	6	30104100
4,59	+0,004	4,5	80	21	28	52	48	6	30104102
4,60	+0,004	4,5	80	21	28	52	48	6	30104104
4,61	+0,004	4,5	80	21	28	52	48	6	30104106
4,62	+0,004	4,5	80	21	28	52	48	6	30104108
4,63	+0,004	4,5	80	21	28	52	48	6	30104110
4,64	+0,004	4,5	80	21	28	52	48	6	30104112
4,65	+0,004	4,5	80	21	28	52	48	6	30104114
4,66	+0,004	4,5	80	21	28	52	48	6	30104116
4,67	+0,004	4,5	80	21	28	52	48	6	30104118
4,68	+0,004	4,5	80	21	28	52	48	6	30104120
4,69	+0,004	4,5	80	21	28	52	48	6	30104122
4,70	+0,004	4,5	80	21	28	52	48	6	30104124
4,71	+0,004	4,5	80	21	28	52	48	6	30104126

Continued on next page.

Machine reamer I 030513, preferred series in accordance to DIN 212-1, Form B ($\varnothing \leq 3,75$ mm) or DIN 212-2, Form B ($\varnothing \geq 3,76$ mm)

Dimensions								z	Order No.
d ₁	Tolerance	d ₂ h9	l ₁	l ₂	l ₃	l ₄	l ₅		
4,72	+0,004	4,5	80	21	28	52	48	6	30104128
4,73	+0,004	4,5	80	21	28	52	48	6	30104130
4,74	+0,004	4,5	80	21	28	52	48	6	30104132
4,75	+0,004	4,5	80	21	28	52	48	6	30104134
4,76	+0,004	5	86	23	28	58	54	6	30104136
4,77	+0,004	5	86	23	28	58	54	6	30104138
4,78	+0,004	5	86	23	28	58	54	6	30104140
4,79	+0,004	5	86	23	28	58	54	6	30104142
4,80	+0,004	5	86	23	28	58	54	6	30104144
4,81	+0,004	5	86	23	28	58	54	6	30104146
4,82	+0,004	5	86	23	28	58	54	6	30104148
4,83	+0,004	5	86	23	28	58	54	6	30104150
4,84	+0,004	5	86	23	28	58	54	6	30104152
4,85	+0,004	5	86	23	28	58	54	6	30104154
4,86	+0,004	5	86	23	28	58	54	6	30104156
4,87	+0,004	5	86	23	28	58	54	6	30104158
4,88	+0,004	5	86	23	28	58	54	6	30104160
4,89	+0,004	5	86	23	28	58	54	6	30104162
4,90	+0,004	5	86	23	28	58	54	6	30104164
4,91	+0,004	5	86	23	28	58	54	6	30104166
4,92	+0,004	5	86	23	28	58	54	6	30104168
4,93	+0,004	5	86	23	28	58	54	6	30104170
4,94	+0,004	5	86	23	28	58	54	6	30104172
4,95	+0,004	5	86	23	28	58	54	6	30104174
4,96	+0,004	5	86	23	28	58	54	6	30104176
4,97	+0,004	5	86	23	28	58	54	6	30104178
4,98	+0,004	5	86	23	28	58	54	6	30104180
4,99	+0,004	5	86	23	28	58	54	6	30104182
5,00	+0,004	5	86	23	28	58	54	6	30104184
5,01	+0,004	5	86	23	28	58	54	6	30104186
5,02	+0,004	5	86	23	28	58	54	6	30104188
5,03	+0,004	5	86	23	28	58	54	6	30104190
5,04	+0,004	5	86	23	28	58	54	6	30104192
5,05	+0,004	5	86	23	28	58	54	6	30104194
5,06	+0,004	5	86	23	28	58	54	6	30104196
5,07	+0,004	5	86	23	28	58	54	6	30104198
5,08	+0,004	5	86	23	28	58	54	6	30104200
5,09	+0,004	5	86	23	28	58	54	6	30104202
5,10	+0,004	5	86	23	28	58	54	6	30104204
5,11	+0,004	5	86	23	28	58	54	6	30104206
5,12	+0,004	5	86	23	28	58	54	6	30104208
5,13	+0,004	5	86	23	28	58	54	6	30104210
5,14	+0,004	5	86	23	28	58	54	6	30104212
5,15	+0,004	5	86	23	28	58	54	6	30104214
5,16	+0,004	5	86	23	28	58	54	6	30104216
5,17	+0,004	5	86	23	28	58	54	6	30104218
5,18	+0,004	5	86	23	28	58	54	6	30104220
5,19	+0,004	5	86	23	28	58	54	6	30104222
5,20	+0,004	5	86	23	28	58	54	6	30104224
5,21	+0,004	5	86	23	28	58	54	6	30104226
5,22	+0,004	5	86	23	28	58	54	6	30104228
5,23	+0,004	5	86	23	28	58	54	6	30104230
5,24	+0,004	5	86	23	28	58	54	6	30104232
5,25	+0,004	5	86	23	28	58	54	6	30104234
5,26	+0,004	5	86	23	28	58	54	6	30104236
5,27	+0,004	5	86	23	28	58	54	6	30104238
5,28	+0,004	5	86	23	28	58	54	6	30104240

Machine reamer I 030513, preferred series in accordance to DIN 212-1, Form B ($\varnothing \leq 3,75$ mm) or DIN 212-2, Form B ($\varnothing \geq 3,76$ mm)

Dimensions								z	Order No.
d ₁	Tolerance	d ₂ h9	l ₁	l ₂	l ₃	l ₄	l ₅		
5,29	+0,004	5	86	23	28	58	54	6	30104242
5,30	+0,004	5	86	23	28	58	54	6	30104244
5,31	+0,004	5,6	93	26	36	57	53	6	30104246
5,32	+0,004	5,6	93	26	36	57	53	6	30104248
5,33	+0,004	5,6	93	26	36	57	53	6	30104250
5,34	+0,004	5,6	93	26	36	57	53	6	30104252
5,35	+0,004	5,6	93	26	36	57	53	6	30104254
5,36	+0,004	5,6	93	26	36	57	53	6	30104256
5,37	+0,004	5,6	93	26	36	57	53	6	30104258
5,38	+0,004	5,6	93	26	36	57	53	6	30104260
5,39	+0,004	5,6	93	26	36	57	53	6	30104262
5,40	+0,004	5,6	93	26	36	57	53	6	30104264
5,41	+0,004	5,6	93	26	36	57	53	6	30104266
5,42	+0,004	5,6	93	26	36	57	53	6	30104268
5,43	+0,004	5,6	93	26	36	57	53	6	30104270
5,44	+0,004	5,6	93	26	36	57	53	6	30104272
5,45	+0,004	5,6	93	26	36	57	53	6	30104274
5,46	+0,004	5,6	93	26	36	57	53	6	30104276
5,47	+0,004	5,6	93	26	36	57	53	6	30104278
5,48	+0,004	5,6	93	26	36	57	53	6	30104280
5,49	+0,004	5,6	93	26	36	57	53	6	30104282
5,50	+0,004	5,6	93	26	36	57	53	6	30104284
5,51	+0,005	5,6	93	26	36	57	53	6	30104286
5,52	+0,005	5,6	93	26	36	57	53	6	30104288
5,53	+0,005	5,6	93	26	36	57	53	6	30104290
5,54	+0,005	5,6	93	26	36	57	53	6	30104292
5,55	+0,005	5,6	93	26	36	57	53	6	30104294
5,56	+0,005	5,6	93	26	36	57	53	6	30104296
5,57	+0,005	5,6	93	26	36	57	53	6	30104298
5,58	+0,005	5,6	93	26	36	57	53	6	30104300
5,59	+0,005	5,6	93	26	36	57	53	6	30104302
5,60	+0,005	5,6	93	26	36	57	53	6	30104304
5,61	+0,005	5,6	93	26	36	57	53	6	30104306
5,62	+0,005	5,6	93	26	36	57	53	6	30104308
5,63	+0,005	5,6	93	26	36	57	53	6	30104310
5,64	+0,005	5,6	93	26	36	57	53	6	30104312
5,65	+0,005	5,6	93	26	36	57	53	6	30104314
5,66	+0,005	5,6	93	26	36	57	53	6	30104316
5,67	+0,005	5,6	93	26	36	57	53	6	30104318
5,68	+0,005	5,6	93	26	36	57	53	6	30104320
5,69	+0,005	5,6	93	26	36	57	53	6	30104322
5,70	+0,005	5,6	93	26	36	57	53	6	30104324
5,71	+0,005	5,6	93	26	36	57	53	6	30104326
5,72	+0,005	5,6	93	26	36	57	53	6	30104328
5,73	+0,005	5,6	93	26	36	57	53	6	30104330
5,74	+0,005	5,6	93	26	36	57	53	6	30104332
5,75	+0,005	5,6	93	26	36	57	53	6	30104334
5,76	+0,005	5,6	93	26	36	57	53	6	30104336
5,77	+0,005	5,6	93	26	36	57	53	6	30104338
5,78	+0,005	5,6	93	26	36	57	53	6	30104340
5,79	+0,005	5,6	93	26	36	57	53	6	30104342
5,80	+0,005	5,6	93	26	36	57	53	6	30104344
5,81	+0,005	5,6	93	26	36	57	53	6	30104346
5,82	+0,005	5,6	93	26	36	57	53	6	30104348
5,83	+0,005	5,6	93	26	36	57	53	6	30104350
5,84	+0,005	5,6	93	26	36	57	53	6	30104352

Continued on next page.

Machine reamer I 030513, preferred series in accordance to DIN 212-1, Form B ($\varnothing \leq 3,75$ mm) or DIN 212-2, Form B ($\varnothing \geq 3,76$ mm)

Dimensions								z	Order No.
d ₁	Tolerance	d ₂ h9	l ₁	l ₂	l ₃	l ₄	l ₅		
5,85	+0,005	5,6	93	26	36	57	53	6	30104354
5,86	+0,005	5,6	93	26	36	57	53	6	30104356
5,87	+0,005	5,6	93	26	36	57	53	6	30104358
5,88	+0,005	5,6	93	26	36	57	53	6	30104360
5,89	+0,005	5,6	93	26	36	57	53	6	30104362
5,90	+0,005	5,6	93	26	36	57	53	6	30104364
5,91	+0,005	5,6	93	26	36	57	53	6	30104366
5,92	+0,005	5,6	93	26	36	57	53	6	30104368
5,93	+0,005	5,6	93	26	36	57	53	6	30104370
5,94	+0,005	5,6	93	26	36	57	53	6	30104372
5,95	+0,005	5,6	93	26	36	57	53	6	30104374
5,96	+0,005	5,6	93	26	36	57	53	6	30104376
5,97	+0,005	5,6	93	26	36	57	53	6	30104378
5,98	+0,005	5,6	93	26	36	57	53	6	30104380
5,99	+0,005	5,6	93	26	36	57	53	6	30104382
6,00	+0,005	5,6	93	26	36	57	53	6	30104384
6,01	+0,005	5,6	93	26	36	57	53	6	30104386
6,02	+0,005	5,6	93	26	36	57	53	6	30104388
6,03	+0,005	5,6	93	26	36	57	53	6	30104390
6,04	+0,005	6,3	101	28	36	65	61	6	30104392
6,05	+0,005	6,3	101	28	36	65	61	6	30104394
6,06	+0,005	6,3	101	28	36	65	61	6	30104396
6,07	+0,005	6,3	101	28	36	65	61	6	30104398
6,08	+0,005	6,3	101	28	36	65	61	6	30104400
6,09	+0,005	6,3	101	28	36	65	61	6	30104402
6,10	+0,005	6,3	101	28	36	65	61	6	30104404
6,11	+0,005	6,3	101	28	36	65	61	6	30104406
6,12	+0,005	6,3	101	28	36	65	61	6	30104408
6,13	+0,005	6,3	101	28	36	65	61	6	30104410
6,14	+0,005	6,3	101	28	36	65	61	6	30104412
6,15	+0,005	6,3	101	28	36	65	61	6	30104414
6,16	+0,005	6,3	101	28	36	65	61	6	30104416
6,17	+0,005	6,3	101	28	36	65	61	6	30104418
6,18	+0,005	6,3	101	28	36	65	61	6	30104420
6,19	+0,005	6,3	101	28	36	65	61	6	30104422
6,20	+0,005	6,3	101	28	36	65	61	6	30104424
6,21	+0,005	6,3	101	28	36	65	61	6	30104426
6,22	+0,005	6,3	101	28	36	65	61	6	30104428
6,23	+0,005	6,3	101	28	36	65	61	6	30104430
6,24	+0,005	6,3	101	28	36	65	61	6	30104432
6,25	+0,005	6,3	101	28	36	65	61	6	30104434
6,26	+0,005	6,3	101	28	36	65	61	6	30104436
6,27	+0,005	6,3	101	28	36	65	61	6	30104438
6,28	+0,005	6,3	101	28	36	65	61	6	30104440
6,29	+0,005	6,3	101	28	36	65	61	6	30104442
6,30	+0,005	6,3	101	28	36	65	61	6	30104444
6,31	+0,005	6,3	101	28	36	65	61	6	30104446
6,32	+0,005	6,3	101	28	36	65	61	6	30104448
6,33	+0,005	6,3	101	28	36	65	61	6	30104450
6,34	+0,005	6,3	101	28	36	65	61	6	30104452
6,35	+0,005	6,3	101	28	36	65	61	6	30104454
6,36	+0,005	6,3	101	28	36	65	61	6	30104456
6,37	+0,005	6,3	101	28	36	65	61	6	30104458
6,38	+0,005	6,3	101	28	36	65	61	6	30104460
6,39	+0,005	6,3	101	28	36	65	61	6	30104462
6,40	+0,005	6,3	101	28	36	65	61	6	30104464
6,41	+0,005	6,3	101	28	36	65	61	6	30104466

Machine reamer I 030513, preferred series in accordance to DIN 212-1, Form B ($\varnothing \leq 3,75$ mm) or DIN 212-2, Form B ($\varnothing \geq 3,76$ mm)

Dimensions								z	Order No.
d ₁	Tolerance	d ₂ h9	l ₁	l ₂	l ₃	l ₄	l ₅		
6,42	+0,005	6,3	101	28	36	65	61	6	30104468
6,43	+0,005	6,3	101	28	36	65	61	6	30104470
6,44	+0,005	6,3	101	28	36	65	61	6	30104472
6,45	+0,005	6,3	101	28	36	65	61	6	30104474
6,46	+0,005	6,3	101	28	36	65	61	6	30104476
6,47	+0,005	6,3	101	28	36	65	61	6	30104478
6,48	+0,005	6,3	101	28	36	65	61	6	30104480
6,49	+0,005	6,3	101	28	36	65	61	6	30104482
6,50	+0,005	6,3	101	28	36	65	61	6	30104484
6,51	+0,005	6,3	101	28	36	65	61	6	30104486
6,52	+0,005	6,3	101	28	36	65	61	6	30104488
6,53	+0,005	6,3	101	28	36	65	61	6	30104490
6,54	+0,005	6,3	101	28	36	65	61	6	30104492
6,55	+0,005	6,3	101	28	36	65	61	6	30104494
6,56	+0,005	6,3	101	28	36	65	61	6	30104496
6,57	+0,005	6,3	101	28	36	65	61	6	30104498
6,58	+0,005	6,3	101	28	36	65	61	6	30104500
6,59	+0,005	6,3	101	28	36	65	61	6	30104502
6,60	+0,005	6,3	101	28	36	65	61	6	30104504
6,61	+0,005	6,3	101	28	36	65	61	6	30104506
6,62	+0,005	6,3	101	28	36	65	61	6	30104508
6,63	+0,005	6,3	101	28	36	65	61	6	30104510
6,64	+0,005	6,3	101	28	36	65	61	6	30104512
6,65	+0,005	6,3	101	28	36	65	61	6	30104514
6,66	+0,005	6,3	101	28	36	65	61	6	30104516
6,67	+0,005	6,3	101	28	36	65	61	6	30104518
6,68	+0,005	6,3	101	28	36	65	61	6	30104520
6,69	+0,005	6,3	101	28	36	65	61	6	30104522
6,70	+0,005	6,3	101	28	36	65	61	6	30104524
6,71	+0,005	7,1	109	31	36	73	69	6	30104526
6,72	+0,005	7,1	109	31	36	73	69	6	30104528
6,73	+0,005	7,1	109	31	36	73	69	6	30104530
6,74	+0,005	7,1	109	31	36	73	69	6	30104532
6,75	+0,005	7,1	109	31	36	73	69	6	30104534
6,76	+0,005	7,1	109	31	36	73	69	6	30104536
6,77	+0,005	7,1	109	31	36	73	69	6	30104538
6,78	+0,005	7,1	109	31	36	73	69	6	30104540
6,79	+0,005	7,1	109	31	36	73	69	6	30104542
6,80	+0,005	7,1	109	31	36	73	69	6	30104544
6,81	+0,005	7,1	109	31	36	73	69	6	30104546
6,82	+0,005	7,1	109	31	36	73	69	6	30104548
6,83	+0,005	7,1	109	31	36	73	69	6	30104550
6,84	+0,005	7,1	109	31	36	73	69	6	30104552
6,85	+0,005	7,1	109	31	36	73	69	6	30104554
6,86	+0,005	7,1	109	31	36	73	69	6	30104556
6,87	+0,005	7,1	109	31	36	73	69	6	30104558
6,88	+0,005	7,1	109	31	36	73	69	6	30104560
6,89	+0,005	7,1	109	31	36	73	69	6	30104562
6,90	+0,005	7,1	109	31	36	73	69	6	30104564
6,91	+0,005	7,1	109	31	36	73	69	6	30104566
6,92	+0,005	7,1	109	31	36	73	69	6	30104568
6,93	+0,005	7,1	109	31	36	73	69	6	30104570
6,94	+0,005	7,1	109	31	36	73	69	6	30104572
6,95	+0,005	7,1	109	31	36	73	69	6	30104574
6,96	+0,005	7,1	109	31	36	73	69	6	30104576
6,97	+0,005	7,1	109	31	36	73	69	6	30104578

Continued on next page.

Machine reamer I 030513, preferred series in accordance to DIN 212-1, Form B ($\varnothing \leq 3,75$ mm) or DIN 212-2, Form B ($\varnothing \geq 3,76$ mm)

Dimensions								z	Order No.
d ₁	Tolerance	d ₂ h9	l ₁	l ₂	l ₃	l ₄	l ₅		
6,98	+0,005	7,1	109	31	36	73	69	6	30104580
6,99	+0,005	7,1	109	31	36	73	69	6	30104582
7,00	+0,005	7,1	109	31	36	73	69	6	30104584
7,01	+0,005	7,1	109	31	36	73	69	6	30104586
7,02	+0,005	7,1	109	31	36	73	69	6	30104588
7,03	+0,005	7,1	109	31	36	73	69	6	30104590
7,04	+0,005	7,1	109	31	36	73	69	6	30104592
7,05	+0,005	7,1	109	31	36	73	69	6	30104594
7,06	+0,005	7,1	109	31	36	73	69	6	30104596
7,07	+0,005	7,1	109	31	36	73	69	6	30104598
7,08	+0,005	7,1	109	31	36	73	69	6	30104600
7,09	+0,005	7,1	109	31	36	73	69	6	30104602
7,10	+0,005	7,1	109	31	36	73	69	6	30104604
7,11	+0,005	7,1	109	31	36	73	69	6	30104606
7,12	+0,005	7,1	109	31	36	73	69	6	30104608
7,13	+0,005	7,1	109	31	36	73	69	6	30104610
7,14	+0,005	7,1	109	31	36	73	69	6	30104612
7,15	+0,005	7,1	109	31	36	73	69	6	30104614
7,16	+0,005	7,1	109	31	36	73	69	6	30104616
7,17	+0,005	7,1	109	31	36	73	69	6	30104618
7,18	+0,005	7,1	109	31	36	73	69	6	30104620
7,19	+0,005	7,1	109	31	36	73	69	6	30104622
7,20	+0,005	7,1	109	31	36	73	69	6	30104624
7,21	+0,005	7,1	109	31	36	73	69	6	30104626
7,22	+0,005	7,1	109	31	36	73	69	6	30104628
7,23	+0,005	7,1	109	31	36	73	69	6	30104630
7,24	+0,005	7,1	109	31	36	73	69	6	30104632
7,25	+0,005	7,1	109	31	36	73	69	6	30104634
7,26	+0,005	7,1	109	31	36	73	69	6	30104636
7,27	+0,005	7,1	109	31	36	73	69	6	30104638
7,28	+0,005	7,1	109	31	36	73	69	6	30104640
7,29	+0,005	7,1	109	31	36	73	69	6	30104642
7,30	+0,005	7,1	109	31	36	73	69	6	30104644
7,31	+0,005	7,1	109	31	36	73	69	6	30104646
7,32	+0,005	7,1	109	31	36	73	69	6	30104648
7,33	+0,005	7,1	109	31	36	73	69	6	30104650
7,34	+0,005	7,1	109	31	36	73	69	6	30104652
7,35	+0,005	7,1	109	31	36	73	69	6	30104654
7,36	+0,005	7,1	109	31	36	73	69	6	30104656
7,37	+0,005	7,1	109	31	36	73	69	6	30104658
7,38	+0,005	7,1	109	31	36	73	69	6	30104660
7,39	+0,005	7,1	109	31	36	73	69	6	30104662
7,40	+0,005	7,1	109	31	36	73	69	6	30104664
7,41	+0,005	7,1	109	31	36	73	69	6	30104666
7,42	+0,005	7,1	109	31	36	73	69	6	30104668
7,43	+0,005	7,1	109	31	36	73	69	6	30104670
7,44	+0,005	7,1	109	31	36	73	69	6	30104672
7,45	+0,005	7,1	109	31	36	73	69	6	30104674
7,46	+0,005	7,1	109	31	36	73	69	6	30104676
7,47	+0,005	7,1	109	31	36	73	69	6	30104678
7,48	+0,005	7,1	109	31	36	73	69	6	30104680
7,49	+0,005	7,1	109	31	36	73	69	6	30104682
7,50	+0,005	7,1	109	31	36	73	69	6	30104684
7,51	+0,005	8	117	33	36	81	77	6	30104686
7,52	+0,005	8	117	33	36	81	77	6	30104688
7,53	+0,005	8	117	33	36	81	77	6	30104690
7,54	+0,005	8	117	33	36	81	77	6	30104692

Machine reamer I 030513, preferred series in accordance to DIN 212-1, Form B ($\varnothing \leq 3,75$ mm) or DIN 212-2, Form B ($\varnothing \geq 3,76$ mm)

Dimensions								z	Order No.
d ₁	Tolerance	d ₂ h9	l ₁	l ₂	l ₃	l ₄	l ₅		
7,55	+0,005	8	117	33	36	81	77	6	30104694
7,56	+0,005	8	117	33	36	81	77	6	30104696
7,57	+0,005	8	117	33	36	81	77	6	30104698
7,58	+0,005	8	117	33	36	81	77	6	30104700
7,59	+0,005	8	117	33	36	81	77	6	30104702
7,60	+0,005	8	117	33	36	81	77	6	30104704
7,61	+0,005	8	117	33	36	81	77	6	30104706
7,62	+0,005	8	117	33	36	81	77	6	30104708
7,63	+0,005	8	117	33	36	81	77	6	30104710
7,64	+0,005	8	117	33	36	81	77	6	30104712
7,65	+0,005	8	117	33	36	81	77	6	30104714
7,66	+0,005	8	117	33	36	81	77	6	30104716
7,67	+0,005	8	117	33	36	81	77	6	30104718
7,68	+0,005	8	117	33	36	81	77	6	30104720
7,69	+0,005	8	117	33	36	81	77	6	30104722
7,70	+0,005	8	117	33	36	81	77	6	30104724
7,71	+0,005	8	117	33	36	81	77	6	30104726
7,72	+0,005	8	117	33	36	81	77	6	30104728
7,73	+0,005	8	117	33	36	81	77	6	30104730
7,74	+0,005	8	117	33	36	81	77	6	30104732
7,75	+0,005	8	117	33	36	81	77	6	30104734
7,76	+0,005	8	117	33	36	81	77	6	30104736
7,77	+0,005	8	117	33	36	81	77	6	30104738
7,78	+0,005	8	117	33	36	81	77	6	30104740
7,79	+0,005	8	117	33	36	81	77	6	30104742
7,80	+0,005	8	117	33	36	81	77	6	30104744
7,81	+0,005	8	117	33	36	81	77	6	30104746
7,82	+0,005	8	117	33	36	81	77	6	30104748
7,83	+0,005	8	117	33	36	81	77	6	30104750
7,84	+0,005	8	117	33	36	81	77	6	30104752
7,85	+0,005	8	117	33	36	81	77	6	30104754
7,86	+0,005	8	117	33	36	81	77	6	30104756
7,87	+0,005	8	117	33	36	81	77	6	30104758
7,88	+0,005	8	117	33	36	81	77	6	30104760
7,89	+0,005	8	117	33	36	81	77	6	30104762
7,90	+0,005	8	117	33	36	81	77	6	30104764
7,91	+0,005	8	117	33	36	81	77	6	30104766
7,92	+0,005	8	117	33	36	81	77	6	30104768
7,93	+0,005	8	117	33	36	81	77	6	30104770
7,94	+0,005	8	117	33	36	81	77	6	30104772
7,95	+0,005	8	117	33	36	81	77	6	30104774
7,96	+0,005	8	117	33	36	81	77	6	30104776
7,97	+0,005	8	117	33	36	81	77	6	30104778
7,98	+0,005	8	117	33	36	81	77	6	30104780
7,99	+0,005	8	117	33	36	81	77	6	30104782
8,00	+0,005	8	117	33	36	81	77	6	30104784
8,01	+0,005	8	117	33	36	81	77	6	30104786
8,02	+0,005	8	117	33	36	81	77	6	30104788
8,03	+0,005	8	117	33	36	81	77	6	30104790
8,04	+0,005	8	117	33	36	81	77	6	30104792
8,05	+0,005	8	117	33	36	81	77	6	30104794
8,06	+0,005	8	117	33	36	81	77	6	30104796
8,07	+0,005	8	117	33	36	81	77	6	30104798
8,08	+0,005	8	117	33	36	81	77	6	30104800
8,09	+0,005	8	117	33	36	81	77	6	30104802
8,10	+0,005	8	117	33	36	81	77	6	30104804

Continued on next page.

Machine reamer I 030513, preferred series in accordance to DIN 212-1, Form B ($\varnothing \leq 3,75$ mm) or DIN 212-2, Form B ($\varnothing \geq 3,76$ mm)

Dimensions								z	Order No.
d ₁	Tolerance	d ₂ h9	l ₁	l ₂	l ₃	l ₄	l ₅		
8,11	+0,005	8	117	33	36	81	77	6	30104806
8,12	+0,005	8	117	33	36	81	77	6	30104808
8,13	+0,005	8	117	33	36	81	77	6	30104810
8,14	+0,005	8	117	33	36	81	77	6	30104812
8,15	+0,005	8	117	33	36	81	77	6	30104814
8,16	+0,005	8	117	33	36	81	77	6	30104816
8,17	+0,005	8	117	33	36	81	77	6	30104818
8,18	+0,005	8	117	33	36	81	77	6	30104820
8,19	+0,005	8	117	33	36	81	77	6	30104822
8,20	+0,005	8	117	33	36	81	77	6	30104824
8,21	+0,005	8	117	33	36	81	77	6	30104826
8,22	+0,005	8	117	33	36	81	77	6	30104828
8,23	+0,005	8	117	33	36	81	77	6	30104830
8,24	+0,005	8	117	33	36	81	77	6	30104832
8,25	+0,005	8	117	33	36	81	77	6	30104834
8,26	+0,005	8	117	33	36	81	77	6	30104836
8,27	+0,005	8	117	33	36	81	77	6	30104838
8,28	+0,005	8	117	33	36	81	77	6	30104840
8,29	+0,005	8	117	33	36	81	77	6	30104842
8,30	+0,005	8	117	33	36	81	77	6	30104844
8,31	+0,005	8	117	33	36	81	77	6	30104846
8,32	+0,005	8	117	33	36	81	77	6	30104848
8,33	+0,005	8	117	33	36	81	77	6	30104850
8,34	+0,005	8	117	33	36	81	77	6	30104852
8,35	+0,005	8	117	33	36	81	77	6	30104854
8,36	+0,005	8	117	33	36	81	77	6	30104856
8,37	+0,005	8	117	33	36	81	77	6	30104858
8,38	+0,005	8	117	33	36	81	77	6	30104860
8,39	+0,005	8	117	33	36	81	77	6	30104862
8,40	+0,005	8	117	33	36	81	77	6	30104864
8,41	+0,005	8	117	33	36	81	77	6	30104866
8,42	+0,005	8	117	33	36	81	77	6	30104868
8,43	+0,005	8	117	33	36	81	77	6	30104870
8,44	+0,005	8	117	33	36	81	77	6	30104872
8,45	+0,005	8	117	33	36	81	77	6	30104874
8,46	+0,005	8	117	33	36	81	77	6	30104876
8,47	+0,005	8	117	33	36	81	77	6	30104878
8,48	+0,005	8	117	33	36	81	77	6	30104880
8,49	+0,005	8	117	33	36	81	77	6	30104882
8,50	+0,005	8	117	33	36	81	77	6	30104884
8,51	+0,005	9	125	36	40	85	81	6	30104886
8,52	+0,005	9	125	36	40	85	81	6	30104888
8,53	+0,005	9	125	36	40	85	81	6	30104890
8,54	+0,005	9	125	36	40	85	81	6	30104892
8,55	+0,005	9	125	36	40	85	81	6	30104894
8,56	+0,005	9	125	36	40	85	81	6	30104896
8,57	+0,005	9	125	36	40	85	81	6	30104898
8,58	+0,005	9	125	36	40	85	81	6	30104900
8,59	+0,005	9	125	36	40	85	81	6	30104902
8,60	+0,005	9	125	36	40	85	81	6	30104904
8,61	+0,005	9	125	36	40	85	81	6	30104906
8,62	+0,005	9	125	36	40	85	81	6	30104908
8,63	+0,005	9	125	36	40	85	81	6	30104910
8,64	+0,005	9	125	36	40	85	81	6	30104912
8,65	+0,005	9	125	36	40	85	81	6	30104914
8,66	+0,005	9	125	36	40	85	81	6	30104916
8,67	+0,005	9	125	36	40	85	81	6	30104918

Machine reamer I 030513, preferred series in accordance to DIN 212-1, Form B ($\varnothing \leq 3,75$ mm) or DIN 212-2, Form B ($\varnothing \geq 3,76$ mm)

Dimensions								z	Order No.
d ₁	Tolerance	d ₂ h9	l ₁	l ₂	l ₃	l ₄	l ₅		
8,68	+0,005	9	125	36	40	85	81	6	30104920
8,69	+0,005	9	125	36	40	85	81	6	30104922
8,70	+0,005	9	125	36	40	85	81	6	30104924
8,71	+0,005	9	125	36	40	85	81	6	30104926
8,72	+0,005	9	125	36	40	85	81	6	30104928
8,73	+0,005	9	125	36	40	85	81	6	30104930
8,74	+0,005	9	125	36	40	85	81	6	30104932
8,75	+0,005	9	125	36	40	85	81	6	30104934
8,76	+0,005	9	125	36	40	85	81	6	30104936
8,77	+0,005	9	125	36	40	85	81	6	30104938
8,78	+0,005	9	125	36	40	85	81	6	30104940
8,79	+0,005	9	125	36	40	85	81	6	30104942
8,80	+0,005	9	125	36	40	85	81	6	30104944
8,81	+0,005	9	125	36	40	85	81	6	30104946
8,82	+0,005	9	125	36	40	85	81	6	30104948
8,83	+0,005	9	125	36	40	85	81	6	30104950
8,84	+0,005	9	125	36	40	85	81	6	30104952
8,85	+0,005	9	125	36	40	85	81	6	30104954
8,86	+0,005	9	125	36	40	85	81	6	30104956
8,87	+0,005	9	125	36	40	85	81	6	30104958
8,88	+0,005	9	125	36	40	85	81	6	30104960
8,89	+0,005	9	125	36	40	85	81	6	30104962
8,90	+0,005	9	125	36	40	85	81	6	30104964
8,91	+0,005	9	125	36	40	85	81	6	30104966
8,92	+0,005	9	125	36	40	85	81	6	30104968
8,93	+0,005	9	125	36	40	85	81	6	30104970
8,94	+0,005	9	125	36	40	85	81	6	30104972
8,95	+0,005	9	125	36	40	85	81	6	30104974
8,96	+0,005	9	125	36	40	85	81	6	30104976
8,97	+0,005	9	125	36	40	85	81	6	30104978
8,98	+0,005	9	125	36	40	85	81	6	30104980
8,99	+0,005	9	125	36	40	85	81	6	30104982
9,00	+0,005	9	125	36	40	85	81	6	30104984
9,01	+0,005	9	125	36	40	85	81	6	30104986
9,02	+0,005	9	125	36	40	85	81	6	30104988
9,03	+0,005	9	125	36	40	85	81	6	30104990
9,04	+0,005	9	125	36	40	85	81	6	30104992
9,05	+0,005	9	125	36	40	85	81	6	30104994
9,06	+0,005	9	125	36	40	85	81	6	30104996
9,07	+0,005	9	125	36	40	85	81	6	30104998
9,08	+0,005	9	125	36	40	85	81	6	30105000
9,09	+0,005	9	125	36	40	85	81	6	30105002
9,10	+0,005	9	125	36	40	85	81	6	30105004
9,11	+0,005	9	125	36	40	85	81	6	30105006
9,12	+0,005	9	125	36	40	85	81	6	30105008
9,13	+0,005	9	125	36	40	85	81	6	30105010
9,14	+0,005	9	125	36	40	85	81	6	30105012
9,15	+0,005	9	125	36	40	85	81	6	30105014
9,16	+0,005	9	125	36	40	85	81	6	30105016
9,17	+0,005	9	125	36	40	85	81	6	30105018
9,18	+0,005	9	125	36	40	85	81	6	30105020
9,19	+0,005	9	125	36	40	85	81	6	30105022
9,20	+0,005	9	125	36	40	85	81	6	30105024
9,21	+0,005	9	125	36	40	85	81	6	30105026
9,22	+0,005	9	125	36	40	85	81	6	30105028
9,23	+0,005	9	125	36	40	85	81	6	30105030

Continued on next page.

Machine reamer I 030513, preferred series in accordance to DIN 212-1, Form B ($\varnothing \leq 3,75$ mm) or DIN 212-2, Form B ($\varnothing \geq 3,76$ mm)

Dimensions								z	Order No.
d ₁	Tolerance	d ₂ h9	l ₁	l ₂	l ₃	l ₄	l ₅		
9,24	+0,005	9	125	36	40	85	81	6	30105032
9,25	+0,005	9	125	36	40	85	81	6	30105034
9,26	+0,005	9	125	36	40	85	81	6	30105036
9,27	+0,005	9	125	36	40	85	81	6	30105038
9,28	+0,005	9	125	36	40	85	81	6	30105040
9,29	+0,005	9	125	36	40	85	81	6	30105042
9,30	+0,005	9	125	36	40	85	81	6	30105044
9,31	+0,005	9	125	36	40	85	81	6	30105046
9,32	+0,005	9	125	36	40	85	81	6	30105048
9,33	+0,005	9	125	36	40	85	81	6	30105050
9,34	+0,005	9	125	36	40	85	81	6	30105052
9,35	+0,005	9	125	36	40	85	81	6	30105054
9,36	+0,005	9	125	36	40	85	81	6	30105056
9,37	+0,005	9	125	36	40	85	81	6	30105058
9,38	+0,005	9	125	36	40	85	81	6	30105060
9,39	+0,005	9	125	36	40	85	81	6	30105062
9,40	+0,005	9	125	36	40	85	81	6	30105064
9,41	+0,005	9	125	36	40	85	81	6	30105066
9,42	+0,005	9	125	36	40	85	81	6	30105068
9,43	+0,005	9	125	36	40	85	81	6	30105070
9,44	+0,005	9	125	36	40	85	81	6	30105072
9,45	+0,005	9	125	36	40	85	81	6	30105074
9,46	+0,005	9	125	36	40	85	81	6	30105076
9,47	+0,005	9	125	36	40	85	81	6	30105078
9,48	+0,005	9	125	36	40	85	81	6	30105090
9,49	+0,005	9	125	36	40	85	81	6	30105092
9,50	+0,005	9	125	36	40	85	81	6	30105094
9,51	+0,005	10	133	38	40	93	89	6	30105096
9,52	+0,005	10	133	38	40	93	89	6	30105098
9,53	+0,005	10	133	38	40	93	89	6	30105100
9,54	+0,005	10	133	38	40	93	89	6	30105102
9,55	+0,005	10	133	38	40	93	89	6	30105104
9,56	+0,005	10	133	38	40	93	89	6	30105106
9,57	+0,005	10	133	38	40	93	89	6	30105108
9,58	+0,005	10	133	38	40	93	89	6	30105110
9,59	+0,005	10	133	38	40	93	89	6	30105112
9,60	+0,005	10	133	38	40	93	89	6	30105114
9,61	+0,005	10	133	38	40	93	89	6	30105116
9,62	+0,005	10	133	38	40	93	89	6	30105118
9,63	+0,005	10	133	38	40	93	89	6	30105120
9,64	+0,005	10	133	38	40	93	89	6	30105122
9,65	+0,005	10	133	38	40	93	89	6	30105124
9,66	+0,005	10	133	38	40	93	89	6	30105126
9,67	+0,005	10	133	38	40	93	89	6	30105128
9,68	+0,005	10	133	38	40	93	89	6	30105130
9,69	+0,005	10	133	38	40	93	89	6	30105132
9,70	+0,005	10	133	38	40	93	89	6	30105134
9,71	+0,005	10	133	38	40	93	89	6	30105136
9,72	+0,005	10	133	38	40	93	89	6	30105138
9,73	+0,005	10	133	38	40	93	89	6	30105140
9,74	+0,005	10	133	38	40	93	89	6	30105142
9,75	+0,005	10	133	38	40	93	89	6	30105144
9,76	+0,005	10	133	38	40	93	89	6	30105146
9,77	+0,005	10	133	38	40	93	89	6	30105148
9,78	+0,005	10	133	38	40	93	89	6	30105150
9,79	+0,005	10	133	38	40	93	89	6	30105152
9,80	+0,005	10	133	38	40	93	89	6	30105154

Machine reamer I 030513, preferred series in accordance to DIN 212-1, Form B ($\varnothing \leq 3,75$ mm) or DIN 212-2, Form B ($\varnothing \geq 3,76$ mm)

Dimensions								z	Order No.
d ₁	Tolerance	d ₂ h9	l ₁	l ₂	l ₃	l ₄	l ₅		
9,81	+0,005	10	133	38	40	93	89	6	30105156
9,82	+0,005	10	133	38	40	93	89	6	30105158
9,83	+0,005	10	133	38	40	93	89	6	30105160
9,84	+0,005	10	133	38	40	93	89	6	30105162
9,85	+0,005	10	133	38	40	93	89	6	30105164
9,86	+0,005	10	133	38	40	93	89	6	30105166
9,87	+0,005	10	133	38	40	93	89	6	30105168
9,88	+0,005	10	133	38	40	93	89	6	30105170
9,89	+0,005	10	133	38	40	93	89	6	30105172
9,90	+0,005	10	133	38	40	93	89	6	30105174
9,91	+0,005	10	133	38	40	93	89	6	30105176
9,92	+0,005	10	133	38	40	93	89	6	30105178
9,93	+0,005	10	133	38	40	93	89	6	30105180
9,94	+0,005	10	133	38	40	93	89	6	30105182
9,95	+0,005	10	133	38	40	93	89	6	30105184
9,96	+0,005	10	133	38	40	93	89	6	30105186
9,97	+0,005	10	133	38	40	93	89	6	30105188
9,98	+0,005	10	133	38	40	93	89	6	30105190
9,99	+0,005	10	133	38	40	93	89	6	30105192
10,00	+0,005	10	133	38	40	93	89	6	30105194
10,01	+0,005	10	133	38	40	93	89	6	30105196
10,02	+0,005	10	133	38	40	93	89	6	30105198
10,03	+0,005	10	133	38	40	93	89	6	30105200
10,04	+0,005	10	133	38	40	93	89	6	30105202
10,05	+0,005	10	133	38	40	93	89	6	30105204
10,06	+0,005	10	133	38	40	93	89	6	30105206
10,07	+0,005	10	133	38	40	93	89	6	30105208
10,08	+0,005	10	133	38	40	93	89	6	30105210
10,09	+0,005	10	133	38	40	93	89	6	30105212
10,10	+0,005	10	133	38	40	93	89	6	30105214
10,11	+0,005	10	133	38	40	93	89	6	30105216
10,12	+0,005	10	133	38	40	93	89	6	30105218
10,13	+0,005	10	133	38	40	93	89	6	30105220
10,14	+0,005	10	133	38	40	93	89	6	30105222
10,15	+0,005	10	133	38	40	93	89	6	30105224
10,16	+0,005	10	133	38	40	93	89	6	30105226
10,17	+0,005	10	133	38	40	93	89	6	30105228
10,18	+0,005	10	133	38	40	93	89	6	30105230
10,19	+0,005	10	133	38	40	93	89	6	30105232
10,20	+0,005	10	133	38	40	93	89	6	30105234
10,21	+0,005	10	133	38	40	93	89	6	30105236
10,22	+0,005	10	133	38	40	93	89	6	30105238
10,23	+0,005	10	133	38	40	93	89	6	30105240
10,24	+0,005	10	133	38	40	93	89	6	30105242
10,25	+0,005	10	133	38	40	93	89	6	30105244
10,26	+0,005	10	133	38	40	93	89	6	30105246
10,27	+0,005	10	133	38	40	93	89	6	30105248
10,28	+0,005	10	133	38	40	93	89	6	30105250
10,29	+0,005	10	133	38	40	93	89	6	30105252
10,30	+0,005	10	133	38	40	93	89	6	30105254
10,31	+0,005	10	133	38	40	93	89	6	30105256
10,32	+0,005	10	133	38	40	93	89	6	30105258
10,33	+0,005	10	133	38	40	93	89	6	30105260
10,34	+0,005	10	133	38	40	93	89	6	30105262
10,35	+0,005	10	133	38	40	93	89	6	30105264
10,36	+0,005	10	133	38	40	93	89	6	30105266

Continued on next page.

Machine reamer I 030513, preferred series in accordance to DIN 212-1, Form B ($\varnothing \leq 3,75$ mm) or DIN 212-2, Form B ($\varnothing \geq 3,76$ mm)

Dimensions								z	Order No.
d ₁	Tolerance	d ₂ h9	l ₁	l ₂	l ₃	l ₄	l ₅		
10,37	+0,005	10	133	38	40	93	89	6	30105268
10,38	+0,005	10	133	38	40	93	89	6	30105270
10,39	+0,005	10	133	38	40	93	89	6	30105272
10,40	+0,005	10	133	38	40	93	89	6	30105274
10,41	+0,005	10	133	38	40	93	89	6	30105276
10,42	+0,005	10	133	38	40	93	89	6	30105278
10,43	+0,005	10	133	38	40	93	89	6	30105280
10,44	+0,005	10	133	38	40	93	89	6	30105282
10,45	+0,005	10	133	38	40	93	89	6	30105284
10,46	+0,005	10	133	38	40	93	89	6	30105286
10,47	+0,005	10	133	38	40	93	89	6	30105288
10,48	+0,005	10	133	38	40	93	89	6	30105290
10,49	+0,005	10	133	38	40	93	89	6	30105292
10,50	+0,005	10	133	38	40	93	89	6	30105294
10,51	+0,005	10	133	38	40	93	89	6	30105296
10,52	+0,005	10	133	38	40	93	89	6	30105298
10,53	+0,005	10	133	38	40	93	89	6	30105300
10,54	+0,005	10	133	38	40	93	89	6	30105302
10,55	+0,005	10	133	38	40	93	89	6	30105304
10,56	+0,005	10	133	38	40	93	89	6	30105306
10,57	+0,005	10	133	38	40	93	89	6	30105308
10,58	+0,005	10	133	38	40	93	89	6	30105310
10,59	+0,005	10	133	38	40	93	89	6	30105312
10,60	+0,005	10	133	38	40	93	89	6	30105314
10,61	+0,005	10	142	41	40	102	98	6	30105316
10,62	+0,005	10	142	41	40	102	98	6	30105318
10,63	+0,005	10	142	41	40	102	98	6	30105320
10,64	+0,005	10	142	41	40	102	98	6	30105322
10,65	+0,005	10	142	41	40	102	98	6	30105324
10,66	+0,005	10	142	41	40	102	98	6	30105326
10,67	+0,005	10	142	41	40	102	98	6	30105328
10,68	+0,005	10	142	41	40	102	98	6	30105330
10,69	+0,005	10	142	41	40	102	98	6	30105332
10,70	+0,005	10	142	41	40	102	98	6	30105334
10,71	+0,005	10	142	41	40	102	98	6	30105336
10,72	+0,005	10	142	41	40	102	98	6	30105338
10,73	+0,005	10	142	41	40	102	98	6	30105340
10,74	+0,005	10	142	41	40	102	98	6	30105342
10,75	+0,005	10	142	41	40	102	98	6	30105344
10,76	+0,005	10	142	41	40	102	98	6	30105346
10,77	+0,005	10	142	41	40	102	98	6	30105348
10,78	+0,005	10	142	41	40	102	98	6	30105350
10,79	+0,005	10	142	41	40	102	98	6	30105352
10,80	+0,005	10	142	41	40	102	98	6	30105354
10,81	+0,005	10	142	41	40	102	98	6	30105356
10,82	+0,005	10	142	41	40	102	98	6	30105358
10,83	+0,005	10	142	41	40	102	98	6	30105360
10,84	+0,005	10	142	41	40	102	98	6	30105362
10,85	+0,005	10	142	41	40	102	98	6	30105364
10,86	+0,005	10	142	41	40	102	98	6	30105366
10,87	+0,005	10	142	41	40	102	98	6	30105368
10,88	+0,005	10	142	41	40	102	98	6	30105370
10,89	+0,005	10	142	41	40	102	98	6	30105372
10,90	+0,005	10	142	41	40	102	98	6	30105374
10,91	+0,005	10	142	41	40	102	98	6	30105376
10,92	+0,005	10	142	41	40	102	98	6	30105378
10,93	+0,005	10	142	41	40	102	98	6	30105380

Machine reamer I 030513, preferred series in accordance to DIN 212-1, Form B ($\varnothing \leq 3,75$ mm) or DIN 212-2, Form B ($\varnothing \geq 3,76$ mm)

Dimensions								z	Order No.
d ₁	Tolerance	d ₂ h9	l ₁	l ₂	l ₃	l ₄	l ₅		
10,94	+0,005	10	142	41	40	102	98	6	30105382
10,95	+0,005	10	142	41	40	102	98	6	30105384
10,96	+0,005	10	142	41	40	102	98	6	30105386
10,97	+0,005	10	142	41	40	102	98	6	30105388
10,98	+0,005	10	142	41	40	102	98	6	30105390
10,99	+0,005	10	142	41	40	102	98	6	30105392
11,00	+0,005	10	142	41	40	102	98	6	30105394
11,01	+0,005	10	142	41	40	102	98	6	30105396
11,02	+0,005	10	142	41	40	102	98	6	30105398
11,03	+0,005	10	142	41	40	102	98	6	30105400
11,04	+0,005	10	142	41	40	102	98	6	30105402
11,05	+0,005	10	142	41	40	102	98	6	30105404
11,06	+0,005	10	142	41	40	102	98	6	30105406
11,07	+0,005	10	142	41	40	102	98	6	30105408
11,08	+0,005	10	142	41	40	102	98	6	30105410
11,09	+0,005	10	142	41	40	102	98	6	30105412
11,10	+0,005	10	142	41	40	102	98	6	30105414
11,11	+0,005	10	142	41	40	102	98	6	30105416
11,12	+0,005	10	142	41	40	102	98	6	30105418
11,13	+0,005	10	142	41	40	102	98	6	30105420
11,14	+0,005	10	142	41	40	102	98	6	30105422
11,15	+0,005	10	142	41	40	102	98	6	30105424
11,16	+0,005	10	142	41	40	102	98	6	30105426
11,17	+0,005	10	142	41	40	102	98	6	30105428
11,18	+0,005	10	142	41	40	102	98	6	30105430
11,19	+0,005	10	142	41	40	102	98	6	30105432
11,20	+0,005	10	142	41	40	102	98	6	30105434
11,21	+0,005	10	142	41	40	102	98	6	30105436
11,22	+0,005	10	142	41	40	102	98	6	30105438
11,23	+0,005	10	142	41	40	102	98	6	30105440
11,24	+0,005	10	142	41	40	102	98	6	30105442
11,25	+0,005	10	142	41	40	102	98	6	30105444
11,26	+0,005	10	142	41	40	102	98	6	30105446
11,27	+0,005	10	142	41	40	102	98	6	30105448
11,28	+0,005	10	142	41	40	102	98	6	30105450
11,29	+0,005	10	142	41	40	102	98	6	30105452
11,30	+0,005	10	142	41	40	102	98	6	30105454
11,31	+0,005	10	142	41	40	102	98	6	30105456
11,32	+0,005	10	142	41	40	102	98	6	30105458
11,33	+0,005	10	142	41	40	102	98	6	30105460
11,34	+0,005	10	142	41	40	102	98	6	30105462
11,35	+0,005	10	142	41	40	102	98	6	30105464
11,36	+0,005	10	142	41	40	102	98	6	30105466
11,37	+0,005	10	142	41	40	102	98	6	30105468
11,38	+0,005	10	142	41	40	102	98	6	30105470
11,39	+0,005	10	142	41	40	102	98	6	30105472
11,40	+0,005	10	142	41	40	102	98	6	30105474
11,41	+0,005	10	142	41	40	102	98	6	30105476
11,42	+0,005	10	142	41	40	102	98	6	30105478
11,43	+0,005	10	142	41	40	102	98	6	30105480
11,44	+0,005	10	142	41	40	102	98	6	30105482
11,45	+0,005	10	142	41	40	102	98	6	30105484
11,46	+0,005	10	142	41	40	102	98	6	30105486
11,47	+0,005	10	142	41	40	102	98	6	30105488
11,48	+0,005	10	142	41	40	102	98	6	30105490
11,49	+0,005	10	142	41	40	102	98	6	30105492

Continued on next page.

Machine reamer I 030513, preferred series in accordance to DIN 212-1, Form B ($\varnothing \leq 3,75$ mm) or DIN 212-2, Form B ($\varnothing \geq 3,76$ mm)

Dimensions								z	Order No.
d ₁	Tolerance	d ₂ h9	l ₁	l ₂	l ₃	l ₄	l ₅		
11,50	+0,005	10	142	41	40	102	98	6	30105494
11,51	+0,005	10	142	41	40	102	98	6	30105496
11,52	+0,005	10	142	41	40	102	98	6	30105498
11,53	+0,005	10	142	41	40	102	98	6	30105500
11,54	+0,005	10	142	41	40	102	98	6	30105502
11,55	+0,005	10	142	41	40	102	98	6	30105504
11,56	+0,005	10	142	41	40	102	98	6	30105506
11,57	+0,005	10	142	41	40	102	98	6	30105508
11,58	+0,005	10	142	41	40	102	98	6	30105510
11,59	+0,005	10	142	41	40	102	98	6	30105512
11,60	+0,005	10	142	41	40	102	98	6	30105514
11,61	+0,005	10	142	41	40	102	98	6	30105516
11,62	+0,005	10	142	41	40	102	98	6	30105518
11,63	+0,005	10	142	41	40	102	98	6	30105520
11,64	+0,005	10	142	41	40	102	98	6	30105522
11,65	+0,005	10	142	41	40	102	98	6	30105524
11,66	+0,005	10	142	41	40	102	98	6	30105526
11,67	+0,005	10	142	41	40	102	98	6	30105528
11,68	+0,005	10	142	41	40	102	98	6	30105530
11,69	+0,005	10	142	41	40	102	98	6	30105532
11,70	+0,005	10	142	41	40	102	98	6	30105534
11,71	+0,005	10	142	41	40	102	98	6	30105536
11,72	+0,005	10	142	41	40	102	98	6	30105538
11,73	+0,005	10	142	41	40	102	98	6	30105540
11,74	+0,005	10	142	41	40	102	98	6	30105542
11,75	+0,005	10	142	41	40	102	98	6	30105544
11,76	+0,005	10	142	41	40	102	98	6	30105546
11,77	+0,005	10	142	41	40	102	98	6	30105548
11,78	+0,005	10	142	41	40	102	98	6	30105550
11,79	+0,005	10	142	41	40	102	98	6	30105552
11,80	+0,005	10	142	41	40	102	98	6	30105554
11,81	+0,005	10	151	44	40	111	106	6	30105556
11,82	+0,005	10	151	44	40	111	106	6	30105558
11,83	+0,005	10	151	44	40	111	106	6	30105560
11,84	+0,005	10	151	44	40	111	106	6	30105562
11,85	+0,005	10	151	44	40	111	106	6	30105564
11,86	+0,005	10	151	44	40	111	106	6	30105566
11,87	+0,005	10	151	44	40	111	106	6	30105568
11,88	+0,005	10	151	44	40	111	106	6	30105570
11,89	+0,005	10	151	44	40	111	106	6	30105572
11,90	+0,005	10	151	44	40	111	106	6	30105574
11,91	+0,005	10	151	44	40	111	106	6	30105576
11,92	+0,005	10	151	44	40	111	106	6	30105578
11,93	+0,005	10	151	44	40	111	106	6	30105580
11,94	+0,005	10	151	44	40	111	106	6	30105582
11,95	+0,005	10	151	44	40	111	106	6	30105584
11,96	+0,005	10	151	44	40	111	106	6	30105586
11,97	+0,005	10	151	44	40	111	106	6	30105588
11,98	+0,005	10	151	44	40	111	106	6	30105590
11,99	+0,005	10	151	44	40	111	106	6	30105592
12,00	+0,005	10	151	44	40	111	106	6	30105594
12,01	+0,005	10	151	44	40	111	106	6	30105596
12,02	+0,005	10	151	44	40	111	106	6	30105598
12,03	+0,005	10	151	44	40	111	106	6	30105600
12,04	+0,005	10	151	44	40	111	106	6	30105602
12,05	+0,005	10	151	44	40	111	106	6	30105604

Machine reamer I 030110

Preferred series, with Morse taper shank

Design:

Diameter: 5,00-32,00 mm
 Cutting direction: Right-hand cutting
 Cutting material: HSS-E, uncoated
 Flute direction: Straight fluted

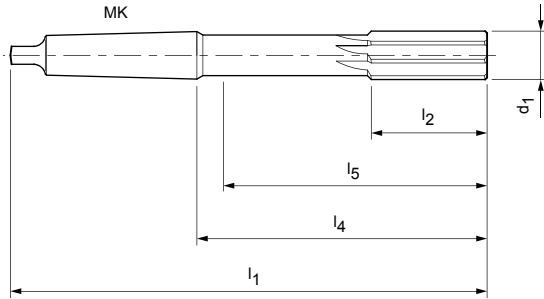

Dimensions						z	Order No.
d ₁ H7	MK	l ₁	l ₂	l ₄	l ₅		
5,00	1	133	23	67,5	58	6	30102665
6,00	1	138	26	72,5	64	6	30102667
7,00	1	150	31	84,5	76	6	30102669
8,00	1	156	33	90,5	83	6	30102671
9,00	1	162	36	96,5	90	6	30102673
10,00	1	168	38	102,5	96	6	30102675
11,00	1	175	41	109,5	105	6	30102677
12,00	1	182	44	116,5	112	6	30102679
13,00	1	182	44	116,5	112	6	30102681
14,00	1	189	47	123,5	119	8	30102683
15,00	2	204	50	124	117	8	30102685
16,00	2	210	52	130	124	8	30102687
17,00	2	214	54	134	129	8	30102689
18,00	2	219	56	139	134	8	30102691
19,00	2	223	58	143	138	8	30102693
20,00	2	228	60	148	143	8	30102695
21,00	2	232	62	152	147	8	30102697
22,00	2	237	64	157	152	8	30102699
23,00	2	241	66	161	156	8	30102701
24,00	3	268	68	169	164	8	30102703
25,00	3	268	68	169	164	8	30102705
26,00	3	273	70	174	169	8	30102707
27,00	3	277	71	178	173	10	30102709
28,00	3	277	71	178	173	10	30102711
29,00	3	281	73	182	177	10	30102713
30,00	3	281	73	182	177	10	30102715
31,00	3	285	75	186	181	10	30102717
32,00	4	317	77	193	188	10	30102719

Dimensions in mm.

Cutting data see page 367 ff.

Information on special designs and other coatings on request.

Machine reamer I 030110

Configurable series

Design:

Diameter: 4,751-33,500 mm
 Cutting direction: Right-hand cutting
 Cutting material: HSS-E, uncoated
 Flute direction: Spiral fluted

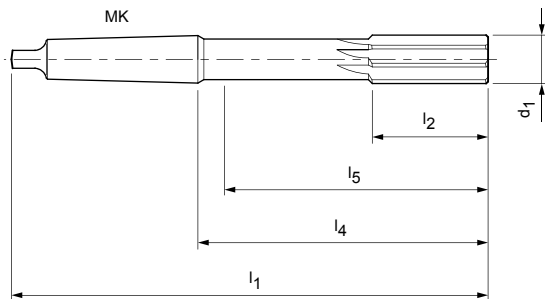

Dimensions						z
d ₁	MK	l ₁	l ₂	l ₄	l ₅	
4,751-5,300	1	133	23	67,5	58	6
5,301-6,050	1	138	26	72,5	64	6
6,051-6,700	1	144	28	78,5	70	6
6,701-7,500	1	150	31	84,5	76	6
7,501-8,500	1	156	33	90,5	83	6
8,501-9,500	1	162	36	96,5	90	6
9,501-10,600	1	168	38	102,5	96	6
10,601-11,800	1	175	41	109,5	105	6
11,801-12,200	1	182	44	116,5	112	6
12,201-13,200	1	182	44	116,5	112	6
13,201-14,100	1	189	47	123,5	119	8
14,101-15,100	2	204	50	124	117	8
15,101-16,100	2	210	52	130	124	8
16,101-17,100	2	214	54	134	129	8
17,101-18,100	2	219	56	139	134	8
18,101-19,100	2	223	58	143	138	8
19,101-20,100	2	228	60	148	143	8
20,101-21,200	2	232	62	152	147	8
21,201-22,400	2	237	64	157	152	8
22,401-23,600	2	241	66	161	156	8
23,601-25,100	3	268	68	169	164	8
25,101-26,500	3	273	70	174	169	8
26,501-28,100	3	277	71	178	173	10
28,101-30,100	3	281	73	182	177	10
30,101-31,500	3	285	75	186	181	10
31,501-33,500	4	317	77	193	188	10

Dimensions in mm.

Cutting data see page 367 ff.

Information on special designs and other coatings on request.

Machine reamer I 030111

Preferred series, with Morse taper shank

Design:

Diameter: 3,00-50,00 mm
 Cutting direction: Right-hand cutting
 Cutting material: HSS-E, uncoated
 Flute direction: Spiral fluted

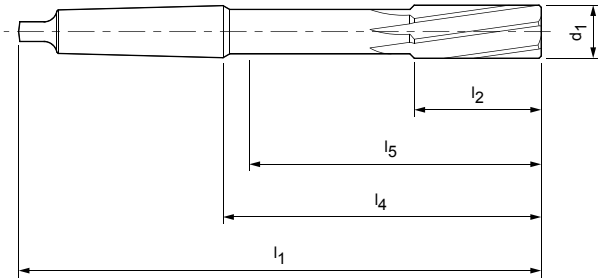

Dimensions						z	Order No.
d_1 H7	MK	l_1	l_2	l_4	l_5		
3,00	1	113	15	47,5	42	6	30102748
4,00	1	124	19	58,5	53	6	30102750
5,00	1	133	23	67,5	58	6	30102752
6,00	1	138	26	72,5	64	6	30102754
7,00	1	150	31	84,5	76	6	30102756
8,00	1	156	33	90,5	83	6	30102758
9,00	1	162	36	96,5	90	6	30102760
10,00	1	168	38	102,5	96	6	30102762
11,00	1	175	41	109,5	105	6	30102764
12,00	1	182	44	116,5	112	6	30102766
13,00	1	182	44	116,5	112	6	30102768
14,00	1	189	47	123,5	119	8	30102770
15,00	2	204	50	124	117	8	30102772
16,00	2	210	52	130	124	8	30102774
17,00	2	214	54	134	129	8	30102776
18,00	2	219	56	139	134	8	30102778
19,00	2	223	58	143	138	8	30102780
20,00	2	228	60	148	143	8	30102782
21,00	2	232	62	152	147	8	30102784
22,00	2	237	64	157	152	8	30102786
23,00	2	241	66	161	156	8	30102788
24,00	3	268	68	169	164	8	30102790
25,00	3	268	68	169	164	8	30102792
26,00	3	273	70	174	169	8	30102794
27,00	3	277	71	178	173	10	30102796
28,00	3	277	71	178	173	10	30102798
29,00	3	281	73	182	177	10	30102800
30,00	3	281	73	182	177	10	30102802
31,00	3	285	75	186	181	10	30102804
32,00	4	317	77	193	188	10	30102806
33,00	4	317	77	193	188	10	30102808
34,00	4	321	78	197	191	10	30102810
35,00	4	321	78	197	191	10	30102812
36,00	4	325	79	201	195	10	30102814
37,00	4	325	79	201	195	10	30102816
38,00	4	329	81	205	199	10	30102818
40,00	4	329	81	205	199	10	30102820
42,00	4	333	82	209	204	12	30102822

Machine reamer I 030111, preferred series in accordance to DIN 208, Form B

Dimensions						z	Order No.
d ₁ H7	MK	l ₁	l ₂	l ₄	l ₅		
44,00	4	336	83	212	206	12	30102824
45,00	4	336	83	212	206	12	30102826
46,00	4	340	84	216	210	12	30102828
47,00	4	340	84	216	210	12	30102830
48,00	4	344	86	220	214	12	30102832
50,00	4	344	86	220	214	12	30102834

Dimensions in mm.

Cutting data see page 367 ff.

Information on special designs and other coatings on request.

Machine reamer I 030111

Configurable series

Design:

Diameter: 2,810-50,100 mm
 Cutting direction: Right-hand cutting
 Cutting material: HSS-E, uncoated
 Flute direction: Spiral fluted

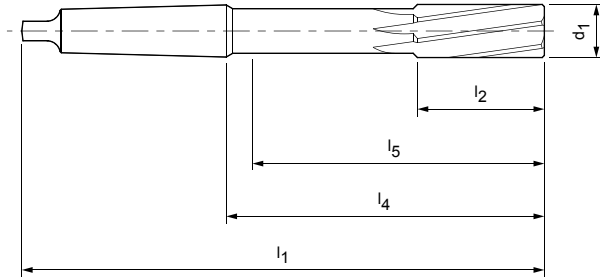

Dimensions						z
d ₁	MK	l ₁	l ₂	l ₄	l ₅	
2,810-3,000	1	113	15	47,5	42	6
3,001-3,350	1	117	16	51,5	46	6
3,351-3,750	1	120	18	54,5	49	6
3,751-4,250	1	124	19	58,5	53	6
4,251-4,750	1	128	21	62,5	57	6
4,751-5,300	1	133	23	67,5	58	6
5,301-6,050	1	138	26	72,5	64	6
6,051-6,700	1	144	28	78,5	70	6
6,701-7,500	1	150	31	84,5	76	6
7,501-8,500	1	156	33	90,5	83	6
8,501-9,500	1	162	36	96,5	90	6
9,501-10,600	1	168	38	102,5	96	6
10,601-11,800	1	175	41	109,5	105	6
11,801-12,200	1	182	44	116,5	112	6
12,201-13,200	1	182	44	116,5	112	6
13,201-14,100	1	189	47	123,5	119	8
14,101-15,100	2	204	50	124	117	8
15,101-16,100	2	210	52	130	124	8
16,101-17,100	2	214	54	134	129	8
17,101-18,100	2	219	56	139	134	8
18,101-19,100	2	223	58	143	138	8
19,101-20,100	2	228	60	148	143	8
20,101-21,200	2	232	62	152	147	8
21,201-22,400	2	237	64	157	152	8
22,401-23,600	2	241	66	161	156	8
23,601-25,100	3	268	68	169	164	8
25,101-26,500	3	273	70	174	169	8
26,501-28,100	3	277	71	178	173	10
28,101-30,100	3	281	73	182	177	10
30,101-31,500	3	285	75	186	181	10
31,501-33,500	4	317	77	193	188	10
33,501-35,500	4	321	78	197	191	10
35,501-37,500	4	325	79	201	195	10
37,501-40,100	4	329	81	205	199	10
40,101-42,500	4	333	82	209	204	12
42,501-45,100	4	336	83	212	206	12
45,101-47,500	4	340	84	216	210	12
47,501-50,100	4	344	86	220	214	12

Dimensions in mm.

Cutting data see page 367 ff.

Information on special designs and other coatings on request.

Machine reamer I 033111

Preferred series

Design:

Diameter: 10,00-20,00 mm
 Cutting direction: Right-hand cutting
 Cutting material: HSS-E, TiN coated
 Flute direction: Spiral fluted

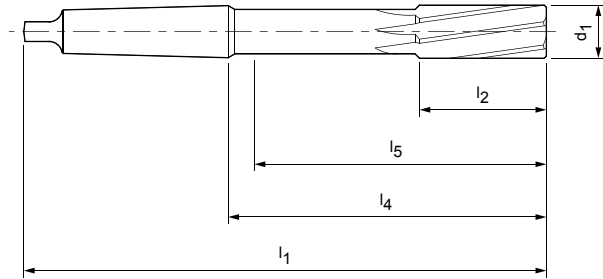

Dimensions						z	Order No.
d_1 H7	MK	l_1	l_2	l_4	l_5		
10,00	1	168	38	102,5	96	6	30107929
11,00	1	175	41	109,5	105	6	30107931
12,00	1	182	44	116,5	112	6	30107933
13,00	1	182	44	116,5	112	6	30107935
14,00	1	189	47	123,5	119	8	30107937
15,00	2	204	50	124	117	8	30107939
16,00	2	210	52	130	124	8	30107941
17,00	2	214	54	134	129	8	30107943
18,00	2	219	56	139	134	8	30107945
19,00	2	223	58	143	138	8	30107947
20,00	2	228	60	148	143	8	30107949

Dimensions in mm.

Cutting data see page 367 ff.

Information on special designs and other coatings on request.

Machine reamer I 033111

Configurable series

Design:

Diameter: 9,501-20,100 mm
 Cutting direction: Right-hand cutting
 Cutting material: HSS-E, TiN coated
 Flute direction: Spiral fluted

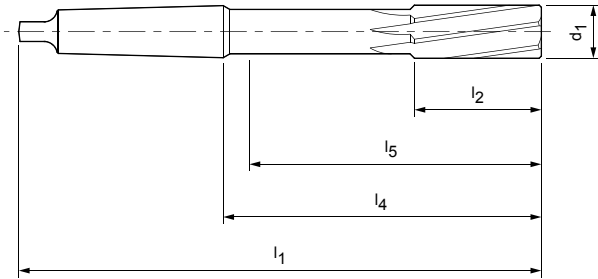

Dimensions						z
d_1	MK	l_1	l_2	l_4	l_5	
9,501-10,600	1	168	38	102,5	96	6
10,601-11,800	1	175	41	109,5	105	6
11,801-12,200	1	182	44	116,5	112	6
12,201-13,200	1	182	44	116,5	112	6
13,201-14,100	1	189	47	123,5	119	8
14,101-15,100	2	204	50	124	117	8
15,101-16,100	2	210	52	130	124	8
16,101-17,100	2	214	54	134	129	8
17,101-18,100	2	219	56	139	134	8
18,101-19,100	2	223	58	143	138	8
19,101-20,100	2	228	60	148	143	8

Dimensions in mm.

Cutting data see page 367 ff.

Information on special designs and other coatings on request.

Automatic lathe reamer I 030716

Preferred series, short design

Design:

Diameter: 4,00-20,00 mm
 Cutting direction: Right-hand cutting
 Cutting material: HSS-E, uncoated
 Flute direction: Spiral fluted

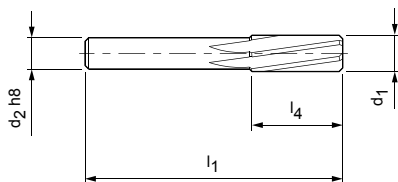

Dimensions					z	Order No.
d ₁ H7	d ₂ h8	l ₁	l ₂	l ₃		
4,00	3,55	56	20	28	6	30105762
4,50	4	63	22	28	6	30105764
5,00	4	63	22	28	6	30105766
5,50	5	63	22	28	6	30105768
6,00	5	63	22	28	6	30105770
6,50	5	63	22	28	6	30105772
7,00	6,3	71	25	36	6	30105774
7,50	6,3	71	25	36	6	30105776
8,00	6,3	71	25	36	6	30105778
8,50	6,3	71	25	36	6	30105780
9,00	8	71	25	36	6	30105782
9,50	8	71	25	36	6	30105784
10,00	8	71	25	36	6	30105786
10,50	8	71	25	36	6	30105788
11,00	10	80	28	40	6	30105790
11,50	10	80	28	40	6	30105792
12,00	10	80	28	40	6	30105794
13,00	10	80	32	45	6	30105796
14,00	12,5	90	32	45	8	30105798
15,00	12,5	90	32	45	8	30105800
16,00	12,5	90	32	45	8	30105802
17,00	12,5	90	32	45	8	30105804
18,00	16	100	36	48	8	30105806
19,00	16	100	36	48	8	30105808
20,00	16	100	36	48	8	30105810

Dimensions in mm.

Cutting data see page 367 ff.

Information on special designs and other coatings on request.

Automatic lathe reamer I 030716

Configurable series, short design

Design:

Diameter: 3,750-20,200 mm
 Cutting direction: Right-hand cutting
 Cutting material: HSS-E, uncoated
 Flute direction: Spiral fluted

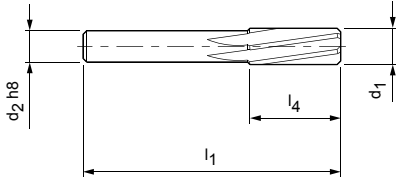

Dimensions					z
d_1	d_2 h8	l_1	l_2	l_3	
3,750-4,250	3,55	56	20	28	6
4,251-4,700	4	63	22	28	6
4,701-5,300	4	63	22	28	6
5,301-5,600	5	63	22	28	6
5,601-6,100	5	63	22	28	6
6,101-6,700	5	63	22	28	6
6,701-7,200	6,3	71	25	36	6
7,201-7,500	6,3	71	25	36	6
7,501-8,200	6,3	71	25	36	6
8,201-8,700	6,3	71	25	36	6
8,701-9,200	8	71	25	36	6
9,201-9,700	8	71	25	36	6
9,701-10,200	8	71	25	36	6
10,201-10,600	8	71	25	36	6
10,601-11,200	10	80	28	40	6
11,201-11,700	10	80	28	40	6
11,701-12,200	10	80	28	40	6
12,201-13,200	10	80	28	40	6
13,201-14,200	12,5	90	32	45	8
14,201-15,200	12,5	90	32	45	8
15,201-16,200	12,5	90	32	45	8
16,201-17,200	12,5	90	32	45	8
17,201-18,200	16	100	36	48	8
18,201-19,200	16	100	36	48	8
19,201-20,200	16	100	36	48	8

Dimensions in mm.
 Cutting data see page 367 ff.
 Information on special designs and other coatings on request.

Helical machine reamer I 030610

Preferred series

Design:

Diameter:

1,00-20,00 mm

Cutting direction:

Right-hand cutting

Cutting material:

HSS-E, uncoated

Flute direction:

Spiral fluted (approx. 45° left)

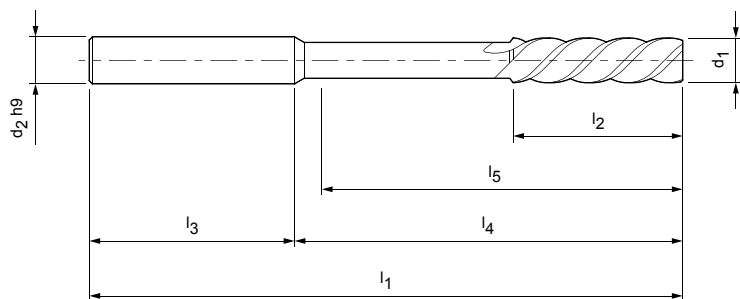

Dimensions							z	Order No.
d_1 H7	d_2 h9	l_1	l_2	l_3	l_4	l_5		
1,00	1	34	5,5	19	15	9,5	2	30105682
1,10	1,1	36	6,5	20,5	15,5	10	2	30310927
1,20	1,2	38	7,5	21,5	16,5	10,5	2	30105683
1,40	1,4	40	8	22	18	12	2	30105684
1,50	1,5	40	8	22	18	12	2	30105685
1,60	1,6	43	9	23	20	13,5	2	30105686
1,80	1,8	46	10	24	22	15	2	30105687
2,00	2	49	11	25	24	17	3	30105688
2,20	2,2	53	12	28	25	18	3	30105689
2,50	2,5	57	14	28	29	22	3	30105700
3,00	3	61	15	28	33	25	3	30105702
3,20	3,2	65	16	28	37	29	3	30105703
3,50	3,5	70	18	28	42	34	3	30105704
4,00	4	75	19	28	47	39	3	30105705
4,50	4,5	80	21	28	52	42	3	30105707
5,00	5	86	23	28	58	48	3	30105709
5,50	5,6	93	26	36	57	46	3	30105711
6,00	5,6	93	26	36	57	46	3	30105713
6,50	6,3	101	28	36	65	54	3	30105715
7,00	7,1	109	31	36	73	61	3	30105717
7,50	7,1	109	31	36	73	61	3	30105719
8,00	8	117	33	36	81	67	3	30105721
8,50	8	117	33	36	81	67	3	30105723
9,00	9	125	36	40	85	70	3	30105725
9,50	9	125	36	40	85	70	3	30105727
10,00	10	133	38	40	93	78	3	30105729
11,00	10	142	41	40	102	86	3	30105731
12,00	10	151	44	40	111	94	3	30105733
13,00	10	151	44	40	111	93	3	30105735
14,00	12,5	160	47	45	115	97	3	30105737
15,00	12,5	162	50	45	117	98	3	30105739
16,00	12,5	170	52	45	125	106	3	30105741
17,00	14	175	54	45	130	110	3	30105743
18,00	14	182	56	45	137	117	3	30105745
19,00	16	189	58	48	141	120	3	30105747
20,00	16	195	60	48	147	126	3	30105749

Dimensions in mm.

Cutting data see page 367 ff.

Information on special designs and other coatings on request.

Helical machine reamer | 030610

Configurable series

Design:

Diameter: 0,950-20,000 mm
 Cutting direction: Right-hand cutting
 Cutting material: HSS-E, uncoated
 Flute direction: Spiral fluted (approx. 45° left)

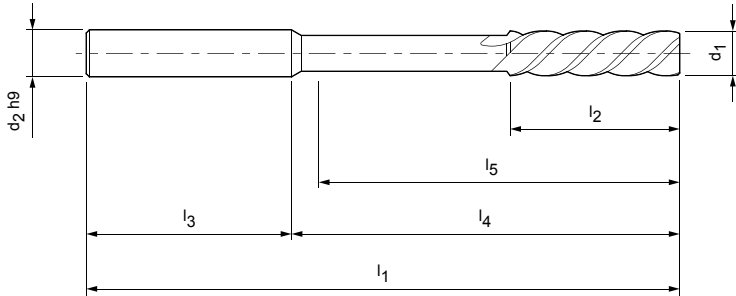

Dimensions							z
d_1	d_2 h9	l_1	l_2	l_3	l_4	l_5	
0,950-1,060	1	34	5,5	19	15	9,5	2
1,061-1,180	1,1	36	6,5	20,5	15,5	10	2
1,181-1,320	1,2	38	7,5	21,5	16,5	10,5	2
1,321-1,410	1,4	40	8	22	18	12	2
1,411-1,500	1,5	40	8	22	18	12	2
1,501-1,700	1,6	43	9	23	20	13,5	2
1,701-1,900	1,8	46	10	24	22	15	2
1,901-2,120	2	49	11	25	24	17	3
2,121-2,360	2,2	53	12	28	25	18	3
2,361-2,650	2,5	57	14	28	29	22	3
2,651-3,030	3	61	15	28	33	25	3
3,031-3,350	3,2	65	16	28	37	29	3
3,351-3,750	3,5	70	18	28	42	34	3
3,751-4,250	4	75	19	28	47	39	3
4,251-4,750	4,5	80	21	28	52	42	3
4,751-5,300	5	86	23	28	58	48	3
5,301-5,600	5,6	93	26	36	57	46	3
5,601-6,030	5,6	93	26	36	57	46	3
6,031-6,700	6,3	101	28	36	65	54	3
6,701-7,200	7,1	109	31	36	73	61	3
7,201-7,500	7,1	109	31	36	73	61	3
7,501-8,200	8	117	33	36	81	67	3
8,201-8,500	8	117	33	36	81	67	3
8,501-9,200	9	125	36	40	85	70	3
9,201-9,500	9	125	36	40	85	70	3
9,501-10,200	10	133	38	40	93	78	3
10,201-11,200	10	142	41	40	102	86	3
11,201-12,200	10	151	44	40	111	94	3
12,201-13,200	10	151	44	40	111	93	3
13,201-14,000	12,5	160	47	45	115	97	3
14,001-15,000	12,5	162	50	45	117	98	3
15,001-16,000	12,5	170	52	45	125	106	3
16,001-17,000	14	175	54	45	130	110	3
17,001-18,000	14	182	56	45	137	117	3
18,001-19,000	16	189	58	48	141	120	3
19,001-20,000	16	195	60	48	147	126	3

Dimensions in mm.

Cutting data see page 367 ff.

Information on special designs and other coatings on request.

Helical machine reamer I 030310

Preferred series with Morse taper shank

Design:

Diameter: 5,00-32,00 mm
 Cutting direction: Right-hand cutting
 Cutting material: HSS-E, uncoated
 Flute direction: Spiral fluted (approx. 45° left)

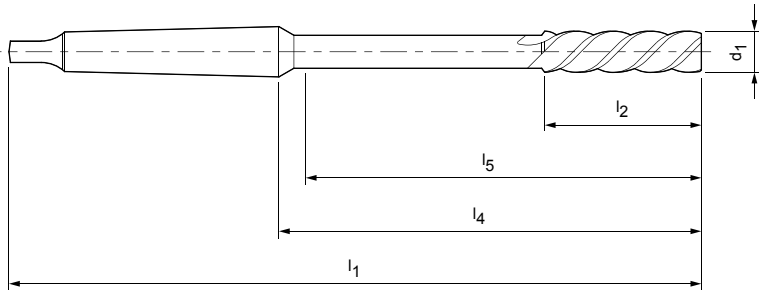

Dimensions						z	Order No.
d_1 H7	MK	l_1	l_2	l_4	l_5		
5,00	1	133	23	67,5	53	3	30102871
6,00	1	138	26	72,5	57	3	30102873
7,00	1	150	31	84,5	68	3	30102875
8,00	1	156	33	90,5	73	3	30102877
9,00	1	162	36	96,5	80	3	30102879
10,00	1	168	38	102,5	85	3	30102881
11,00	1	175	41	109,5	93	3	30102883
12,00	1	182	44	116,5	100	3	30102885
13,00	1	182	44	116,5	100	3	30102887
14,00	1	189	47	123,5	106	3	30102889
15,00	2	204	50	124	104	3	30102891
16,00	2	210	52	130	110	3	30102893
17,00	2	214	54	134	115	3	30102895
18,00	2	219	56	139	119	3	30102897
19,00	2	223	58	143	123	3	30102899
20,00	2	228	60	148	127	3	30102901
21,00	2	232	62	152	131	3	30102903
22,00	2	237	64	157	135	3	30102905
23,00	2	241	66	161	139	3	30102907
24,00	3	268	68	169	146	3	30102909
25,00	3	268	68	169	146	3	30102911
26,00	3	273	70	174	150	3	30102913
27,00	3	277	71	178	153	3	30102915
28,00	3	277	71	178	153	3	30102917
29,00	3	281	73	182	156	3	30102919
30,00	3	281	73	182	156	3	30102921
31,00	3	285	75	186	160	3	30102923
32,00	4	317	77	193	166	3	30102925

Dimensions in mm.

Cutting data see page 367 ff.

Information on special designs and other coatings on request.

Helical machine reamer | 030310

Configurable series with Morse taper shank

Design:

Diameter: 4,751-32,200 mm
 Cutting direction: Right-hand cutting
 Cutting material: HSS-E, uncoated
 Flute direction: Spiral fluted (approx. 45° left)

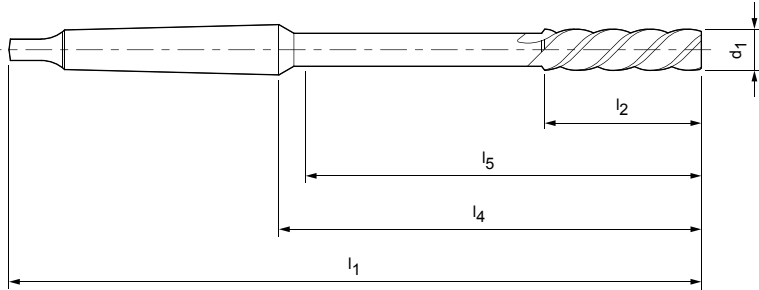

Dimensions						z
d_1	MK	l_1	l_2	l_4	l_5	
4,751-5,300	1	133	23	67,5	53	3
5,301-6,050	1	138	26	72,5	57	3
6,051-6,700	1	144	28	78,5	63	3
6,701-7,500	1	150	31	84,5	68	3
7,501-8,500	1	156	33	90,5	73	3
8,501-9,500	1	162	36	96,5	80	3
9,501-10,600	1	168	38	102,5	85	3
10,601-11,800	1	175	41	109,5	93	3
11,801-12,200	1	182	44	116,5	100	3
12,201-13,200	1	182	44	116,5	100	3
13,201-14,100	1	189	47	123,5	106	3
14,101-15,100	2	204	50	124	104	3
15,101-16,100	2	210	52	130	110	3
16,101-17,100	2	214	54	134	115	3
17,101-18,100	2	219	56	139	119	3
18,101-19,100	2	223	58	143	123	3
19,101-20,100	2	228	60	148	127	3
20,101-21,200	2	232	62	152	131	3
21,201-22,400	2	237	64	157	135	3
22,401-23,600	2	241	66	161	139	3
23,601-25,100	3	268	68	169	146	3
25,101-26,500	3	273	70	174	150	3
26,501-28,100	3	277	71	178	153	3
28,101-30,100	3	281	73	182	156	3
30,101-31,500	3	285	75	186	160	3
31,501-32,200	4	317	77	193	166	3

Dimensions in mm.

Cutting data see page 367 ff.

Information on special designs and other coatings on request.

Bridge reamer I 030010

Preferred series

Design:

Diameter: 6,40-40,00 mm
 Cutting direction: Right-hand cutting
 Cutting material: HSS, uncoated
 Flute direction: Spiral fluted

Special feature:

Lead approx.
 1:10 taper on lead length l_6

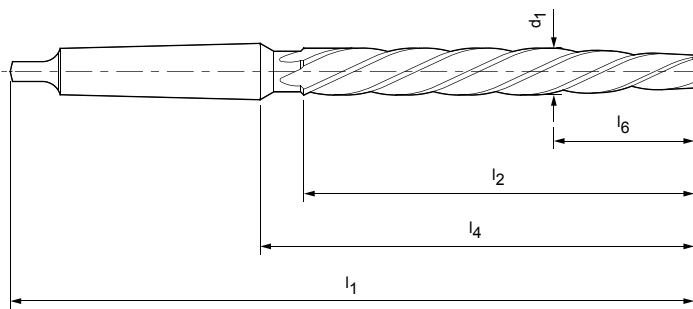

Dimensions						z	Order No.
d_1 k11	MK	l_1	l_2	l_4	l_6		
6,40	1	151	75	85,5	19	3	30102602
7,40	1	156	80	90,5	22	3	30102604
8,40	1	161	85	95,5	25	3	30102606
9,50	1	166	90	100,5	27	4	30102608
10,00	1	171	95	105,5	30	4	30102610
11,00	1	176	100	110,5	33	4	30102612
12,00	2	199	105	119	39	4	30102614
13,00	2	199	105	119	39	4	30102616
14,00	2	209	115	129	42	4	30102618
15,00	2	219	125	139	45	4	30102620
16,00	2	229	135	149	48	4	30102622
17,00	3	251	135	152	51	4	30102624
18,00	3	261	145	162	58	4	30102626
19,00	3	261	145	162	58	4	30102628
20,00	3	271	155	172	62	4	30102630
21,00	3	271	155	172	62	4	30102632
22,00	3	281	165	182	66	4	30102634
23,00	3	281	165	182	66	4	30102636
24,00	3	296	180	197	72	4	30102638
25,00	3	296	180	197	72	4	30102640
26,00	3	296	180	197	72	4	30102642
27,00	3	311	195	212	78	4	30102644
28,00	3	311	195	212	78	5	30102646
30,00	3	311	195	212	78	5	30102648
31,00	3	326	210	227	84	5	30102650
32,00	4	354	210	230	84	5	30102652
33,00	4	354	210	230	84	5	30102654
34,00	4	364	220	240	88	5	30102656
37,00	4	364	220	240	88	5	30102658
40,00	4	374	230	250	92	5	30102660

Dimensions in mm.

Cutting data see page 367 ff.

Information on special designs and other coatings on request.

Machine end face reamer WN141 030810

Preferred series

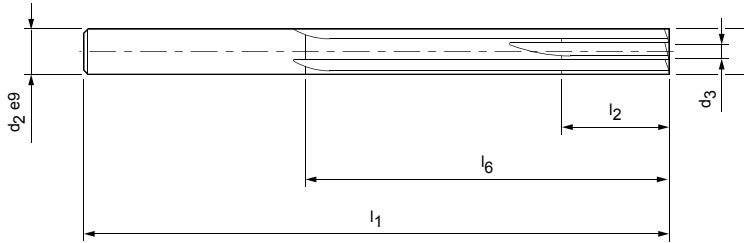

Design:

Diameter: 2,50-12,00 mm
 Cutting direction: Right-hand cutting
 Cutting material: HSS-E, uncoated
 Flute direction: Straight fluted

Special feature:

Face cutting



Dimensions						z	Order No.
d_1 H7	d_2 e9	d_3	l_1	l_2	l_6		
2,50	2,5		57	12	33	4	30107503
3,00	3	1,5	61	12	33	6	30107504
3,50	3,5	1,5	70	12	39	6	30107505
4,00	4	1,7	75	16	44	6	30107506
4,50	4,5	1,7	80	16	48	6	30107508
5,00	5	1,7	86	20	53	6	30107510
5,50	5,5	2	93	20	59	6	30312212
6,00	6	2	93	20	59	6	30107512
6,50	6,5	2	101	20	65	6	30312214
7,00	7	2,5	109	22	69	6	30107514
7,50	7,5	2,5	109	22	69	6	30312215
8,00	8	3	117	24	71	6	30107516
8,50	8,5	3	117	24	71	6	30312216
9,00	9	3,5	125	24	77	6	30107518
9,50	9,5	3,5	125	24	77	6	30312232
10,00	10	4,5	133	26	84	6	30107520
11,00	11	4,5	142	26	89	6	30107522
12,00	12	4,5	151	26	96,5	6	30107524

Dimensions in mm.

Cutting data see page 367 ff.

Information on special designs and other coatings on request.

Machine end face reamer WN141 030810

Configurable series

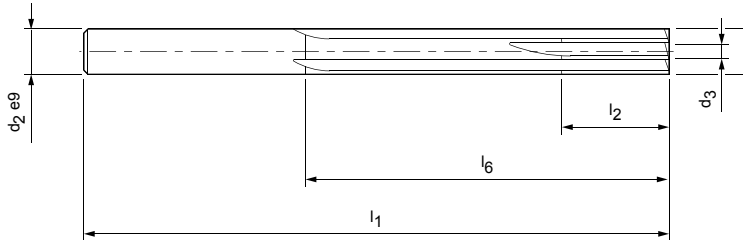
**Design:**

Diameter: 2,200-12,220 mm
 Cutting direction: Right-hand cutting
 Cutting material: HSS-E, uncoated
 Flute direction: Straight fluted

Special feature:

Face cutting



Dimensions						z
d_1	$d_2 e9$	d_3	l_1	l_2	l_6	
2,200-2,690	2,5		57	12	33	4
2,691-3,100	3	1,5	61	12	33	6
3,101-3,650	3,5	1,5	70	12	39	6
3,651-4,200	4	1,7	75	16	44	6
4,201-4,700	4,5	1,7	80	16	48	6
4,701-5,200	5	1,7	86	20	53	6
5,201-5,700	5,5	2	93	20	59	6
5,701-6,110	6	2	93	20	59	6
6,111-6,700	6,5	2	101	20	65	6
6,701-7,200	7	2,5	109	22	69	6
7,201-7,630	7,5	2,5	109	22	69	6
7,631-8,200	8	3	117	24	71	6
8,201-8,630	8,5	3	117	24	71	6
8,631-9,200	9	3,5	125	24	77	6
9,201-9,630	9,5	3,5	125	24	77	6
9,631-10,200	10	4,5	133	26	84	6
10,201-11,200	11	4,5	142	26	89	6
11,201-12,220	12	4,5	151	26	96,5	6

Dimensions in mm.

Cutting data see page 367 ff.

Information on special designs and other coatings on request.

Machine end face reamer WN142 030811

Preferred series

Design:

Diameter: 3,00-32,00 mm
Cutting direction: Right-hand cutting
Cutting material: HSS-E, uncoated
Flute direction: Straight fluted

Special feature:

Face cutting

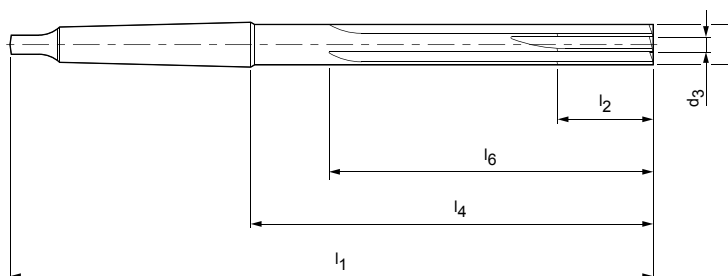

Dimensions							z	Order No.
d_1 H7	MK	d_3	l_1	l_2	l_4	l_6		
3,00	1	1,5	114	12	48,5	33	6	30107526
3,50	1	1,5	120	12	54,5	39	6	30107527
4,00	1	1,7	124	16	58,5	44	6	30107528
4,50	1	1,7	128	16	62,5	48	6	30107530
5,00	1	1,7	133	20	67,5	53	6	30107532
5,50	1	2	138	20	72,5	59	6	30316948
6,00	1	2	138	20	72,5	59	6	30107534
6,50	1	2	144	20	78,5	65	6	30316951
7,00	1	2,5	150	22	84,5	69	6	30107536
7,50	1	2,5	150	22	84,5	69	6	30316954
8,00	1	3	156	24	90,5	71	6	30107538
8,50	1	3	156	24	90,5	71	6	30316955
9,00	1	3,5	162	24	96,5	77	6	30107540
9,50	1	3,5	162	24	96,5	77	6	30316957
10,00	1	4,5	168	26	102,5	84	6	30107542
10,50	1	4,5	168	26	102,5	84	6	30316958
11,00	1	4,5	175	26	109,5	89,5	6	30107544
11,50	1	4,5	175	26	109,5	89,5	6	30316959
12,00	1	4,5	182	26	116,5	96,5	6	30107546
13,00	1	4,5	182	26	116,5	96,5	6	30107548
14,00	1	5	189	28	123,5	103,5	8	30107550
15,00	2	5	204	28	124	104	8	30107552
16,00	2	6	210	30	130	108	8	30107554
17,00	2	6	214	30	134	112	8	30107556
18,00	2	6	219	30	139	117	8	30107558
19,00	2	8	223	32	143	119	8	30107560
20,00	2	8	228	32	148	124	8	30107562
21,00	2	8	232	32	152	128	8	30107564
22,00	2	10	237	34	157	133	8	30107566
24,00	3	10	268	34	169	139	8	30107568
25,00	3	12	268	36	169	139	8	30107570
26,00	3	12	273	36	174	144	8	30107572
27,00	3	14	277	38	178	148	10	30330852
28,00	3	14	277	38	178	148	10	30107574
29,00	3	14	281	42	182	150	10	30137427
30,00	3	16	281	42	182	150	10	30107576
31,00	3	16	285	44	186	154	10	30107578
32,00	4	16	317	44	193	157	10	30107579

Dimensions in mm.

Cutting data see page 367 ff.

Information on special designs and other coatings on request.

Machine end face reamer WN142 030811

Configurable series

Design:

Diameter: 2,690-32,200 mm
 Cutting direction: Right-hand cutting
 Cutting material: HSS-E, uncoated
 Flute direction: Straight fluted

Special feature:

Face cutting

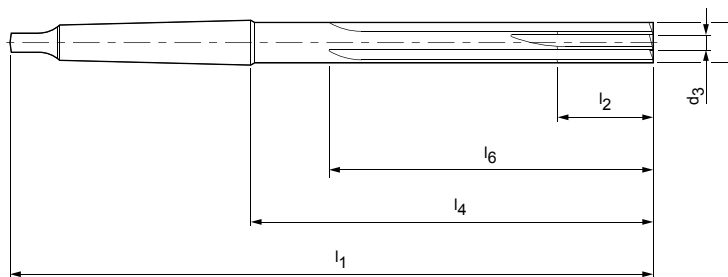

Dimensions							z
d ₁	MK	d ₃	l ₁	l ₂	l ₄	l ₆	
2,690-3,100	1	1,5	114	12	48,5	33	6
3,101-3,650	1	1,5	120	12	54,5	39	6
3,651-4,200	1	1,7	124	16	58,5	44	6
4,201-4,700	1	1,7	128	16	62,5	48	6
4,701-5,200	1	1,7	133	20	67,5	53	6
5,201-5,700	1	2	138	20	72,5	59	6
5,701-6,110	1	2	138	20	72,5	59	6
6,111-6,700	1	2	144	20	78,5	65	6
6,701-7,200	1	2,5	150	22	84,5	69	6
7,201-7,630	1	2,5	150	22	84,5	69	6
7,631-8,200	1	3	156	24	90,5	71	6
8,201-8,630	1	3	156	24	90,5	71	6
8,631-9,200	1	3,5	162	24	96,5	77	6
9,201-9,630	1	3,5	162	24	96,5	77	6
9,631-10,200	1	4,5	168	26	102,5	84	6
10,201-10,690	1	4,5	168	26	102,5	84	6
10,691-11,200	1	4,5	175	26	109,5	89,5	6
11,201-11,800	1	4,5	175	26	109,5	89,5	6
11,801-12,200	1	4,5	182	26	116,5	96,5	6
12,201-13,200	1	4,5	182	26	116,5	96,5	6
13,201-14,140	1	5	189	28	123,5	103,5	8
14,141-15,140	2	5	204	28	124	104	8
15,141-16,140	2	6	210	30	130	108	8
16,141-17,140	2	6	214	30	134	112	8
17,141-18,140	2	6	219	30	139	117	8
18,141-19,160	2	8	223	32	143	119	8
19,161-20,160	2	8	228	32	148	124	8
20,161-21,200	2	8	232	32	152	128	8
21,201-22,200	2	10	237	34	157	133	8
22,201-24,200	3	10	268	34	169	139	8
24,201-25,160	3	12	268	36	169	139	8
25,161-26,200	3	12	273	36	174	144	8
26,201-27,200	3	14	277	38	178	148	10
27,201-28,160	3	14	277	38	178	148	10
28,161-29,200	3	14	281	42	182	150	10
29,201-30,160	3	16	281	42	182	150	10
30,161-31,200	3	16	285	44	186	154	10
30,201-32,200	4	16	317	44	193	157	10

Dimensions in mm.

Cutting data see page 367 ff.

Information on special designs and other coatings on request.





MANUAL REAMING

Introduction

Product overview	286
------------------------	-----

Hand reamers

DIN 206 A	010010	288
DIN 206 B	010011	292
DIN 859 A	011010	296
DIN 859 B	011011	296
Quick adjustment reamer WN 50	012011	300
Set quick adjustment reamers WN 50	012015, 012016	300
Spare parts WN 50	012013, 012014	301

Taper reamers

DIN 2179	021010	302
DIN 2180	021011	303
DIN 9 B	020011	304
DIN 204 A	024011	305

PRODUCT OVERVIEW







Hand and taper reamers

The manual machining of bores with difficult access or tapered transitions requires tools that are easy to adapt to the respective machining situations. Despite the manual machining operation, BECK hand or taper reamers achieve high surface finishes and good cutting data. High-quality HSS steel, in-house hardening shop, high availability from stock and strict quality tests are a matter of course at BECK. Above all the high

quality of the grinding ensures a high accuracy and the best surface finishes for small and medium machining quantities.

BECK hand and taper reamers are available from stock with a diameter up to 60 mm depending on the type of tool. In addition replacement blade sets are also available for BECK quick adjustable reamers.



Hand reamers DIN 206	Hand reamers DIN 859	Quick adjustable reamers WN 50
		
<p>Fixed design, straight and spiral fluted. The straight fluted version is being discontinued (delivery as long as stocks last).</p> <p>Ø range: 1.00 - 60.00 mm</p> 	<p>Adjustable design.</p> <p>Ø range: 4.00 - 60.00 mm</p> 	<p>With large adjusting range. Particularly suitable for repair work.</p> <p>Ø range: 6.40 - 95.00 mm</p> 
Page 288	Page 296	Page 300



Helical machine taper reamers DIN 2179 and DIN 2180



With taper 1:50. For taper pins in accordance to DIN 1, DIN 258, DIN 7977 and DIN 7978.

Ø range: 1.00 - 12.00 mm or 5.00 - 50.00 mm



Hand taper reamers DIN 9



Form B, spiral fluted, with taper 1:50. For taper pins in accordance to DIN 1, DIN 258, DIN 7977 and DIN 7978.

Ø range: 3.00 - 50.00 mm



Hand taper reamers DIN 204



Form A, straight fluted. For finish-reaming of bores for Morse taper.

MK range: 1-6



Hand reamer DIN 206 I 010010

Preferred series with long cutting section, cylindrical shank and square end
(Wrench size "sw" see table)

Design:

Diameter:
Cutting direction:
Cutting material:
Flute direction:

1,00-60,00 mm
Right-hand cutting
HSS
Straight fluted

Special feature:

Discontinuing
production!
Available only
until supply lasts!

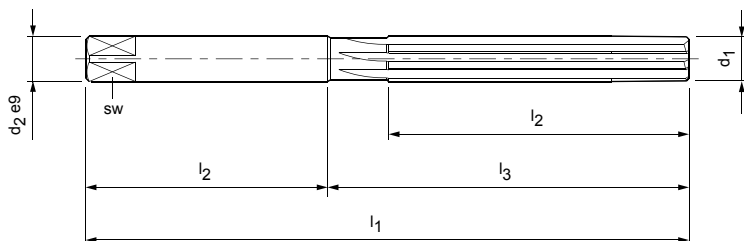

Dimensions				sw	z	Order No.
d ₁ H7	d ₂ e9	l ₁	l ₂			
1,00	1	34	13	-	3	10070710
1,10	1,1	34	13	-	3	10070711
1,30	1,3	38	17	-	3	10070713
1,50	1,5	41	20	1,12	3	10070715
1,60	1,6	44	21	1,25	3	10070716
1,80	1,8	47	23	1,4	4	10070718
2,00	2	50	25	1,6	4	30101631
2,20	2,2	54	27	1,8	4	30101633
2,50	2,5	58	29	2,1	4	30101636
2,80	2,8	62	31	2,1	6	30101639
3,00	3	62	31	2,4	6	30101651
3,20	3,2	66	33	2,4	6	30101653
3,50	3,5	71	35	2,7	6	30101655
4,00	4	76	38	3	6	30101663
4,50	4,5	81	41	3,4	6	30101673
5,00	5	87	44	3,8	6	30101683
5,50	5,5	93	47	4,3	6	30101693
6,00	6	93	47	4,9	6	30101703
6,50	6,5	100	50	4,9	6	30101711
7,00	7	107	54	5,5	6	30101721
7,50	7,5	107	54	6,2	6	30101731
8,00	8	115	58	6,2	6	30101741
8,50	8,5	115	58	7	6	30101751
9,00	9	124	62	7	6	30101759
9,50	9,5	124	62	8	6	30101767
10,00	10	133	66	8	6	30101777
10,50	10,5	133	66	8	6	30101783
11,00	11	142	71	9	6	30101793
11,50	11,5	142	71	9	6	30101803
12,00	12	152	76	9	6	30101813
12,50	12,5	152	76	10	6	30101815
13,00	13	152	76	10	6	30101817
13,50	13,5	163	81	11	8	30101819
14,00	14	163	81	11	8	30101821
14,50	14,5	163	81	11	8	30101823
15,00	15	163	81	12	8	30101825
15,50	15,5	175	87	12	8	30101827
16,00	16	175	87	12	8	30101829
16,50	16,5	175	87	13	8	30101831

Hand reamer DIN 206 I 010010, preferred series

Dimensions				sw	z	Order No.
d ₁ H7	d ₂ e9	l ₁	l ₂			
17,00	17	175	87	13	8	30101833
17,50	17,5	188	93	14,5	8	30101835
18,00	18	188	93	14,5	8	30101837
18,50	18,5	188	93	14,5	8	30101839
19,00	19	188	93	14,5	8	30101841
19,50	19,5	201	100	16	8	30101843
20,00	20	201	100	16	8	30101845
21,00	21	201	100	16	8	30101847
22,00	22	215	107	18	8	30101849
23,00	23	215	107	18	8	30101851
24,00	24	231	115	20	8	30101853
25,00	25	231	115	20	8	30101855
26,00	26	231	115	20	8	30101857
27,00	27	247	124	22	10	30101859
28,00	28	247	124	22	10	30101861
29,00	29	247	124	22	10	30101863
30,00	30	247	124	24	10	30101865
31,00	31	265	133	24	10	30101867
32,00	32	265	133	24	10	30101869
33,00	33	265	133	26	10	30101871
34,00	34	284	142	26	10	30101873
35,00	35	284	142	29	10	30101875
36,00	36	284	142	29	10	30101877
37,00	37	284	142	29	10	30101879
38,00	38	305	152	29	10	30101881
39,00	39	305	152	32	10	30101883
40,00	40	305	152	32	10	30101885
45,00	45	326	163	35	12	30101890
50,00	50	347	174	39	12	30101899
60,00	60	367	184	49	12	30101901

Hand reamer DIN 206 I 010010

Configurable series with long cutting section, cylindrical shank and square end
(Wrench size "sw" see table)

Design:

Diameter: 0,950-60,200 mm
Cutting direction: Right-hand cutting
Cutting material: HSS
Flute direction: Straight fluted

Special feature:

Discontinuing production!
Available only until supply lasts!

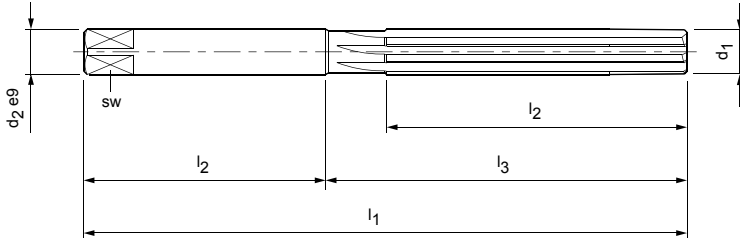

Dimensions			sw	z
d_1	l_1	l_2		
0,950-1,090	34	13	-	3
1,091-1,190	34	13	-	3
1,191-1,390	38	17	-	3
1,191-1,590	41	20	1,12	3
1,591-1,790	44	21	1,25	3
1,791-1,980	47	23	1,4	4
1,981-2,120	50	25	1,6	4
2,121-2,390	54	27	1,8	4
2,391-2,690	58	29	2,1	4
2,691-2,890	62	31	2,1	6
2,891-3,100	62	31	2,4	6
3,101-3,300	66	33	2,4	6
3,301-3,600	71	35	2,7	6
3,601-4,200	76	38	3	6
4,201-4,700	81	41	3,4	6
4,701-5,200	87	44	3,8	6
5,201-5,600	93	47	4,3	6
5,601-6,100	93	47	4,9	6
6,101-6,700	100	50	4,9	6
6,701-7,100	107	54	5,5	6
7,101-7,600	107	54	6,2	6
7,601-8,100	115	58	6,2	6
8,101-8,600	115	58	7	6
8,601-9,100	124	62	7	6
9,101-9,600	124	62	8	6
9,601-10,100	133	66	8	6
10,101-10,600	133	66	8	6
10,601-11,100	142	71	9	6
11,101-11,600	142	71	9	6
11,601-12,300	152	76	9	6
12,301-12,550	152	76	10	6
12,551-13,200	152	76	10	6
13,201-13,550	163	81	11	8
13,551-14,200	163	81	11	8
14,201-14,550	163	81	11	8
14,551-15,100	163	81	12	8
15,101-15,800	175	87	12	8
15,801-16,200	175	87	12	8
16,201-16,700	175	87	13	8

Hand reamer DIN 206 I 010010, configurable series

Dimensions			SW	Z
d ₁	l ₁	l ₂		
16,701-17,100	175	87	13	8
17,101-17,550	188	93	14,5	8
17,551-18,200	188	93	14,5	8
18,201-18,600	188	93	14,5	8
18,601-19,100	188	93	14,5	8
19,101-19,800	201	100	16	8
19,801-20,200	201	100	16	8
20,201-21,200	201	100	16	8
21,201-22,200	215	107	18	8
22,201-23,200	215	107	18	8
23,201-24,200	231	115	20	8
24,201-25,200	231	115	20	8
25,201-26,200	231	115	20	8
26,201-27,200	247	124	22	10
27,201-28,200	247	124	22	10
28,201-29,200	247	124	22	10
29,201-30,200	247	124	24	10
30,201-31,200	265	133	24	10
31,201-32,200	265	133	24	10
32,201-33,200	265	133	26	10
33,201-34,200	284	142	26	10
34,201-35,200	284	142	29	10
35,201-36,200	284	142	29	10
36,201-37,200	284	142	29	10
37,201-38,200	305	152	29	10
38,201-39,200	305	152	32	10
39,201-40,200	305	152	32	10
44,201-45,200	326	163	35	12
49,201-50,200	347	174	39	12
58,201-60,200	367	184	49	12

Hand reamer DIN 206 I 010011

Preferred series with long cutting section, cylindrical shank and square end
(Wrench size "sw" see table)

Design:

Diameter:

Cutting direction:

Cutting material:

Flute direction:

1,00-60,00 mm

Right-hand cutting

HSS

Spiral fluted

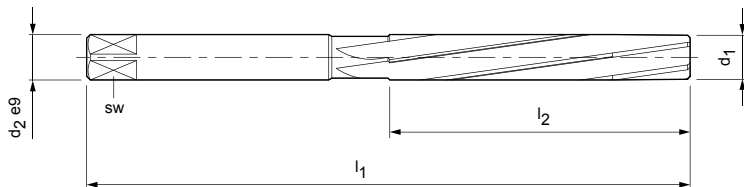

Dimensions				sw	z	Order No.
$d_1 H7$	$d_2 e9$	l_1	l_2			
1,00	1	34	13		3	10070720
1,10	1,1	34	13		3	10070721
1,20	1,2	38	17		3	30611590
1,30	1,3	38	17		3	10070722
1,40	1,4	41	20	1,12	3	10070723
1,50	1,5	41	20	1,12	3	10070724
1,60	1,6	44	21	1,25	3	10070725
1,80	1,8	47	23	1,4	4	10070726
2,00	2	50	25	1,6	4	30101902
2,20	2,2	54	27	1,8	4	30101904
2,50	2,5	58	29	2	4	30101905
2,80	2,8	62	31	2,4	6	30101908
3,00	3	62	31	2,4	6	30101909
3,20	3,2	66	33	2,4	6	30345568
3,50	3,5	71	35	2,7	6	30101911
4,00	4	76	38	3	6	30101918
4,50	4,5	81	41	3,4	6	30101926
5,00	5	87	44	3,8	6	30101932
5,50	5,5	93	47	4,3	6	30101936
6,00	6	93	47	4,3	6	30101942
6,50	6,5	100	50	4,9	6	30101944
7,00	7	107	54	5,5	6	30101950
7,50	7,5	107	54	5,5	6	30101958
8,00	8	115	58	6,2	6	30101966
8,50	8,5	115	58	6,2	6	30101970
9,00	9	124	62	7	6	30101980
9,50	9,5	124	62	7	6	30101990
10,00	10	133	66	8	6	30101996
10,50	10,5	133	66	8	6	30101998
11,00	11	142	71	9	6	30102008
11,50	11,5	142	71	9	6	30102018
12,00	12	152	76	9	6	30102024
12,50	12,5	152	76	10	6	30102026
13,00	13	152	76	10	6	30102028
13,50	13,5	163	81	11	8	30102030
14,00	14	163	81	11	8	30102032
14,50	14,5	163	81	12	8	30102034
15,00	15	163	81	12	8	30102036
15,50	15,5	175	87	12	8	30102038

Hand reamer DIN 206 I 010011, preferred series

Dimensions				sw	z	Order No.
d ₁ H7	d ₂ e9	l ₁	l ₂			
16,00	16	175	87	12	8	30102040
16,50	16,5	175	87	13	8	30102042
17,00	17	175	87	13	8	30102044
17,50	17,5	188	93	14,5	8	30102046
18,00	18	188	93	14,5	8	30102048
18,50	18,5	188	93	14,5	8	30102050
19,00	19	188	93	14,5	8	30102052
19,50	19,5	201	100	16	8	30102054
20,00	20	201	100	16	8	30102056
21,00	21	201	100	16	8	30102058
22,00	22	215	107	18	8	30102060
23,00	23	215	107	18	8	30102062
24,00	24	231	115	18	8	30102064
25,00	25	231	115	20	8	30102066
26,00	26	231	115	20	8	30102068
27,00	27	247	124	22	10	30102070
28,00	28	247	124	22	10	30102072
29,00	29	247	124	22	10	30102074
30,00	30	247	124	22	10	30102076
31,00	31	265	133	24	10	30102078
32,00	32	265	133	24	10	30102080
33,00	33	265	133	26	10	30102082
34,00	34	284	142	26	10	30102084
35,00	35	284	142	26	10	30102086
36,00	36	284	142	29	10	30102088
37,00	37	284	142	29	10	30102090
38,00	38	305	152	29	10	30102092
39,00	39	305	152	29	10	30102094
40,00	40	305	152	32	10	30102096
45,00	45	326	163	35	12	30102100
50,00	50	347	174	39	12	30102103
60,00	60	367	184	49	12	30102105

Hand reamer DIN 206 I 010011

Configurable series with long cutting section, cylindrical shank and square end
(Wrench size "sw" see table)

Design:

Diameter:

0,950-60,200 mm

Cutting direction:

Right-hand cutting

Cutting material:

HSS

Flute direction:

Spiral fluted

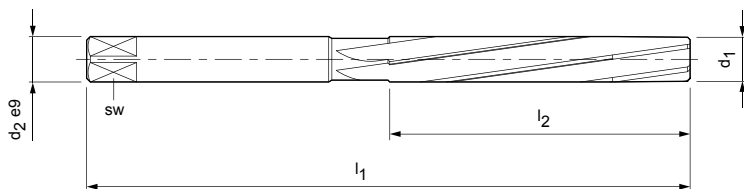

Dimensions*			sw	z
d_1	l_1	l_2		
0,950-1,060	34	13		3
1,061-1,180	34	13		3
1,181-1,320	38	17		3
1,321-1,410	41	20	1,12	3
1,411-1,500	41	20	1,12	3
1,501-1,700	44	21	1,25	3
1,701-1,900	47	23	1,4	4
1,901-2,120	50	25	1,6	4
2,121-2,360	54	27	1,8	4
2,361-2,650	58	29	2	4
2,651-3,000	62	31	2,4	6
3,001-3,300	66	33	2,4	6
3,301-3,600	71	35	2,7	6
3,601-4,200	76	38	3	6
4,201-4,700	81	41	3,4	6
4,701-5,200	87	44	3,8	6
5,201-5,600	93	47	4,3	6
5,601-6,100	93	47	4,3	6
6,101-6,700	100	50	4,9	6
6,701-7,100	107	54	5,5	6
7,101-7,600	107	54	5,5	6
7,601-8,100	115	58	6,2	6
8,101-8,600	115	58	6,2	6
8,601-9,100	124	62	7	6
9,101-9,600	124	62	7	6
9,601-10,100	133	66	8	6
10,101-10,600	133	66	8	6
10,601-11,100	142	71	9	6
11,101-11,600	142	71	9	6
11,601-12,300	152	76	9	6
12,301-13,200	152	76	10	6
13,201-14,200	163	81	11	8
14,201-15,100	163	81	12	8
15,100-16,200	175	87	12	8
16,201-17,200	175	87	13	8
18,201-18,200	188	93	14,5	8
18,201-19,100	188	93	14,5	8
19,101-20,200	201	100	16	8
20,201-21,200	201	100	16	8

Hand reamer DIN 206 I 010011, configurable series

Dimensions*			SW	Z
d ₁	l ₁	l ₂		
21,201-22,200	215	107	18	8
22,201-23,200	215	107	18	8
23,201-24,200	231	115	18	8
24,201-25,200	231	115	20	8
25,201-26,200	231	115	20	8
26,201-27,200	247	124	22	10
27,201-28,200	247	124	22	10
28,201-30,200	247	124	22	10
30,201-32,200	265	133	24	10
32,200-33,200	265	133	26	10
33,201-35,200	284	142	26	10
35,201-37,200	284	142	29	10
37,201-39,200	305	152	29	10
39,201-40,200	305	152	32	10
43,000-45,200	326	163	35	12
48,000-50,200	347	174	39	12
58,000-60,200	367	184	49	12

(*) Intermediate diameters, which are not listed in these tables can be produced as custom design on request.
Dimensions in mm.

Hand reamer I 011010, 011011

Preferred series, adjustable, with long cutting section, cylindrical shank and square end
(Wrench size "sw" see table)

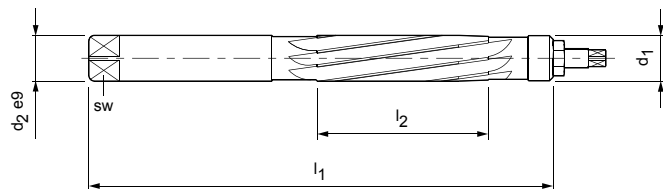
**Design:**

Diameter:
Cutting direction:
Cutting material:
Flute direction:

011010

4,00-5,50 mm
Right-hand cutting
HSS
Straight fluted

Design:

Diameter:
Cutting direction:
Cutting material:
Flute direction:

011011

6,00-60,00 mm
Right-hand cutting
HSS
Spiral fluted

Special feature:

Adjustment range
approx. 1/100 of d_1



Dimensions				sw	z	Order No.
d_1	$d_2 e9$	l_1	l_2			
4,00	4	76	24	3	6	30102107
4,50	4,5	81	27	3,4	6	30102109
5,00	5	87	30	3,8	6	30102111
5,50	5,5	93	33	4,3	6	30102113
6,00	6	93	33	4,9	6	30102239
6,50	6,5	100	34	4,9	6	30102241
7,00	7	107	38	5,5	9	30102243
7,50	7,5	107	38	6,2	9	30102245
8,00	8	115	42	6,2	9	30102247
8,50	8,5	115	42	7	9	30102249
9,00	9	124	46	7	9	30102251
9,50	9,5	124	46	8	9	30102253
10,00	10	133	50	8	9	30102255
10,50	10,5	133	50	8	9	30102257
11,00	11	142	51	9	9	30102259
11,50	11,5	142	51	9	9	30102261
12,00	12	152	56	9	9	30102263
12,50	12,5	152	56	10	9	30102265
13,00	13	152	56	10	9	30102267
13,50	13,5	163	61	11	9	30102269
14,00	14	163	61	11	9	30102271
14,50	14,5	163	61	11	9	30102273
15,00	15	163	61	12	9	30102275
15,50	15,5	175	67	12	9	30102277
16,00	16	175	67	12	9	30102279
16,50	16,5	175	67	13	9	30102281
17,00	17	175	67	13	9	30102283
17,50	17,5	188	68	14,5	9	30137431
18,00	18	188	68	14,5	9	30102285
18,50	18,5	188	68	14,5	9	30102286
19,00	19	188	68	14,5	9	30102288
19,50	19,5	201	75	16	9	30102289
20,00	20	201	75	16	9	30102291
21,00	21	201	75	16	9	30331489
22,00	22	215	82	18	12	30102293
23,00	23	215	82	18	12	30331490
24,00	24	231	85	18	12	30102295
25,00	25	231	85	20	12	30102297
26,00	26	231	85	20	12	30102299

Hand reamer, adjustable DIN 859 I 011011, preferred series

Dimensions				sw	z	Order No.
d ₁	d ₂ e9	l ₁	l ₂			
27,00	27	247	94	22	12	30102300
28,00	28	247	94	22	12	30102302
29,00	29	247	94	22	12	30102304
30,00	30	247	94	24	12	30102306
31,00	31	265	99	24	12	30102308
32,00	32	265	99	24	12	30102310
33,00	33	265	99	26	12	30331491
34,00	34	284	108	26	12	30102312
35,00	35	284	108	29	12	30102314
36,00	36	284	108	29	12	30102316
37,00	37	284	108	29	12	30331493
38,00	38	305	111	29	12	30102318
39,00	39	305	111	32	12	30102319
40,00	40	305	111	32	12	30102321
41,00	41	305	111	32	12	30102322
42,00	42	305	111	32	12	30331494
43,00	43	326	120	35	12	30331495
44,00	44	326	120	35	12	30331496
45,00	45	326	120	35	12	30102324
46,00	46	326	120	35	12	30102326
47,00	47	326	120	39	12	30331497
48,00	48	347	131	39	12	30331498
49,00	49	347	131	39	12	30102328
50,00	50	347	131	39	12	30102330
51,00	51	347	131	39	16	30331499
52,00	52	347	131	39	16	30331500
53,00	53	347	131	44	16	30331501
54,00	54	367	134	44	16	30331502
55,00	55	367	134	44	16	30102332
56,00	56	367	134	44	16	30331503
57,00	57	367	134	44	16	30331504
58,00	58	367	134	44	16	30102333
59,00	59	367	134	49	16	30331505
60,00	60	367	134	49	16	30102335

Hand reamer I 011010, 011011

Configurable series, adjustable with long first cut, cylindrical shank and square end
(Wrench size "sw" see table)

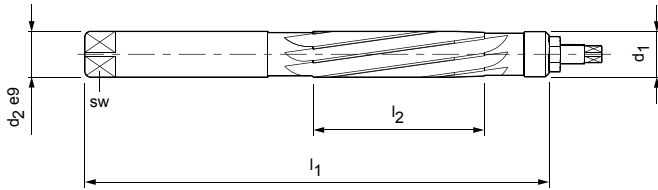
**Design:**

Diameter:
Cutting direction:
Cutting material:
Flute direction:

011010

3,900-5,700 mm
Right-hand cutting
HSS
Straight fluted

Design:

Diameter:
Cutting direction:
Cutting material:
Flute direction:

011011

5,701-60,200 mm
Right-hand cutting
HSS
Spiral fluted

Special feature:

Adjustment range
approx. 1/100 of d_1



Dimensions			sw	z
d_1	l_1	l_2		
3,900-4,200	76	24	3	6
4,201-4,700	81	27	3,4	6
4,701-5,200	87	30	3,8	6
5,201-5,700	93	33	4,3	6
5,701-6,200	93	33	4,9	6
6,201-6,700	100	34	4,9	6
6,701-7,200	107	38	5,5	9
7,201-7,630	107	38	6,2	9
7,631-8,200	115	42	6,2	9
8,201-8,630	115	42	7	9
8,631-9,200	124	46	7	9
9,201-9,630	124	46	8	9
9,631-10,200	133	50	8	9
10,201-10,600	133	50	8	9
10,601-11,200	142	51	9	9
11,201-11,800	142	51	9	9
11,801-12,400	152	56	9	9
12,401-13,200	152	56	10	9
13,201-13,640	163	61	11	9
13,641-14,140	163	61	11	9
14,141-14,640	163	61	11	9
14,641-15,140	163	61	12	9
15,141-15,640	175	67	12	9
15,641-16,140	175	67	12	9
16,141-16,640	175	67	13	9
16,641-17,140	175	67	13	9
17,141-17,640	188	68	14,5	9
17,641-18,140	188	68	14,5	9
18,141-18,640	188	68	14,5	9
18,641-19,160	188	68	14,5	9
19,161-19,660	201	75	16	9
19,661-20,160	201	75	16	9
20,161-21,200	201	75	16	9
21,201-22,200	215	82	18	12
22,201-23,200	215	82	18	12
23,201-24,200	231	85	18	12
24,201-25,200	231	85	20	12
25,201-26,200	231	85	20	12
26,201-27,200	247	94	22	12

Hand reamer, adjustable DIN 859 I 011010, 011011, configurable series

Dimensions			SW	Z
d ₁	l ₁	l ₂		
27,201-28,200	247	94	22	12
28,201-29,200	247	94	22	12
29,201-30,200	247	94	24	12
30,201-31,200	265	99	24	12
31,201-32,200	265	99	24	12
32,201-33,200	265	99	26	12
33,201-34,200	284	108	26	12
34,201-35,200	284	108	29	12
35,201-36,200	284	108	29	12
36,201-37,200	284	108	29	12
37,201-38,200	305	111	29	12
38,201-39,200	305	111	32	12
39,201-40,200	305	111	32	12
40,201-41,200	305	111	32	12
41,201-42,200	305	111	32	12
42,201-43,200	326	120	35	12
43,201-44,200	326	120	35	12
44,201-45,200	326	120	35	12
45,201-46,200	326	120	35	12
46,201-47,200	326	120	39	12
47,201-48,200	347	131	39	12
48,201-49,200	347	131	39	12
49,201-50,200	347	131	39	12
50,201-51,200	347	131	39	16
51,201-52,200	347	131	39	16
52,201-53,200	347	131	44	16
53,201-54,200	367	134	44	16
54,201-55,200	367	134	44	16
55,201-56,200	367	134	44	16
56,201-57,200	367	134	44	16
57,201-58,200	367	134	44	16
58,201-59,200	367	134	49	16
59,201-60,200	367	134	49	16

Quick adjustable reamer WN 50 | 012011

With interchangeable blades, large adjustment range, outstandingly suitable for repair work

Design:

Diameter:

Cutting direction:

Cutting material:

6,40-80,00 mm

Right-hand cutting

HSS

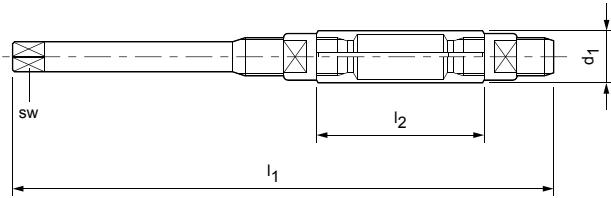

Dimensions						sw	z	Order No.
d ₁ ± 0,01	Size	∅ d ₁ -∅ d ₁ [mm]	∅ d ₁ -∅ d ₁ [inch]	l ₁	l ₂			
6,40	000	6,40-7,20	-	110	32	3	4	30102341
7,20	00	7,20-8,00	-	110	32	3,4	4	30102339
8,00	0	8,00-9,00	21/64-23/64	115	34	3,8	5	30102337
9,00	1	9,00-10,00	23/64-25/64	115	34	4,3	5	30102343
10,00	2	10,00-11,00	25/64-7/16	115	34	4,9	5	30102345
11,00	3	11,00-12,00	7/16-15/32	125	35	4,9	5	30102347
12,00	4	12,00-13,50	15/32-17/32	135	41	6,2	5	30102349
13,50	5	13,50-15,50	17/32-39/64	146	50	7	5	30102351
15,50	6	15,50-18,00	39/64-45/64	166	60	8	5	30102353
18,00	7	18,00-21,00	45/64-53/64	178	65	9	5	30102355
21,00	8	21,00-24,00	53/64-61/64	195	76	11	5	30102357
24,00	9	24,00-27,50	61/64-1 5/64	218	82	12	5	30102359
27,50	10	27,50-31,50	1 5/64-1 15/64	245	86	14,5	5	30102361
31,50	11	31,50-37,00	1 15/64-1 29/64	280	98	18	6	30102363
37,00	12	37,00-45,00	1 29/64-1 49/64	325	108	20	6	30102365
45,00	13	45,00-55,00	1 49/64-2 5/32	370	118	26	6	30102367
55,00	14	55,00-67,00	2 5/32-2 41/64	400	125	32	6	30102369
67,00	15	67,00-80,00	2 41/64-3 5/32	435	140	39	8	30102371
80,00	16	80,00-95,00	3 5/32-3 3/4	475	155	49	8	30102373

Set of quick adjustable reamers WN 50

Product code	Content	Size	Range	Order No.
012015	11 pieces	0-10	8,00-31,50 mm	30135917
012016	13 pieces	0-12	8,00-45,00 mm	30135916

Spare blades I 012013

For quick adjustable reamers WN 50
Available only as a set.

Dimensions		z	Order No.
Size	l ₁		
000	32	4	30134531
00	32	4	30134519
0	34	5	30134496
1	34	5	30134534
2	34	5	30134535
3	35	5	30134536
4	41	5	30134537
5	50	5	30134538
6	60	5	30134539
7	65	5	30134540
8	76	5	30134541
9	82	5	30134542
10	86	5	30134543
11	98	6	30134544
12	108	6	30134545
13	118	6	30134546
14	125	6	30134547
15	140	8	30134548
16	155	8	30134549

Adjustment nuts I 012014

For quick adjustable reamers WN 50

Dimensions		Order No.
Size	M	
000	M5x0,75	10070246
00	M5,5x0,75	10070245
0	M6,5x0,75	10070244
1	M7x0,75	10070247
2	M7,5x0,75	10070248
3	M8x0,75	10070249
4	M9,5x1	10070250
5	M10,5x1	10070251
6	M12,5x1,25	10070252
7	M14,5x1,25	10070253
8	M16x1,25	10070254
9	M18x1,25	10070255
10	M22x1,5	10070256
11	M25x1,5	10070257
12	M30x1,5	10070258
13	M37x1,5	10070259
14	M46x1,5	10076837
15	M55x2	10076838
16	M68x2	10076839

Helical machine taper reamer I 021010

With 1:50 taper for reaming holes for taper pins according to DIN 1, DIN 258, DIN 7977 and DIN 7978, with cylindrical shank and driving tang according to DIN 1809

Design:

Diameter:
Cutting direction:
Cutting material:
Flute direction:

1,00-12,00 mm
Right-hand cutting
HSS-E
Spiral fluted
with 45° left-hand
spiral

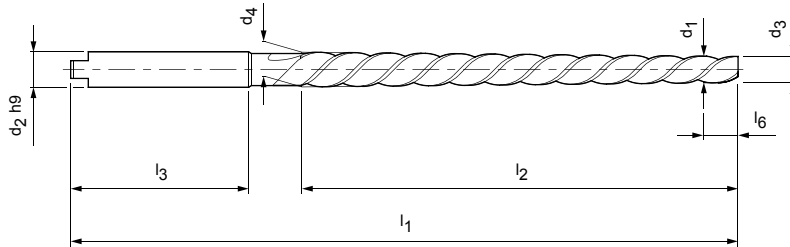

Dimensions								z	Order No.
d ₁	d ₂ h9	d ₃	d ₄	l ₁	l ₂	l ₃	l ₆		
1,00	1,4	0,8	1,46	60	33	23	10	2	30102455
1,50	2,1	1,4	2,14	70	37	29	5	2	30102456
2,00	3,15	1,9	2,86	86	48	29	5	3	30102457
2,50	3,15	2,4	3,36	86	48	29	5	3	30102458
3,00	4	2,9	4,06	100	58	32	5	3	30102459
4,00	5	3,9	5,26	112	68	34	5	3	30102461
5,00	6,3	4,9	6,36	122	73	38	5	3	30102463
6,00	8	5,9	8	160	105	42	5	3	30102465
6,50	8,5	6,4	8,78	185	119	46	5	3	30102467
8,00	10	7,9	10,8	207	145	46	5	3	30102469
10,00	12,5	9,9	13,4	245	175	50	5	3	30102471
12,00	16	11,8	16	290	210	58	10	3	30102473

Helical machine taper reamer | 021011

With 1:50 taper for reaming holes for taper pins according to DIN 1, DIN 258, DIN 7977 and DIN 7978, with Morse taper shank

Design:

Diameter:
Cutting direction:
Cutting material:
Flute direction:

5,00-50,00 mm
Right-hand cutting
HSS-E
Spiral fluted
with 45° left-hand
spiral

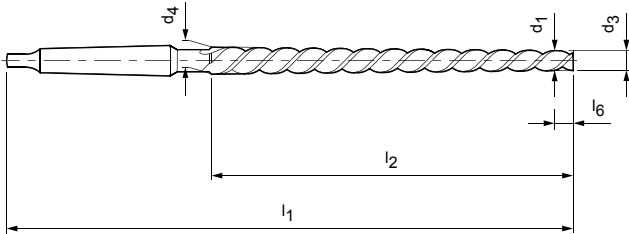

Dimensions							z	Order No.
d_1	d_3	d_4	l_1	l_2	l_6	MK		
5,00	4,9	6,36	155	73	5	1	3	30102475
6,00	5,9	8	187	105	5	1	3	30102477
8,00	7,9	10,8	227	145	5	1	3	30102479
10,00	9,9	13,4	257	175	5	1	3	30102481
12,00	11,8	16	315	210	10	2	3	30102483
13,00	12,86	16,74	295	194	10	2	3	30102485
14,00	13,86	17,74	295	194	10	2	3	30102487
16,00	15,8	20,4	335	230	10	2	3	30102489
20,00	19,8	24,8	377	250	10	3	3	30102491
25,00	24,7	30,7	427	300	15	3	3	30102493
30,00	29,7	36,1	475	320	15	4	4	30102495
40,00	39,7	46,5	495	340	15	4	6	30102497
50,00	49,7	56,9	550	360	15	5	8	30102499

Hand taper reamer I 020011

Form B, mit Kegel 1:50, with cylindrical shank and square end
(Wrench size "sw" see table) for reaming holes for taper pins to DIN 1,
DIN 258, DIN 7977 and DIN 7978

Design:

Diameter:

3,00-50,00 mm

Cutting direction:

Right-hand cutting

Cutting material:

HSS

Flute direction:

Spiral fluted

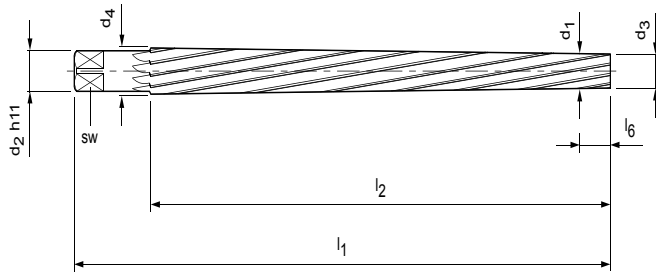

Dimensions							sw	z	Order No.
d ₁	d ₂ h11	d ₃	d ₄	l ₁	l ₂	l ₆			
3,00	4	2,9	4,06	80	58	5	3	5	30102415
3,50	4,5	3,4	4,66	87	63	5	3,4	5	30102416
4,00	5	3,9	5,26	93	68	5	3,8	5	30102418
4,50	5,6	4,4	5,8	95	70	5	4,3	5	30102420
5,00	6,3	4,9	6,36	100	73	5	4,9	5	30102422
5,50	7,1	5,4	7,2	118	90	5	5,5	6	30102424
6,00	8	5,9	8	135	105	5	6,2	6	30102426
6,50	8	6,4	8,6	140	110	5	6,2	6	30102428
7,00	9	6,9	9,4	160	125	5	7	6	30102430
8,00	10	7,9	10,8	180	145	5	8	6	30102432
9,00	11,2	8,9	12,1	195	160	5	9	6	30102434
10,00	12,5	9,9	13,4	215	175	5	10	6	30102436
12,00	14	11,8	16	255	210	10	11	8	30102438
13,00	16	12,8	17	255	210	10	12	8	30102440
14,00	16	13,8	18	255	210	10	12	8	30102442
16,00	18	15,8	20,4	280	230	10	14,5	8	30102444
20,00	22,4	19,8	24,8	310	250	10	18	8	30102446
25,00	28	24,7	30,7	370	300	15	22	10	30102448
30,00	31,5	29,7	36,1	400	320	15	24	10	30102450
40,00	40	39,7	46,5	430	340	15	32	12	30102452
50,00	50	49,7	56,9	460	360	15	39	12	30102454

Hand taper reamer I 024011

Form A, with cylindrical shank and square end (Wrench size "sw" see table), finishing reamer for morse tapers

Design:

Cutting direction:
Cutting material:
Flute direction:

Right-hand cutting
HSS
Straight fluted

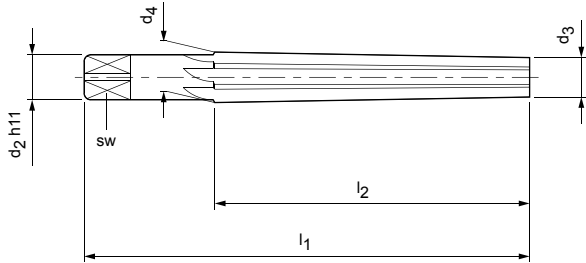

Dimensions						sw	z	Order No.
for MT	$d_2 h_{11}$	d_3	d_4	l_1	l_2			
0	8	6,547	9,722	93	61	6,2	6	30102559
1	10	9,571	12,863	102	66	8	7	30102561
2	14	14,733	18,679	121	79	11	8	30102563
3	20	20,01	24,829	146	96	16	8	30102565
4	25	26,229	32,41	179	119	20	10	30102567
5	31,5	37,873	45,767	222	150	24	12	30102569
6	45	54,172	65,016	300	208	35	14	30102571



A close-up photograph of two metal cutting tools. The top tool is a countersink bit, which has a conical tip and a cylindrical body. The bottom tool is a counterbore bit, which has a wider, flat-tipped end and a cylindrical body. Both tools are resting on a light-colored, textured surface, likely a workbench or a piece of wood.

COUNTERSINKS COUNTERBORES

Introduction

Product overview	308
------------------------	-----

Countersinks

EUC-Speed made of solid carbide and HSS	311
Countersinks 90° and 60° made of solid carbide and HSS	316

Counterbores

Counterbore made of HSS with pilots	333
---	-----

PRODUCT OVERVIEW

EUC-Speed, countersinks and counterbores

Countersinking and deburring tools form a comprehensive addition to bore machining. Countersinking operations are performed on practically all parts that have to be machined. Countersinking tools are required in particular for flush screw joints. The spectrum extends from simple deburring tools right up to high-tech countersinking tools with extremely unequal cutting edge spacing and highly wear-resistant coating.

Diameters up to 100 mm are available ex stock depending on the type of tool. Designs made of HSS, solid carbide with various coatings provide the right tool for every application. The coatings also make a significant contribution to improving the tool life and performance. Ground chip spaces ensure reliable chip removal and good support in the bore is ensured by the radial undercut.

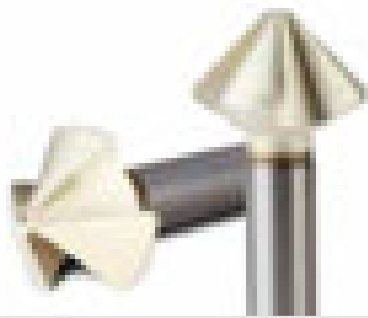

EUC-Speed

Countersinks 90° with extremely unequal cutting edge spacing. Precision design made of HSS and solid carbide with special coating.

Ø range: 4.30-31.00 mm

Perfor
mance
LINE



Countersinks 90° in accordance to DIN and works standard

With even cutting edge spacing. Precision design made of HSS and solid carbide with various coatings.

Ø range: 4.30-100.00 mm

Basic
LINE



Countersinks 60° in accordance to DIN and works standard

With even cutting edge spacing. Precision design made of HSS and HSS with TiN coating.

Ø range: 6.00-80.00 mm

Basic
LINE



Counterbores in accordance to DIN and works standard

With solid and replaceable guide pins. Designs made of HSS and HSS with TiN coating.

Ø range: 6.00-63.00 mm

Basic
LINE





COUNTERSINKS

Introduction

Product overview EUC-Speed	312
----------------------------------	-----

Countersinks EUC-Speed

EUC-Speed made of solid carbide	044210	314
EUC-Speed made of HSS	054210	315

Countersinks 90°

DIN 335 C, VHM	041020	316
DIN 335 C, HSS	051210	317
DIN 335 C, HSS, TiAlN coated	053212	318
DIN 335 C, HSS, TiN coated	053210	319
DIN 335 C, HSS with clamping surface	051207	320
DIN 335 C, HSS, TiN coated w. surface	053207	321
DIN 335 D, HSS	051310	322
DIN 335 D, HSS, TiN coated	053310	323
Hand deburring tool DIN 335	051211	324
DIN 335 A, HSS	050810	325
WN 181, HSS	051010	326

Countersinks 60°

DIN 334 C, HSS	051110	327
DIN 334 C, HSS, TiN coated	053320	328
DIN 334 D, HSS	051111	329
DIN 334 A, HSS	050610	330
WN 180, HSS	051010	331



REVOLUTION IN COUNTERSINKING

EUC-Speed – finally quiet, fast and precise

Every machining process has latent potential for boosting productivity. There is significant potential for improvement even in seemingly secondary machining operations. This issue is demonstrated by the new generation of countersinks.

The newly developed EUC-Speed operates with significantly reduced axial forces. The cutting edges on the countersinks have an unequal spacing. With this spacing, the axial forces are reduced by more than 50 % and the radial forces by 25 % compared with conventional coun-

tersinks. Such optimised operating conditions create far less vibrations at the tool, allowing higher accuracies and better surface finishes to be achieved. The precision of the countersink leads to an immediately improved contact of the joint under load after assembly. The reduced load on the machine also increases the life of the tools. Thanks to the smooth and stable running, the tools can also be operated with higher cutting data. The result is significant time savings.



Tool features EUC-Speed in detail

Radial force reduced by 25 %

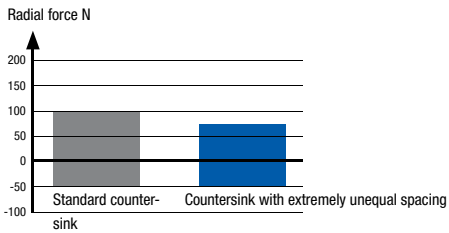

Axial force reduced by 50 %

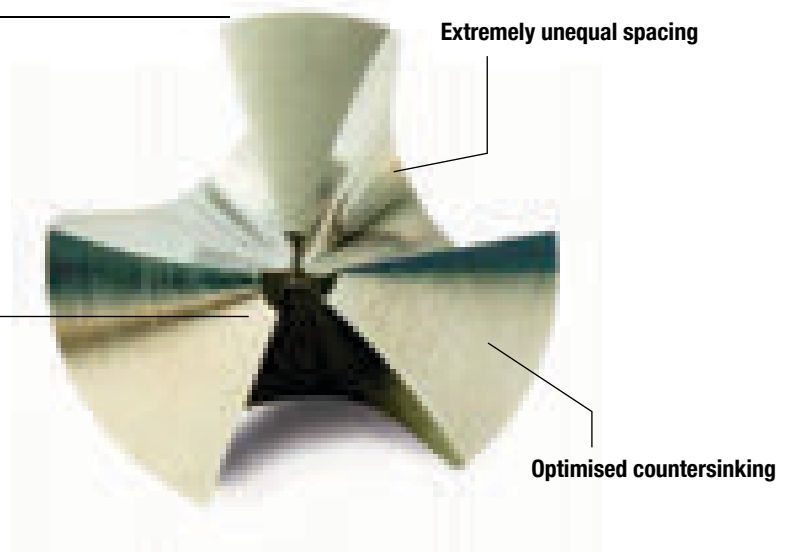
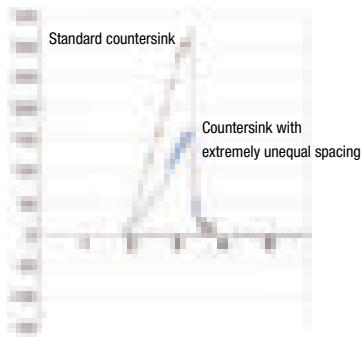

Countersink with extremely unequal spacing



Standard countersink

HSS and solid carbide design, coated

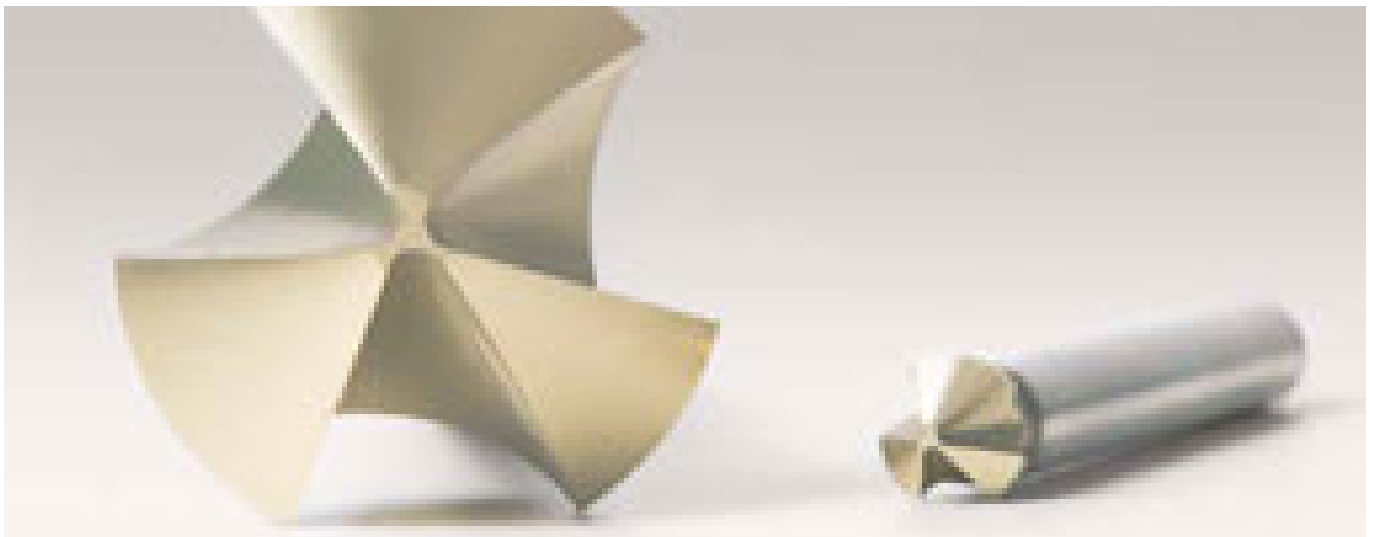

HSS design, coated

The three cutting edges on the countersinks from BECK made of HSS with high-performance coating have extremely unequal spacing. As a consequence the axial forces are reduced and significantly less vibration is generated on the tool. In this way higher accuracies and better surface finishes are achieved. The precision of the countersink leads to the directly improved contact of bolted and riveted joints.

Solid carbide design, coated

In addition to the high-performance coated HSS designs of countersinks, BECK also offers selected diameters as a coated solid carbide version. Along with the advantages of the unequal spacing, the solid carbide design offers additional advantages during the machining of demanding workpiece materials such as titanium, high-alloy cast iron, Inconel or CFRP. Longer tool lives and cutting speeds compared to the coated HSS design are reliably achieved.

EUC-Speed I 044210

Precision design, extreme unequal spacing

Design:

Diameter:
Cutting direction:
Cutting material:

6,30-31,00 mm
Right-hand cutting
Solid carbide,
special coating

Special feature:

Radially relieved

Shank tolerance h6
(suitable for hydraulic chucks and shrink chucks)

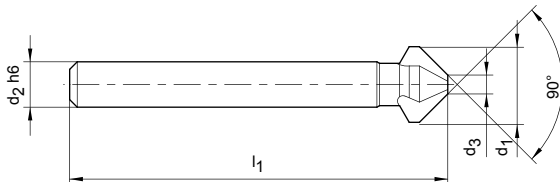

Dimensions				z	Order No.
d ₁	d ₂ h6	d ₃	l ₁		
6,30	5	1,5	45	3	30729770
8,30	6	2,0	50	3	30729772
10,40	6	2,5	50	3	30729774
12,40	8	2,8	56	3	30729776
16,50	10	3,2	60	3	30729778
20,50	10	3,5	63	3	30729780
25,00	10	3,8	67	3	30729782
31,00	12	4,2	71	3	30729783

EUC-Speed I 054210

Precision design, extreme unequal spacing

Design:

Diameter: 4,30-31,00 mm
Cutting direction: Right-hand cutting
Cutting material: HSS, special coating

Special feature:

Radially relieved

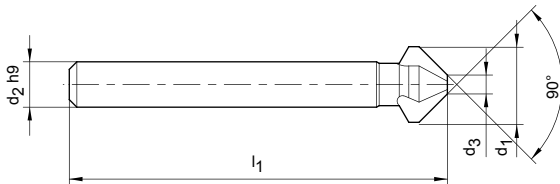

Dimensions				z	Order No.
d ₁	d ₂ h9	d ₃	l ₁		
4,30	4	1,3	40	3	30662977
6,00	5	1,5	45	3	30662978
6,30	5	1,5	45	3	30602669
8,00	6	2,0	50	3	30662979
8,30	6	2,0	50	3	30662980
10,00	6	2,5	50	3	30662982
10,40	6	2,5	50	3	30602672
11,50	8	2,8	56	3	30662984
12,40	8	2,8	56	3	30662985
15,00	10	3,2	60	3	30662986
16,50	10	3,2	60	3	30602673
19,00	10	3,5	63	3	30662987
20,50	10	3,5	63	3	30602674
23,00	10	3,8	67	3	30662988
25,00	10	3,8	67	3	30602675
31,00	12	4,2	71	3	30662989

Countersink-Set, EUC-Speed 054218, HSS design

Set	Diameter	EUC-Speed, HSS 054210 Order No.
5 pieces	6.30 / 10.40 / 16.50 / 20.50 / 25.00	30602967



Dimensions in mm.

Cutting data see page 367 ff.

Countersink 90° I 041020

Precision design

Design:

Diameter:

6,30-31,00 mm

Cutting direction:

Right-hand cutting

Cutting material:

Solid carbide, uncoated

Special feature:

Radially relieved

Shank tolerance h6
(suitable for hydraulic
chucks and shrink
chucks)

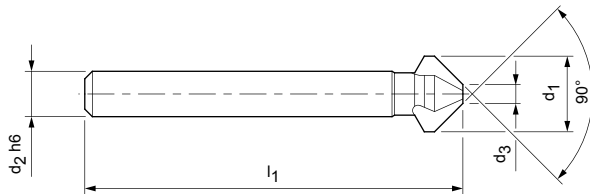

Dimensions				z	Order No.
d ₁	d ₂ h6	d ₃	l ₁		
6,30	5	1,5	45	3	30110278
8,30	6	2	50	3	30110280
10,40	6	2,5	50	3	30110282
12,40	8	2,8	56	3	30110284
16,50	10	3,2	60	3	30110286
20,50	10	3,5	63	3	30110288
25,00	10	3,8	67	3	30110290
31,00	12	4,2	71	3	30110292

Countersink 90° | 051210

Precision design

Design:

Diameter: 4,30-31,00 mm
 Cutting direction: Right-hand cutting
 Cutting material: HSS, uncoated

Special feature:

Radially relieved

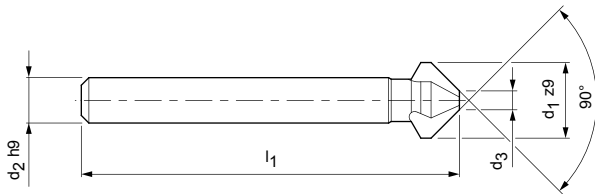

Dimensions				z	Order No.
d ₁ z ₉	d ₂ h ₉	d ₃	l ₁		
4,30	4	1,3	40	3	30111110
4,80	4	1,5	40	3	30111112
5,00	4	1,5	40	3	30111114
5,30	4	1,5	40	3	30111116
5,80	5	1,5	45	3	30111118
6,00	5	1,5	45	3	30111120
6,30	5	1,5	45	3	30111122
7,00	6	1,8	50	3	30111124
7,30	6	1,8	50	3	30111126
8,00	6	2	50	3	30111128
8,30	6	2	50	3	30111130
9,40	6	2,2	50	3	30111132
10,00	6	2,5	50	3	30111134
10,40	6	2,5	50	3	30111136
11,50	8	2,8	56	3	30111138
12,40	8	2,8	56	3	30111140
13,40	8	2,9	56	3	30111142
14,40	8	3	56	3	30111144
15,00	10	3,2	60	3	30111146
16,50	10	3,2	60	3	30111148
19,00	10	3,5	63	3	30111150
20,50	10	3,5	63	3	30111152
23,00	10	3,8	67	3	30111154
25,00	10	3,8	67	3	30111156
26,00	10	3,8	67	3	30111158
28,00	12	4	71	3	30111160
30,00	12	4,2	71	3	30111162
31,00	12	4,2	71	3	30111164

Countersink-Set, 90°, 051218, precision design, uncoated

Set	Diameter	Order No.
5 pieces	6.30/10.40/16.50/20.50/25.00	30111176

Dimensions in mm.
 Cutting data see page 367 ff.

Countersink 90° | 053212

Precision design

Design:

Diameter:

6,30-31,00 mm

Cutting direction:

Right-hand cutting

Cutting material:

HSS, TiAlN coated

Special feature:

Radially relieved

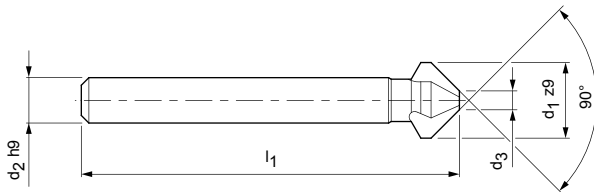

Dimensions				z	Order No.
d ₁ z9	d ₂ h9	d ₃	l ₁		
6,30	5	1,5	45	3	30117700
8,30	6	2	50	3	30117702
10,40	6	2,5	50	3	30117704
12,40	8	2,8	56	3	30117706
15,00	10	3,2	60	3	30117709
16,50	10	3,2	60	3	30117711
20,50	10	3,5	63	3	30117713
25,00	10	3,8	67	3	30117715
31,00	12	4,2	71	3	30117717

Dimensions in mm.

Cutting data see page 367 ff.

Countersink 90° | 053210

Precision design

Design:

Diameter: 4,80-31,00 mm
 Cutting direction: Right-hand cutting
 Cutting material: HSS, TiN coated

Special feature: Radially relieved

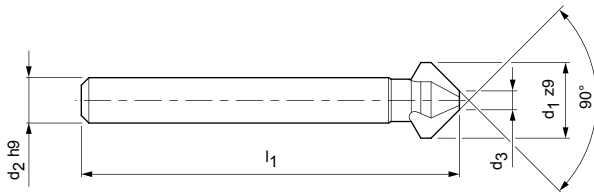

Dimensions				z	Order No.
d ₁ z ₉	d ₂ h ₉	d ₃	l ₁		
4,80	4	1,5	40	3	30117658
5,00	4	1,5	40	3	30117660
6,00	5	1,5	45	3	30117662
6,30	5	1,5	45	3	30117664
7,00	6	1,8	50	3	30117666
7,30	6	1,8	50	3	30117668
8,00	6	2	50	3	30117670
8,30	6	2	50	3	30117672
9,40	6	2,2	50	3	30117674
10,00	6	2,5	50	3	30117676
10,40	6	2,5	50	3	30117678
11,50	8	2,8	56	3	30117680
12,40	8	2,8	56	3	30117682
15,00	10	3,2	60	3	30117684
16,50	10	3,2	60	3	30117686
19,00	10	3,5	63	3	30117688
20,50	10	3,5	63	3	30117690
23,00	10	3,8	67	3	30117692
25,00	10	3,8	67	3	30117694
31,00	12	4,2	71	3	30117696

Countersink-Set, 90°, 053220, precision design, TiN coated

Set	Diameter	Order No.
5 pieces	6.30/10.40/16.50/20.50/25.00	30359531

Dimensions in mm.
 Cutting data see page 367 ff.

Countersink 90° | 051207

Precision design, shank with three clamping surfaces

Design:

Diameter:

11,50-31,00 mm

Cutting direction:

Right-hand cutting

Cutting material:

HSS, uncoated

Special feature:

Radially relieved

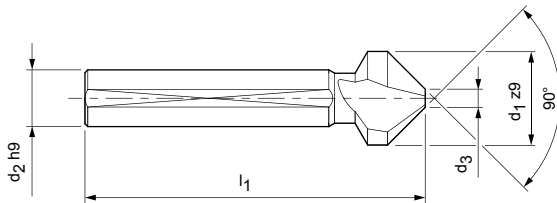

Dimensions				z	Order No.
d ₁ z ₉	d ₂ h ₉	d ₃	l ₁		
11,50	8	2,8	56	3	30111000
12,40	8	2,8	56	3	30111002
13,40	8	2,9	56	3	30111004
15,00	10	3,2	60	3	30111006
16,50	10	3,2	60	3	30111008
19,00	10	3,5	63	3	30111010
20,50	10	3,5	63	3	30111012
23,00	10	3,8	67	3	30111014
25,00	10	3,8	67	3	30111016
26,00	10	3,8	67	3	30111018
28,00	12	4	71	3	30111020
30,00	12	4,2	71	3	30111022
31,00	12	4,2	71	3	30111024

Countersink 90° | 053207

Precision design, shank with three clamping surfaces

Design:

Diameter:

11,50-31,00 mm

Cutting direction:

Right-hand cutting

Cutting material:

HSS, TiN coated

Special feature:

Radially relieved

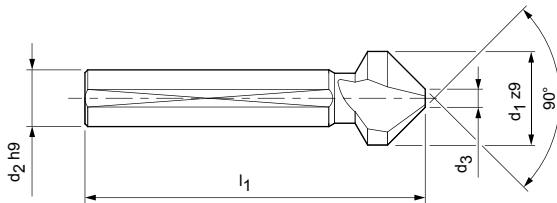

Dimensions				z	Order No.
d ₁ z9	d ₂ h9	d ₃	l ₁		
11,50	8	2,8	56	3	30117648
12,40	8	2,8	56	3	30117649
13,40	8	2,9	56	3	30117650
15,00	10	3,2	60	3	30117651
16,50	10	3,2	60	3	30117652
19,00	10	3,5	63	3	30117653
20,50	10	3,5	63	3	30117654
23,00	10	3,8	67	3	30117655
25,00	10	3,8	67	3	30117656
31,00	12	4,2	71	3	30136388

Dimensions in mm.

Cutting data see page 367 ff.

Countersink 90° | 051310

Precision design, Morse taper shank

Design:

Diameter:

15,00-100,00 mm

Cutting direction:

Right-hand cutting

Cutting material:

HSS, uncoated

Special feature:

Radially relieved

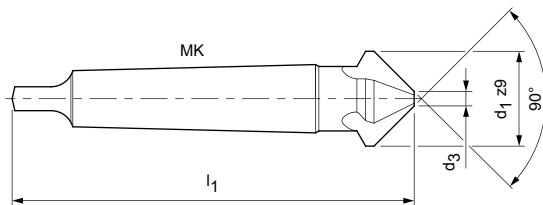

Dimensions				z	Order No.
d ₁ z ₉	d ₃	l ₁	MK		
15,00	3,2	85	1	3	30111220
16,50	3,2	85	1	3	30111222
19,00	3,5	100	2	3	30111224
20,50	3,5	100	2	3	30111226
23,00	3,8	106	2	3	30111228
25,00	3,8	106	2	3	30111230
26,00	3,8	106	2	3	30111232
28,00	4	112	2	3	30111234
30,00	4,2	112	2	3	30111236
31,00	4,2	112	2	3	30111238
34,00	4,5	118	2	3	30111240
37,00	4,8	118	2	3	30111242
40,00	10	140	3	3	30111244
50,00	14	150	3	3	30111246
63,00	16	180	4	3	30111248
80,00	22	190	4	3	30111250
100,00	28	200	4	3	30111252

Countersink 90° | 053310

Precision design, Morse taper shank

Design:

Diameter: 25,00-63,00 mm
 Cutting direction: Right-hand cutting
 Cutting material: HSS, TiN coated

Special feature: Radially relieved

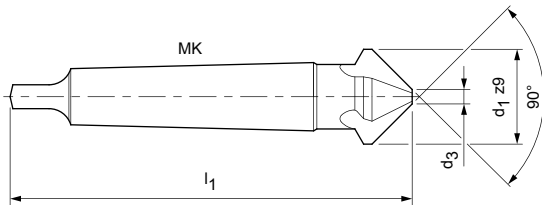

Dimensions				z	Order No.
d ₁ z ₉	d ₃	l ₁	MK		
25,00	3,8	106	2	3	30117720
31,00	4,2	112	2	3	30117722
37,00	4,8	118	2	3	30117724
40,00	10	140	3	3	30117726
50,00	14	150	3	3	30117728
63,00	16	180	4	3	30117730

Hand deburring tool 90° | 051211

Precision design, with plastic handle

Note: Production has been finished. Delivery only as long as stock lasts.

Design:

Diameter:

12,40-25,00 mm

Cutting direction:

Right-hand cutting

Cutting material:

HSS, uncoated

Special feature:

Radially relieved

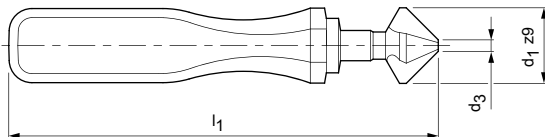

Dimensions			z	Order No.
d ₁ z9	d ₃	l ₁		
12,40	2,8	133	3	30111167
16,50	3,2	135	3	30111169
20,50	3,5	138	3	30111171
25,00	3,8	142	3	30111173

Countersink 90° | 050810

Multi-fluted countersink for machining high-strength materials

Design:

Diameter:

Cutting direction:

Cutting material:

8,00-20,00 mm

Right-hand cutting

HSS, uncoated

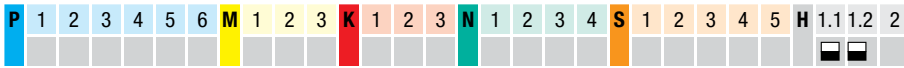
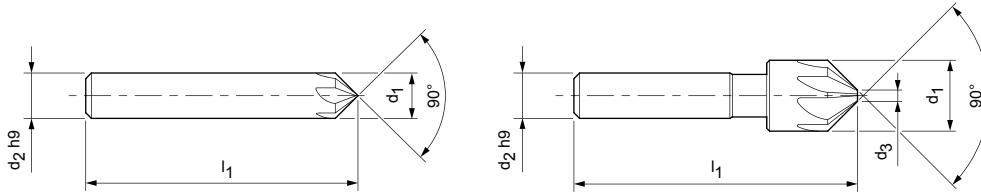

Dimensions				z	Order No.
d ₁	d ₂ h9	d ₃	l ₁		
8,00	8		48	5	30110910
12,50	8	2	48	5	30110912
16,00	10	3,2	56	7	30110914
20,00	10	5	60	7	30110916

Countersink WN 181, 90° I 051011

Single-edged design

Design:

Diameter:

Cutting direction:

Cutting material:

6,00-31,50 mm

Right-hand cutting

HSS, uncoated

Special feature:

Radially relieved sharp point

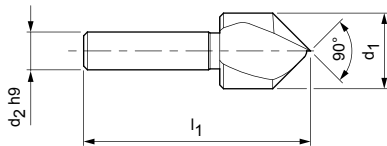

Dimensions			Order No.
d_1	d_2 h9	l_1	
6,00	6	45	30110944
8,00	8	50	30110946
10,00	8	49	30110948
12,50	8	49	30110950
16,00	10	56	30110952
20,00	10	60	30110954
25,00	12	75	30110956
31,50	12	80	30110958

Countersink 60° | 051110

Precision design

Design:

Diameter:

6,30-25,00 mm

Cutting direction:

Right-hand cutting

Cutting material:

HSS, uncoated

Special feature:

Radially relieved

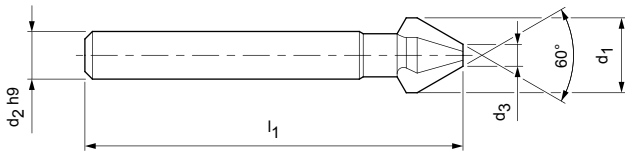

Dimensions				z	Order No.
d ₁	d ₂ h9	d ₃	l ₁		
6,30	5	1,6	45	3	30110968
8,00	6	2	50	3	30110970
10,00	6	2,5	50	3	30110972
12,50	8	3,2	56	3	30110974
16,00	10	4	63	3	30110976
20,00	10	5	67	3	30110978
22,50	10	5,6	71	3	30110980
25,00	10	6,3	71	3	30110982

Dimensions in mm.

Cutting data see page 367 ff.

Countersink 60° | 053320

Precision design

Design:

Diameter:

6,30-25,00 mm

Cutting direction:

Right-hand cutting

Cutting material:

HSS, TiN coated

Special feature:

Radially relieved

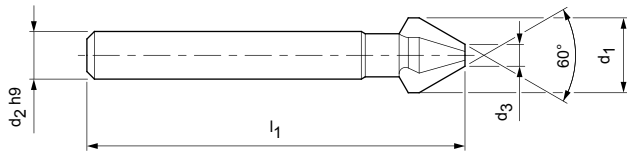

Dimensions				z	Order No.
d ₁	d ₂ h9	d ₃	l ₁		
6,30	5	1,6	45	3	30117732
8,00	6	2	50	3	30117734
10,00	6	2,5	50	3	30117736
12,50	8	3,2	56	3	30117738
16,00	10	4	63	3	30117740
20,00	10	5	67	3	30117742
22,50	10	5,6	71	3	30117744
25,00	10	6,3	71	3	30117746

Dimensions in mm.

Cutting data see page 367 ff.

Countersink 60° | 051111

Precision design with Morse taper shank

Design:

Diameter: 16,00-80,00 mm
Cutting direction: Right-hand cutting
Cutting material: HSS, uncoated

Special feature:

Radially relieved

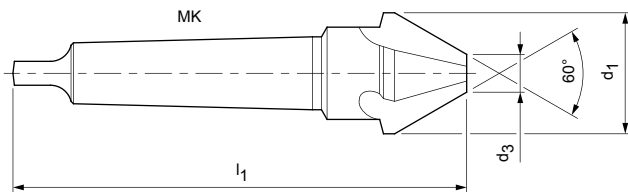

Dimensions				z	Order No.
d ₁	d ₃	l ₁	MK		
16,00	4	90	1	3	30110984
20,00	5	106	2	3	30110986
25,00	6,3	112	2	3	30110988
31,50	10	118	2	3	30110990
40,00	12,5	150	3	3	30110992
50,00	16	160	3	3	30110994
63,00	20	190	4	3	30110996
80,00	25	200	4	3	30110998

Dimensions in mm.

Cutting data see page 367 ff.

Countersink 60° | 050610

Multi-fluted countersink for machining high-strength materials

Design:

Diameter:

Cutting direction:

Cutting material:

8,00-20,00 mm

Right-hand cutting

HSS, uncoated

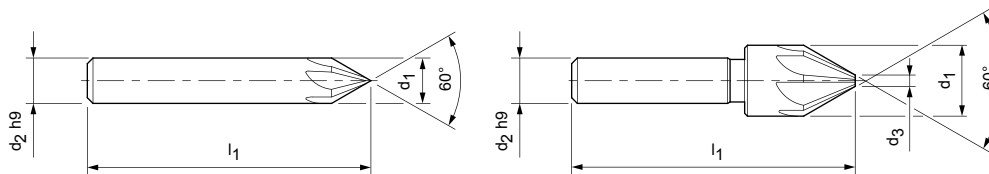

Dimensions				z	Order No.
d ₁	d ₂ h9	d ₃	l ₁		
8,00	8		50	5	30110881
12,50	8	2	50	5	30110883
16,00	10	3,2	60	7	30110885
20,00	10	5	63	7	30110887

Countersink WN 180, 60° I 051010

Single-edged design

Design:

Diameter:

6,00-31,50 mm

Cutting direction:

Right-hand cutting

Cutting material:

HSS, uncoated

Special feature:

Radially relieved sharp point

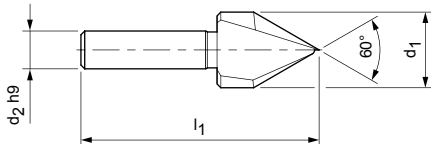

Dimensions				Order No.
d_1	d_2 h9	l_1		
6,00	6	45		30135229
8,00	8	50		30110930
10,00	8	52		30110932
12,50	8	52		30110934
16,00	10	60		30110936
20,00	10	63		30110938
25,00	12	82		30110940
31,50	12	90		30110942

Dimensions in mm.

Cutting data see page 367 ff.





COUNTERBORES

Counterbores for through bores

DIN 373, fine, HSS, uncoated	051510	334
Set DIN 373, fine, HSS, uncoated	051513	334
DIN 373, fine, HSS, TiN coated	053510	335
DIN 373, medium, HSS, uncoated	051511	336
Set DIN 373, medium, HSS, uncoated	051514	336
DIN 373, medium, HSS, TiN coated	053511	337
WN 178, fine, HSS, uncoated	051710	339
WN 178, medium, HSS, uncoated	051711	340

Counterbore for tapping bore

DIN 373, HSS, uncoated	051512	338
Set DIN 373, HSS, uncoated	051515	338

Counterbore for interchangeable pilots

DIN 375, HSS, uncoated	051610	341
Pilots DIN 1868	051611	342

Counterbore I 051510

For fine through bore

Design:

Diameter:

Cutting direction:

Cutting material:

6,00-20,00 mm

Right-hand cutting

HSS, uncoated

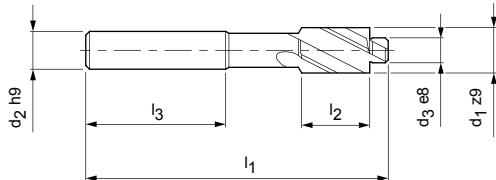

Dimensions							z	Order No.
d ₁ z9	d ₂ h9	d ₃ e8	Thread	l ₁	l ₂	l ₃		
6,00	5	3,2	M3	71	14	31,5	3	30165316
6,50	5	3,2	M3	71	14	31,5	3	30111323
6,50	5	3,7	M3,5	71	14	31,5	3	30111325
8,00	5	4,3	M4	71	14	31,5	3	30111327
10,00	8	5,3	M5	80	18	35,5	3	30111329
11,00	8	6,4	M6	80	18	35,5	3	30111331
15,00	12,5	8,4	M8	100	22	40	3	30111333
18,00	12,5	10,5	M10	100	22	40	3	30111335
20,00	12,5	13	M12	100	22	40	3	30111337

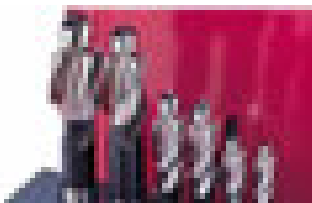
**Counterbore-Set for fine through bore
051513, with metal cassette, uncoated**

Set	Thread	Order No.
6- pieces	M3, M4, M5, M6, M8, M10	30111371

Counterbore I 053510

For fine through bore

Design:

Diameter:

6,00-20,00 mm

Cutting direction:

Right-hand cutting

Cutting material:

HSS, TiN coated

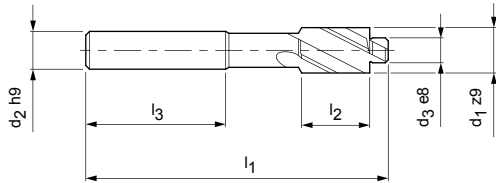

Dimensions							z	Order No.
d ₁ z9	d ₂ h9	d ₃ e8	Thread	l ₁	l ₂	l ₃		
6,00	5	3,2	M3	71	14	31,5	3	30117754
6,50	5	3,2	M3	71	14	31,5	3	30117755
8,00	5	4,3	M4	71	14	31,5	3	30117756
10,00	8	5,3	M5	80	18	35,5	3	30117757
11,00	8	6,4	M6	80	18	35,5	3	30117758
15,00	12,5	8,4	M8	100	22	40	3	30117759
18,00	12,5	10,5	M10	100	22	40	3	30117760
20,00	12,5	13	M12	100	22	40	3	30117761

Counterbore I 051511

For medium through bore

Design:

Diameter:

Cutting direction:

Cutting material:

6,00-20,00 mm

Right-hand cutting

HSS, uncoated

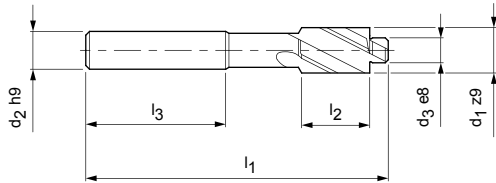

Dimensions							z	Order No.
d ₁ z9	d ₂ h9	d ₃ e8	Thread	l ₁	l ₂	l ₃		
6,00	5	3,4	M3	71	14	31,5	3	30165317
6,50	5	3,4	M3	71	14	31,5	3	30111339
6,50	5	3,9	M3,5	71	14	31,5	3	30111341
8,00	5	4,5	M4	71	14	31,5	3	30111343
10,00	8	5,5	M5	80	18	35,5	3	30111345
11,00	8	6,6	M6	80	18	35,5	3	30111347
15,00	12,5	9	M8	100	22	40	3	30111349
18,00	12,5	11	M10	100	22	40	3	30111351
20,00	12,5	13,5	M12	100	22	40	3	30111353

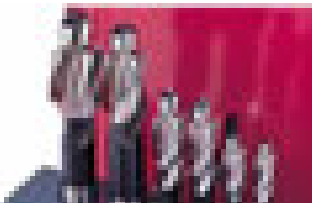

Counterbore-Set for medium through bore 051514, with metal cassette, uncoated

Set	Thread	Order No.
6 pieces	M3, M4, M5, M6, M8, M10	30111372

Counterbore I 053511

For medium through bore

Design:

Diameter:

6,00-20,00 mm

Cutting direction:

Right-hand cutting

Cutting material:

HSS, TiN coated

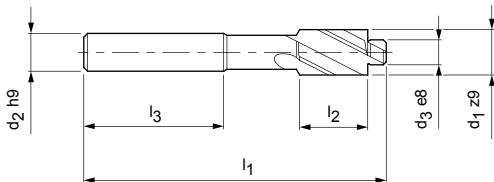

Dimensions							z	Order No.
$d_1 z9$	$d_2 h9$	$d_3 e8$	Thread	l_1	l_2	l_3		
6,00	5	3,4	M3	71	14	31,5	3	30117762
6,50	5	3,4	M3	71	14	31,5	3	30117763
8,00	5	4,5	M4	71	14	31,5	3	30117764
10,00	8	5,5	M5	80	18	35,5	3	30117765
11,00	8	6,6	M6	80	18	35,5	3	30117766
15,00	12,5	9	M8	100	22	40	3	30117767
18,00	12,5	11	M10	100	22	40	3	30117768
20,00	12,5	13,5	M12	100	22	40	3	30117769

Counterbore I 051512

For tapping bore

Design:

Diameter:

Cutting direction:

Cutting material:

6,00-20,00 mm

Right-hand cutting

HSS, uncoated

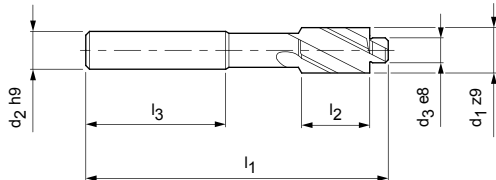

Dimensions							z	Order No.
d ₁ z ₉	d ₂ h ₉	d ₃ e ₈	Thread	l ₁	l ₂	l ₃		
6,00	5	2,5	M3	71	14	31,5	3	30165315
6,50	5	2,5	M3	71	14	31,5	3	30111355
6,50	5	2,9	M3,5	71	14	31,5	3	30111357
8,00	5	3,3	M4	71	14	31,5	3	30111359
10,00	8	4,2	M5	80	18	35,5	3	30111361
11,00	8	5	M6	80	18	35,5	3	30111363
15,00	12,5	6,8	M8	100	22	40	3	30111365
18,00	12,5	8,5	M10	100	22	40	3	30111367
20,00	12,5	10,2	M12	100	22	40	3	30111369

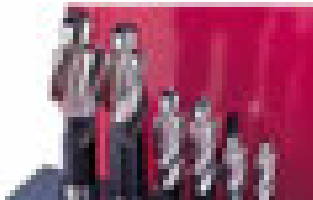

**Counterbore-Set for tapping bore
051515, with metal cassette, uncoated**

Set	Thread	Order No.
6 pieces	M3, M4, M5, M6, M8, M10	30359523

Counterbore WN 178 I 051710

With Morse taper shank, for fine through bore

Design:

Diameter:

18,00-40,00 mm

Cutting direction:

Right-hand cutting

Cutting material:

HSS, uncoated

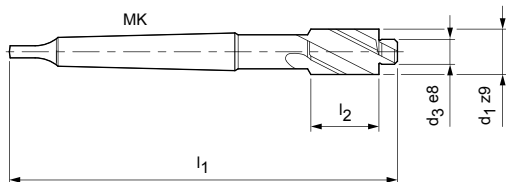

Dimensions						z	Order No.
d ₁ z ₉	d ₃ e ₈	Thread	l ₁	l ₂	MK		
18,00	10,5	M10	150	25	2	3	30111529
20,00	13	M12	150	25	2	3	30111531
24,00	15	M14	162	30	2	3	30111533
26,00	17	M16	192	35	3	3	30111535
30,00	19	M18	192	35	3	3	30111537
33,00	21	M20	204	40	3	3	30111539
36,00	23	M22	204	40	3	3	30111541
40,00	25	M24	204	40	3	3	30111543

Counterbore WN 178 I 051711

With Morse taper shank, for medium through bore

Design:

Diameter:

Cutting direction:

Cutting material:

18,00-40,00 mm

Right-hand cutting

HSS, uncoated

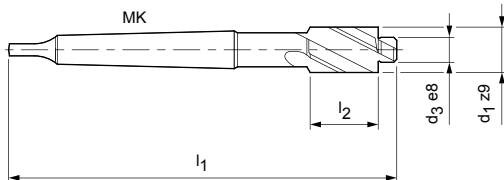

Dimensions						z	Order No.
d ₁ z ₉	d ₃ e ₈	Thread	l ₁	l ₂	MK		
18,00	11	M10	150	25	2	3	30111545
20,00	13,5	M12	150	25	2	3	30111547
24,00	15,5	M14	162	30	2	3	30111549
26,00	17,5	M16	192	35	3	3	30111551
30,00	20	M18	192	35	3	3	30111553
33,00	22	M20	204	40	3	3	30111555
36,00	24	M22	204	40	3	3	30111557
40,00	26	M24	204	40	3	3	30111559

Counterbore I 051610

With Morse taper shank, for interchangeable pilots DIN 1868

Design:

Diameter:

15,00-63,00 mm

Cutting direction:

Right-hand cutting

Cutting material:

HSS, uncoated

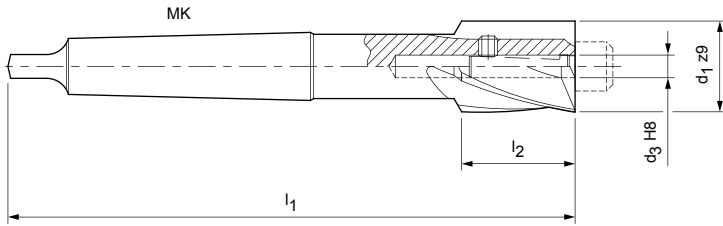

Dimensions					z	Order No.
d ₁ z9	d ₃ H8	l ₁	l ₂	MK		
15,00	4	132	22	2	3	30111374
18,00	5	140	25	2	3	30111376
20,00	5	140	25	2	3	30111378
24,00	6	150	30	2	3	30111380
26,00	8	180	35	3	3	30111382
30,00	8	180	35	3	3	30111384
33,00	10	190	40	3	3	30111386
36,00	10	190	40	3	3	30111388
40,00	10	190	40	3	3	30111390
43,00	12	236	50	4	4	30111392
46,00	12	236	50	4	4	30111394
50,00	12	236	50	4	4	30111397
54,00	16	250	63	4	4	30111399
58,00	16	250	63	4	4	30111401
61,00	16	250	63	4	4	30111403
63,00	16	250	63	4	4	30111405

Pilots I 051611

For counterbores DIN 375, for fine through bore

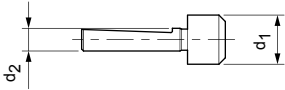

DIN
1868

Dimensions			For counterbore \emptyset	Order No.
d_1	d_2 f7	Thread		
8,40	4	M 8	15	30111409
8,40	5	M 8	18 / 20	30111424
10,50	5	M 10	18 / 20	30111414
10,50	6	M 10	24	30111432
13,00	5	M 12	20	30111418
13,00	6	M 12	24	30111438
13,00	8	M 12	26	30111452
15,00	6	M 14	24	30111442
15,00	8	M 14	26 / 30	30111458
17,00	8	M 16	26 / 30	30111462
17,00	10	M 16	33	30111474
19,00	8	M 18	30	30111466
19,00	10	M 18	33 / 36	30111478
21,00	10	M 20	33 / 36 / 40	30111484
23,00	10	M 22	36 / 40	30111488
23,00	12	M 22	43	30111500
25,00	10	M 24	40	30111492
25,00	12	M 24	43 / 46	30111504

Pilots I 051611

For counterbores DIN 375, for medium through bore

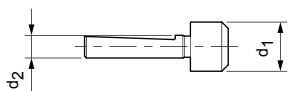

DIN
1868

Dimensions			For counterbore \emptyset	Order No.
d_1	d_2 f7	Thread		
9,00	4	M 8	15	30111411
9,00	5	M 8	18 / 20	30111428
11,00	5	M 10	18 / 20	30111416
11,00	6	M 10	24	30111434
13,50	5	M 12	20	30111420
13,50	6	M 12	24	30111440
13,50	8	M 12	26	30111454
15,50	6	M 14	24	30111444
15,50	8	M 14	26 / 30	30111460
17,50	8	M 16	26 / 30	30111464
17,50	10	M 16	33	30111476
20,00	8	M 18	30	30111468
20,00	10	M 18	33 / 36	30111482
22,00	10	M 20	33 / 36 / 40	30111486
24,00	10	M 22	36 / 40	30111490
24,00	12	M 22	43	30111502
26,00	10	M 24	40	30111494
26,00	12	M 24	43 / 46	30111505
30,00	12	M 27	43 / 46	30111509
30,00	16	M 27	54	30111519
33,00	12	M 30	50	30111511
33,00	16	M 30	54 / 61	30111523
36,00	16	M 33	54 / 58 / 63	30111525
39,00	16	M 36	58 / 61	30111527

Pilots I 051611

For counterbores DIN 375, for tapping bores

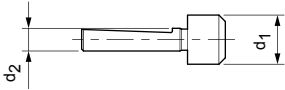

DIN
1868

Dimensions			For counterbore \emptyset	Order No.
d_1	d_2 f7	Thread		
6,80	4	M 8	15	30111407
6,80	5	M 8	18 / 20	30111422
8,50	5	M 10	18 / 20	30111426
8,50	6	M 10	24	30111446
10,20	5	M 12	20	30111412
10,20	6	M 12	24	30111430
10,20	8	M 12	26	30111448
12,00	6	M 14	24	30111436
12,00	8	M 14	26 / 30	30111450
14,00	8	M 16	26 / 30	30111456
14,00	10	M 16	33	30111470
15,50	8	M 18	30	30111460
15,50	10	M 18	33 / 36	30111472
17,50	10	M 20	33 / 36 / 40	30111476
19,50	10	M 22	36 / 40	30111480
19,50	12	M 22	43	30111496
21,00	10	M 24	40	30111484
21,00	12	M 24	43 / 46	30111498
24,00	12	M 27	43 / 46	30111502
24,00	16	M 27	54	30111513
26,50	12	M 30	50	30111507
26,50	16	M 30	54 / 61	30111515
29,50	16	M 33	54 / 58 / 63	30111517
32,00	16	M 36	58 / 61	30111521





CORE DRILLS

Introduction

Product overview	348
------------------------	-----

Core drills with cylindrical shank

DIN 344, full size, HSS	050010	350
DIN 344, under size, HSS	050011	351
Overview configurable series		352

Core drills with Morse taper shank

DIN 343, full size, HSS	050110	353
DIN 343, under size, HSS	050111	355
Overview configurable series		357

Shell core drills

DIN 222, full size, HSS	050310	359
DIN 222, under size, HSS	050311	361
Overview configurable series		363
Holder for shell core drills	031610	365

PRODUCT OVERVIEW

Boring tools made of HSS

HSS boring tools are used to create the necessary initial size of a bore for the subsequent reaming. They are characterised by their simple handling. More important, however, is the matching of the diameter to the reaming operation. This eliminates the need for expensive drilling tools with intermediate diameters. Longer tool lives are achieved due to the chip space ground design.



Core drills with cylindrical shank in accordance with DIN 344



Full size and under size

Ø range: 4.8 – 20.0 mm

Basic
LINE

Page 350

Core drills with Morse taper shank in accordance with DIN 343



Full size and under size

Ø range: 7.8 – 50.0 mm

Basic
LINE

Page 353



Shell core drills in accordance DIN 222



Full size and under size

Ø range: 23.7 – 100.0 mm

Basic
LINE

Core drill - full size I 050010

Preferred series with cylindrical shank and driving tang in accordance to DIN 1809

Design:

Diameter:

Cutting direction:

Cutting material:

Flute direction:

5,00-20,00 mm

Right-hand cutting

HSS

Approx. 27°

right-hand spiral

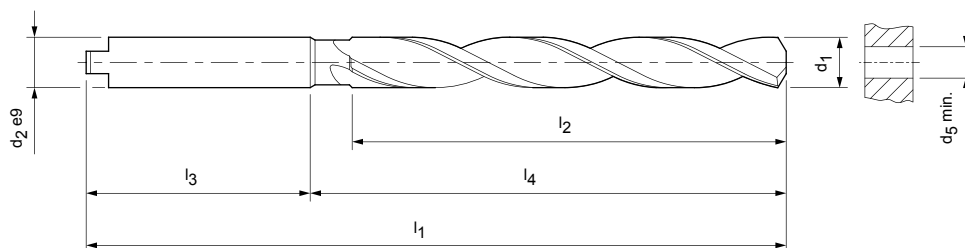

Dimensions							z	Order No.
d ₁ h8	d ₂ e9	l ₁	l ₂	l ₃	l ₄	d ₅ min		
5,00	5	108	65	32	76	3,5	3	30110316
6,00	6	116	71	34	82	4,2	3	30110318
7,00	7	133	84	39	94	4,9	3	30110320
8,00	8	142	91	41	101	5,6	3	30110322
9,00	9	151	98	43	108	6,3	3	30110324
10,00	10	162	107	45	117	7,0	3	30110326
11,00	11	173	114	45	128	7,7	3	30110328
12,00	12	184	123	47	137	8,4	3	30110330
13,00	13	184	123	47	137	9,1	3	30110332
14,00	14	194	132	47	147	9,8	3	30110334
15,00	15	202	137	50	152	10,5	3	30110336
16,00	16	211	143	53	158	11,2	3	30110338
17,00	17	218	146	52	166	11,9	3	30110340
18,00	18	226	152	56	170	12,6	3	30110342
19,00	19	234	158	58	176	13,3	3	30110344
20,00	20	242	164	60	182	14,0	3	30110346

Dimensions in mm.

Intermediate diameters and special tolerances can be ordered by the overview pages for configurable series on page 352.

Core drill - under size I 050011

Preferred series with cylindrical shank and driving tang in accordance to DIN 1809

Design:

Diameter:
Cutting direction:
Beschichtung:
Flute direction:

4,80-19,70 mm
Right-hand cutting
HSS
Approx. 27°
right-hand spiral

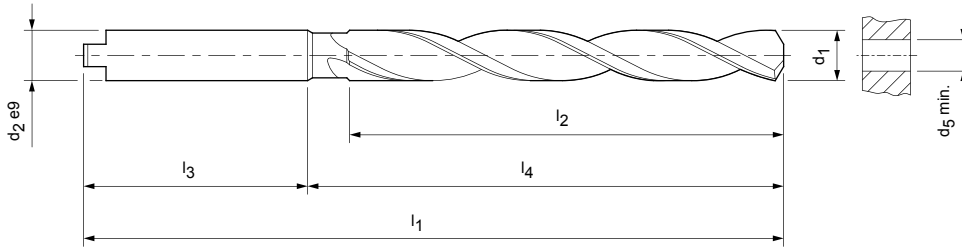

Dimensions							z	Order No.
d ₁ h8	d ₂ e9	l ₁	l ₂	l ₃	l ₄	d ₅ min		
4,80	5	108	65	32	76	3,5	3	30110348
5,80	6	116	71	34	82	4,2	3	30110350
6,80	7	133	84	39	94	4,9	3	30110352
7,80	8	142	91	41	101	5,6	3	30110354
8,80	9	151	98	43	108	6,3	3	30110356
9,80	10	162	107	45	117	7,0	3	30110358
10,75	11	173	114	45	128	7,7	3	30110360
11,75	12	184	123	47	137	8,4	3	30110362
12,75	13	184	123	47	137	9,1	3	30110364
13,75	14	194	132	47	147	9,8	3	30110366
14,75	15	202	137	50	152	10,5	3	30110369
15,75	16	211	143	53	158	11,2	3	30110371
16,75	17	218	146	52	166	11,9	3	30110373
17,75	18	226	152	56	170	12,6	3	30110375
18,70	19	234	158	58	176	13,3	3	30110377
19,70	20	242	164	60	182	14,0	3	30110379

Core drill overview | 050010

Configurable series with cylindrical shank and driving tang in accordance to DIN 1809

Design:

Diameter: 4,700-20,200 mm
 Cutting direction: Right-hand cutting
 Cutting material: HSS
 Flute direction: Approx. 27° right-hand spiral

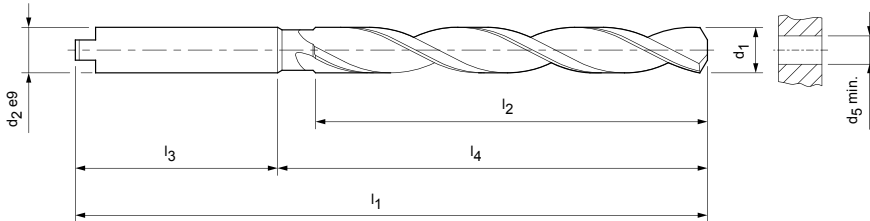

Dimensions							z
d ₁	d ₂ e9	l ₁	l ₂	l ₃	l ₄	d ₅ min	
4,700-5,200	5	108	65	32	76	3,5	3
5,201-5,700	5,5	116	71	34	82	4,2	3
5,701-6,200	6	116	71	34	82	4,2	3
6,201-6,700	6,5	124	77	36	93	4,2	3
6,701-7,200	7	133	84	39	94	4,9	3
7,201-7,700	7,5	133	84	39	94	4,9	3
7,701-8,200	8	142	91	41	101	5,6	3
8,201-8,700	8,5	142	91	41	101	5,6	3
8,701-9,200	9	151	98	43	108	6,3	3
9,201-9,700	9,5	151	98	43	108	6,3	3
9,701-10,200	10	162	107	45	117	7,0	3
10,201-10,600	10,5	162	107	45	117	7,0	3
10,601-11,200	11	173	114	45	128	7,7	3
11,201-11,700	11,5	173	114	45	128	7,7	3
11,701-12,200	12	184	123	47	137	8,4	3
12,401-13,200	13	184	123	47	137	9,1	3
13,401-14,200	14	194	132	47	147	9,8	3
14,401-15,200	15	202	137	50	152	10,5	3
15,401-16,200	16	211	143	53	158	11,2	3
16,401-17,200	17	218	146	52	166	11,9	3
17,401-18,200	18	226	152	56	170	12,6	3
18,401-19,200	19	234	158	58	176	13,3	3
19,201-20,200	20	242	164	60	182	14,0	3

Dimensions in mm.

Order example:

1. BECK product code

0 5 0 0 1 0 -

BECK product code

Hyphen

2. Diameter

0 8 . 2 0 0

Bore diameter

3. Tolerance

h 8

IT or tolerance in µm

Core drill - full size I 050110

Preferred series with Morse taper shank

Design:

Diameter:
Cutting direction:
Cutting material:
Flute direction:

8,00-50,00 mm
Right-hand cutting
HSS
Approx. 27°
right-hand spiral

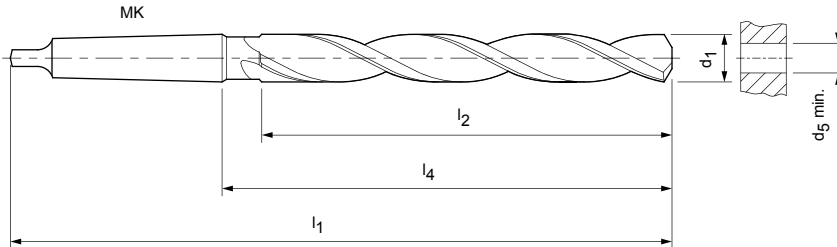

Dimensions						z	Order No.
d_1 h8	l_1	l_2	l_4	MK	$d_5 \text{ min}$		
8,00	156	68	90,5	1	5,6	3	30110381
9,00	162	74	96,5	1	6,3	3	30110383
10,00	168	80	102,5	1	7,0	3	30110385
11,00	175	84	109,5	1	7,7	3	30110387
12,00	182	91	116,5	1	8,4	3	30110389
13,00	182	91	116,5	1	9,1	3	30110391
14,00	189	98	123,5	1	9,8	3	30110393
15,00	212	106	132	2	10,5	3	30110395
16,00	218	108	138	2	11,2	3	30110397
17,00	223	113	143	2	11,9	3	30110399
18,00	228	118	148	2	12,6	3	30110401
19,00	233	123	153	2	13,3	3	30110403
20,00	238	128	158	2	14,0	3	30110405
21,00	243	129	163	2	14,6	3	30110407
22,00	248	134	168	2	15,3	3	30110409
23,00	253	139	173	2	16,0	3	30110411
24,00	281	148	182	3	16,6	3	30110413
25,00	281	144	182	3	17,3	3	30110415
26,00	286	149	187	3	18,0	3	30110417
27,00	291	154	192	3	18,6	3	30110419
28,00	291	162	192	3	19,3	3	30110421
29,00	296	167	197	3	20,0	3	30110423
30,00	296	167	197	3	20,5	3	30110425
31,00	301	170	202	3	21,0	3	30110427
32,00	334	178	210	4	22,0	3	30110429
33,00	334	178	210	4	23,0	3	30110431
34,00	339	183	215	4	24,0	3	30110433
35,00	339	181	215	4	25,0	3	30110435
36,00	344	186	220	4	25,5	3	30110437
37,00	344	186	220	4	26,0	3	30110439
38,00	349	191	225	4	26,5	3	30110441
39,00	349	189	225	4	27,0	3	30110443
40,00	349	189	225	4	28,0	3	30110445
41,00	354	194	230	4	28,5	3	30110447
42,00	354	194	230	4	29,0	3	30110449

Core drill, full size I 050110, preferred series with Morse taper shank

Dimensions						z	Order No.
d ₁ h8	l ₁	l ₂	l ₄	MK	d ₅ min		
43,00	359	197	235	4	30,0	3	30110451
44,00	359	197	235	4	30,5	3	30110453
45,00	359	197	235	4	31,0	3	30110455
46,00	364	202	240	4	32,0	3	30110457
47,00	364	200	240	4	32,5	3	30110459
48,00	369	205	245	4	33,0	3	30110461
49,00	369	205	245	4	34,0	3	30110463
50,00	369	205	245	4	34,5	3	30110465

Dimensions in mm.

Intermediate diameters and special tolerances can be ordered by the overview pages for configurable series on page 357.

Core drill - under size I 050111

Preferred series with Morse taper shank

Design:

Diameter:
Cutting direction:
Cutting material:
Flute direction:

7,80-49,60 mm
Right-hand cutting
HSS
Approx. 27°
right-hand spiral

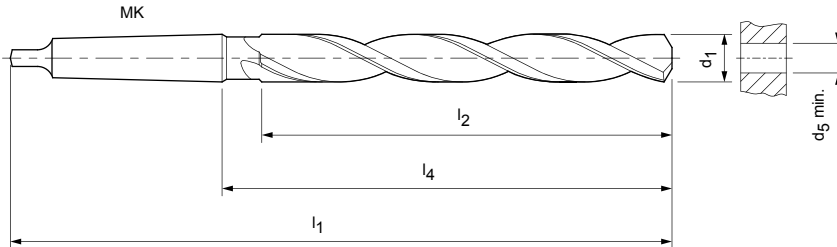

Dimensions						z	Order No.
$d_1 \text{ h8}$	l_1	l_2	l_4	MK	$d_5 \text{ min}$		
7,80	156	68	90,5	1	5,6	3	30110467
8,80	162	74	96,5	1	6,3	3	30110469
9,80	168	80	102,5	1	7,0	3	30110471
10,75	175	84	109,5	1	7,7	3	30110473
11,75	182	91	116,5	1	8,4	3	30110475
12,75	182	91	116,5	1	9,1	3	30110477
13,75	189	98	123,5	1	9,8	3	30110479
14,75	212	106	132	2	10,5	3	30110481
15,75	218	108	138	2	11,2	3	30110483
16,75	223	113	143	2	11,9	3	30110485
17,75	228	118	148	2	12,6	3	30110487
18,70	233	123	153	2	13,3	3	30110489
19,70	238	128	158	2	14,0	3	30110491
20,70	243	129	163	2	14,6	3	30110493
21,70	248	134	168	2	15,3	3	30110495
22,70	253	139	173	2	16,0	3	30110497
23,70	281	148	182	3	16,6	3	30110499
24,70	281	144	182	3	17,3	3	30110501
25,70	286	149	187	3	18,0	3	30110503
26,70	291	154	192	3	18,6	3	30110505
27,70	291	162	192	3	19,3	3	30110507
28,70	296	167	197	3	20,0	3	30110509
29,70	296	167	197	3	20,5	3	30110511
30,60	301	170	202	3	21,0	3	30110513
31,60	334	178	210	4	22,0	3	30110515
32,60	334	178	210	4	23,0	3	30110517
33,60	339	183	215	4	24,0	3	30110519
34,60	339	181	215	4	25,0	3	30110521
35,60	344	186	220	4	25,5	3	30110523
36,60	344	186	220	4	26,0	3	30110525
37,60	349	191	225	4	26,5	3	30110527
38,60	349	189	225	4	27,0	3	30110529
39,60	349	189	225	4	28,0	3	30110531
40,60	354	194	230	4	28,5	3	30110533
41,60	354	194	230	4	29,0	3	30110535

Core drill, under size I 050111, preferred series with Morse taper shank

Dimensions						z	Order No.
d ₁ h8	l ₁	l ₂	l ₄	MK	d ₅ min		
42,60	359	197	235	4	30,0	3	30110537
43,60	359	197	235	4	30,5	3	30110539
44,60	359	197	235	4	31,0	3	30110541
45,60	364	202	240	4	32,0	3	30110543
46,60	364	200	240	4	32,5	3	30110545
47,60	369	205	245	4	33,0	3	30110547
48,60	369	205	245	4	34,0	3	30110549
49,60	369	205	245	4	34,5	3	30110551

Core drill overview | 050110

Configurable series with Morse taper shank

Design:

Diameter: 7,600-50,200 mm
 Cutting direction: Right-hand cutting
 Cutting material: HSS
 Flute direction: Approx. 27° right-hand spiral

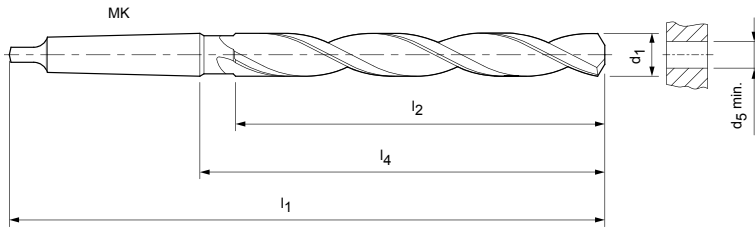

Dimensions						z
d ₁	l ₁	l ₂	l ₄	MK	d ₅ min	
7,600-8,200	156	68	90,5	1	5,6	3
8,201-8,700	156	68	90,5	1	5,6	3
8,701-9,200	162	74	96,5	1	6,3	3
9,201-9,700	162	74	96,5	1	6,3	3
9,701-10,200	168	80	102,5	1	7,0	3
10,201-10,700	168	80	102,5	1	7,0	3
10,701-11,200	175	84	109,5	1	7,7	3
11,201-11,700	175	84	109,5	1	7,7	3
11,701-12,200	182	91	116,5	1	8,4	3
12,201-12,700	182	91	116,5	1	9,1	3
12,701-13,200	182	91	116,5	1	9,1	3
13,201-13,700	189	98	123,5	1	9,8	3
13,701-14,200	189	98	123,5	1	9,8	3
14,201-14,700	212	106	132	2	10,5	3
14,701-15,200	212	106	132	2	10,5	3
15,201-15,700	218	108	138	2	11,2	3
15,701-16,200	218	108	138	2	11,2	3
16,201-16,700	223	113	143	2	11,9	3
16,701-17,200	223	113	143	2	11,9	3
17,201-17,700	228	118	148	2	12,6	3
17,701-18,200	228	118	148	2	12,6	3
18,201-19,200	233	123	153	2	13,3	3
19,201-20,200	238	128	158	2	14,0	3
20,201-21,200	243	129	163	2	14,6	3
21,201-22,200	248	134	168	2	15,3	3
22,201-23,200	253	139	173	2	16,0	3
23,201-24,200	281	148	182	3	16,6	3
24,201-25,200	281	144	182	3	17,3	3
25,201-26,200	286	149	187	3	18,0	3
26,201-27,200	291	154	192	3	18,6	3
27,201-28,200	291	162	192	3	19,3	3
28,201-29,200	296	167	197	3	20,0	3
29,201-30,200	296	167	197	3	20,5	3
30,201-31,200	301	170	202	3	21,0	3
31,201-32,200	334	178	210	4	22,0	3
32,201-33,200	334	178	210	4	23,0	3
33,201-34,200	339	183	215	4	24,0	3
34,201-35,200	339	181	215	4	25,0	3
35,201-36,200	344	186	220	4	25,5	3
36,201-37,200	344	186	220	4	26,0	3
37,201-38,200	349	191	225	4	26,5	3
38,201-39,200	349	189	225	4	27,0	3
39,201-40,200	349	189	225	4	28,0	3
40,201-41,200	354	194	230	4	28,5	3

Core drill I 050110, configurable series with Morse taper shank

Dimensions						z
d ₁	l ₁	l ₂	l ₄	MK	d ₅ min	
41,201-42,200	354	194	230	4	29,0	3
42,201-43,200	359	197	235	4	30,0	3
43,201-44,200	359	197	235	4	30,5	3
44,201-45,200	359	197	235	4	31,0	3
45,201-46,200	364	202	240	4	32,0	3
46,201-47,200	364	200	240	4	32,5	3
47,201-48,200	369	205	245	4	33,0	3
48,201-49,200	369	205	245	4	34,0	3
49,201-50,200	369	205	245	4	34,5	3

Dimensions in mm.

Order example:

1. BECK product code

0 5 0 1 1 0 -

BECK product code

Hyphen

2. Diameter

4 8 . 2 0 0

Bore diameter

3. Tolerance

h 8

IT or tolerance in µm

Shell core drill, full size I 050310

Locating bore with 1:30 taper and driving slot in acc. to DIN 138, suitable for tool holders in accordance to DIN 217

Design:

Diameter:
Cutting direction:
Cutting material:
Flute direction:

24,00-100,00 mm
Right-hand cutting
HSS
Approx. 15°
right-hand spiral

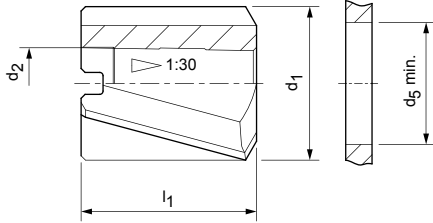

Dimensions				z	Order No.
d ₁ h8	l ₁	d ₂	d ₅ min		
24,00	45	13	20	4	30110598
25,00	45	13	21	4	30110600
26,00	45	13	22	4	30110602
27,00	45	13	23	4	30110604
28,00	45	13	24	4	30110606
29,00	45	13	25	4	30110608
30,00	45	13	26	4	30110610
31,00	45	13	27	4	30110612
32,00	45	13	28	4	30110614
33,00	45	13	29	4	30110616
34,00	45	13	30	4	30110618
35,00	45	13	31	4	30110620
36,00	50	16	31	4	30110622
37,00	50	16	32	4	30110624
38,00	50	16	33	4	30110626
39,00	50	16	34	4	30110628
40,00	50	16	35	4	30110630
42,00	50	16	37	4	30110632
44,00	50	16	39	4	30110634
45,00	50	16	40	4	30110636
46,00	56	19	40	4	30110638
47,00	56	19	41	4	30110640
48,00	56	19	42	4	30110642
50,00	56	19	44	4	30110644
52,00	56	19	46	4	30110646
55,00	63	22	48	4	30110648
58,00	63	22	51	4	30110650
60,00	63	22	53	4	30110652
62,00	63	22	55	4	30110654
65,00	71	27	57	4	30110656
68,00	71	27	60	4	30110658
70,00	71	27	62	4	30110660
72,00	71	27	64	4	30110662
75,00	71	27	67	4	30110664
78,00	80	32	68	6	30110666

Shell core drill, finish size I 050310, with 1:30 taper

Dimensions				z	Order No.
d ₁ h8	l ₁	d ₂	d ₅ min		
80,00	80	32	70	6	30110668
82,00	80	32	72	6	30110670
85,00	80	32	75	6	30110672
88,00	80	32	78	6	30110674
90,00	80	32	80	6	30110676
95,00	90	40	83	6	30110678
98,00	90	40	86	6	30110680
100,00	90	40	88	6	30110682

Dimensions in mm.

d₂ = nominal diameter d₁ of suitable holder!

Intermediate diameters and special tolerances can be ordered by the overview pages for configurable series on Page 363.

Shell core drill, under size I 050311

Locating bore with 1:30 taper and driving slot in acc. to DIN 138, suitable for tool holders in accordance to DIN 217

Design:

Diameter:
Cutting direction:
Cutting material:
Flute direction:

23,70-99,50 mm
Right-hand cutting
HSS
Approx. 15°
right-hand spiral

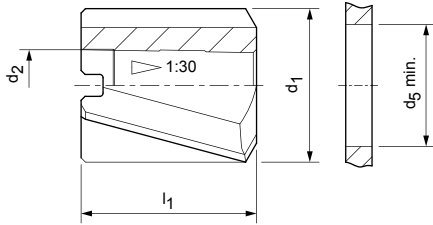

Dimensions				z	Order No.
d ₁ h8	l ₁	d ₂	d ₅ min		
23,70	45	13	20	4	30110684
24,70	45	13	21	4	30110686
25,70	45	13	22	4	30110688
26,70	45	13	23	4	30110690
27,70	45	13	24	4	30110692
28,70	45	13	25	4	30110694
29,70	45	13	26	4	30110696
30,60	45	13	27	4	30110698
31,60	45	13	28	4	30110700
32,60	45	13	29	4	30110702
33,60	45	13	30	4	30110704
34,60	45	13	31	4	30110706
35,60	50	16	31	4	30110708
36,60	50	16	32	4	30110710
37,60	50	16	33	4	30110712
38,60	50	16	34	4	30110714
39,60	50	16	35	4	30110716
41,60	50	16	37	4	30110718
43,60	50	16	39	4	30110720
44,60	50	16	40	4	30110722
45,60	56	19	40	4	30110724
46,60	56	19	41	4	30110726
47,60	56	19	42	4	30110728
49,60	56	19	44	4	30110730
51,50	56	19	46	4	30110732
54,50	63	22	48	4	30110734
57,50	63	22	51	4	30110736
59,50	63	22	53	4	30110738
61,50	63	22	55	4	30110740
64,50	71	27	57	4	30110742
67,50	71	27	60	4	30110744
69,50	71	27	62	4	30110746
71,50	71	27	64	4	30110748
74,50	71	27	67	4	30110750
77,50	80	32	68	6	30110752

Shell core drill, under size I 050311, with 1:30 taper

Dimensions				z	Order No.
d ₁ h8	l ₁	d ₂	d ₅ min		
79,50	80	32	70	6	30110754
81,50	80	32	72	6	30110756
84,50	80	32	75	6	30110758
87,50	80	32	78	6	30110760
89,50	80	32	80	6	30110762
94,50	90	40	83	6	30110764
97,50	90	40	86	6	30110766
99,50	90	40	88	6	30110768

Dimensions in mm.

d₂ = nominal diameter d₁ of suitable holder!

Shell core drill, overview I 050310

Configurable series, locating bore with 1:30 taper and driving slot in acc. to DIN 138, suitable for tool holders in accordance to DIN 217

Design:

Diameter: 23,200-100,200 mm
 Cutting direction: Right-hand cutting
 Cutting material: HSS
 Flute direction: Approx. 15° right-hand spiral

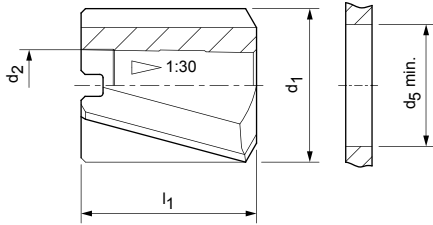

Dimensions				z
d_1	l_1	d_2	$d_5 \text{ min}$	
23,200-24,200	45	13	20	4
24,201-25,200	45	13	21	4
25,201-26,200	45	13	22	4
26,201-27,200	45	13	23	4
27,201-28,200	45	13	24	4
28,201-29,200	45	13	25	4
29,201-30,200	45	13	26	4
30,201-31,200	45	13	27	4
31,201-32,200	45	13	28	4
32,201-33,200	45	13	29	4
33,201-34,200	45	13	30	4
34,201-35,200	45	13	31	4
35,201-36,200	50	16	31	4
36,201-37,200	50	16	32	4
37,201-38,200	50	16	33	4
38,201-39,200	50	16	34	4
39,201-40,200	50	16	35	4
41,201-42,200	50	16	37	4
43,201-44,200	50	16	39	4
44,201-45,200	50	16	40	4
45,201-46,200	56	19	40	4
46,201-47,200	56	19	41	4
47,201-48,200	56	19	42	4
49,201-50,200	56	19	44	4
51,201-52,200	56	19	46	4
54,201-55,200	63	22	48	4
57,201-58,200	63	22	51	4
59,201-60,200	63	22	53	4
61,201-62,200	63	22	55	4
64,201-65,200	71	27	57	4
67,201-68,200	71	27	60	4
69,201-70,200	71	27	62	4
70,201-72,200	71	27	64	4
74,201-75,200	71	27	67	4
76,201-78,200	80	32	68	6

Shell core drill, configurable series I 050310, with 1:30 taper

Dimensions				z
d ₁	l ₁	d ₂	d ₅ min	
79,201-80,200	80	32	70	6
81,201-82,200	80	32	72	6
84,201-85,200	80	32	75	6
86,501-88,200	80	32	78	6
88,501-90,200	80	32	80	6
93,501-95,200	90	40	83	6
96,501-98,200	90	40	86	6
98,501-100,200	90	40	88	6

Dimensions in mm.

d₂ = nominal diameter d₁ of suitable holder!

Holder I 031610, 031611, 031612

With 1:30 taper, with driving ring and release nut, for shell reamers DIN 219, DIN 8054 and shell core drills DIN 222

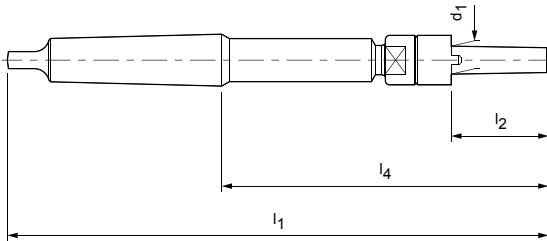

Dimensions								031610	031611	031612
d ₁	DIN 219	DIN 8054	DIN 222	l ₁	l ₂	l ₄	MK	Order No.	Order No.	Order No.
13,00	25-30	25-35	24-35	250	45	151	3	30107905		
16,00	31-35	36-45	36-45	261	50	162	3	30107907		
19,00	36-42	46-52	46-53	298	56	174	4	30107909		
19,00	36-42	46-52	46-53	273	56	174	3		30107921	
22,00	43-50	53-62	54-63	312	63	188	4	30107911		
22,00	43-50	53-62	54-63	287	63	188	3		30107923	
27,00	51-60	63-75	64-75	359	71	203	5	30107913		
27,00	51-60	63-75	64-75	327	71	203	4			30107925
32,00	61-71		76-90	376	80	220	5	30107915		
32,00	61-71		76-90	344	80	220	4			30107927
40,00	72-85		91-100	396	90	240	5	30107917		
50,00	86-100			416	100	260	5	30107919		

The following spare parts are also available from our stock:

Driving rings | 031511

Release nuts | 031512

Washers | 031513





TECHNICAL APPENDIX

Cutting data recommendations

Index	368
HNC reamers	370
PcBN reamers	376
HNC ecoSpeed	380
MR reamers	382
RR 01 reamers	386
VR 01 reamers	388
XR 01 reamers	394
XR 06 reamers	394
Cutting rings MultiCut	398
Machine reamers, carbide, uncoated	400
Machine reamers carbide, coated	402
Machine reamers, HSS-E, coated/uncoated	404
Countersink EUC-Speed, HSS, coated	406
Countersink EUC-Speed, solid carbide, coated	408
Countersink 90°, solid carbide	410
Countersink 90°/60°, HSS, coated/uncoated	412

Handling notes

XR replaceable head reamers	414
Cutting rings MultiCut	415

Index cutting data

High-performance reamers with cylindrical shank form

HNC reamers

Name	Cutting material	Product code	Page
HNC	Solid carbide	040260	370
HNC	Solid carbide	040261	370
HNC-Speed	Solid carbide, BSP coated	043260	370
HNC-Speed	Solid carbide, BSP coated	043261	370
HNC-VA	Solid carbide, BVA coated	043270	372
HNC-VA	Solid carbide, BVA coated	043271	372
HNC-TI	Solid carbide, BTI coated	043272	374
HNC-TI	Solid carbide, BTI coated	043273	374
HNC-AL	Solid carbide, BAL coated	043250	374
HNC-AL	Solid carbide, BAL coated	043251	374
HNC-HT	Solid carbide, BHV coated	043280	376
HNC-HT	Solid carbide, BHV coated	043281	376
HNC-Diamond	Solid carbide, diamond coated	043290	372
HNC-Diamond	Solid carbide, diamond coated	043291	372
PcBN reamers	PcBN	040356	376
PcBN reamers	PcBN	040366	376
HNC-Short	Solid carbide, BSP coated	043265	378
HCS	Cermet, uncoated	040360	378
HNC ecoSpeed	HSS, coated	033260	380
HNC ecoSpeed	HSS, coated	033261	380

MR reamers

Name	Cutting material	Product code	Page
MR 01	Carbide, uncoated	041610	382
MR 01	Carbide, uncoated	041650	382
MR 02	Carbide, uncoated	041710	382
MR 02	Carbide, uncoated	041750	382
MR 03	Carbide, uncoated	041810	382
MR 03	Carbide, uncoated	041850	382
MR 01	Carbide, BSP coated	041611	382
MR 01	Carbide, BSP coated	041651	382
MR 02	Carbide, BSP coated	041711	382
MR 02	Carbide, BSP coated	041751	382
MR 03	Carbide, BSP coated	041811	382
MR 03	Carbide, BSP coated	041851	382
MR 01	Cermet, uncoated	041612	384
MR 01	Cermet, uncoated	041652	384
MR 02	Cermet, uncoated	041712	384
MR 02	Cermet, uncoated	041752	384
MR 03	Cermet, uncoated	041812	384
MR 03	Cermet, uncoated	041852	384

RR 01 reamers

Name	Cutting material	Product code	Page
RR01	Cermet, uncoated	040325	386
RR01	Cermet, uncoated	040340	386
RR01	Cermet, uncoated	040326	386
RR01	Cermet, uncoated	040341	386
RR01 expandable version	Cermet, uncoated	040327	386

VR 01 reamers

Name	Cutting material	Product code	Page
VR 01	Solid carbide	040390	388
VR 01	Carbide, BSP coated	040382	388
VR 01	Carbide, uncoated	040370	390
VR 01	Cermet, uncoated	040372	390
VR 01	CBN for cast iron	040378	390
VR 01	CBN for hard machining	040376	392
VR 01	PCD	040374	392

Modular reaming

XR replaceable head reamers

Name	Cutting material	Product code	Page
XR 06	Solid carbide, BSP coated	081631	394
XR 06	Solid carbide, BSP coated	081661	394
XR 01	Carbide, BSP coated	081618	394
XR 01	Carbide, BSP coated	081651	394
XR 01	Carbide, uncoated	081610	394
XR 01	Carbide, uncoated	081650	394
XR 01	Carbide, BVA coated	081611	396
XR 01	Carbide, BVA coated	081659	396
XR 01	Cermet, uncoated	081612	396
XR 01	Cermet, uncoated	081652	396
XR 01	PCD	081605	394
XR 01	PCD	081655	394

MultiCut cutting rings

Name	Cutting material	Product code	Page
Cutting ring	Carbide, uncoated	MN73101	398
Cutting ring	Carbide, TiN coated	MN73102	398
Cutting ring	Cermet, uncoated	MN73104	398

Shell reamers

Name	Cutting material	Product code	Page
Shell reamer	Carbide, uncoated	040910	400
Shell reamer	HSS-E, uncoated	031211	404
Shell reamer	HSS-E, uncoated	031310	404

Parameters:

The recommended parameters are reference values.
These can be adapted depending on the application environment (machine, fixture).

Reaming without internal cooling

Machine reamers with carbide cutting edges, uncoated

Name	Cutting material	Product code	Page
DIN 8093-2 A	Carbide, uncoated	040210	400
Micro reamers sDIN 8093 B	Solid carbide, uncoated	040240	400
DIN 8093-2 B	Carbide, uncoated	040211	400
NC reamers sDIN 8093 B	Carbide, uncoated	040245	400
DIN 8093-1 A	Carbide, uncoated	040200	400
DIN 8093-1 B	Carbide, uncoated	040201	400
DIN 8090 B	Solid carbide, uncoated	040230	400
DIN 8094 A, carbide head	Solid carbide, uncoated	040420	400
DIN 8094 B, carbide head	Solid carbide, uncoated	040422	400
DIN 8094 A, carbide	Carbide, uncoated	040421	400
DIN 8094 B, carbide	Carbide, uncoated	040423	400
Expandable reamer sDIN 8050	Carbide, uncoated	040311	400
Expandable reamer sDIN 8051	Carbide, uncoated	040511	400
WN 280, pre cutting step	Carbide, uncoated	040512	400

Machine reamers with carbide cutting edges, coated

Name	Cutting material	Product code	Page
DIN 8093-2 B	Carbide, TiAlN coated	043211	402

Machine reamers made of HSS-E, coated and uncoated

Name	Cutting material	Product code	Page
DIN 212-3 B	HSS-E, uncoated	030505	404
Set DIN 212-3 B	HSS-E, uncoated	030507	404
DIN 212-1 A / DIN 212-2 A	HSS-E, uncoated	030510	404
DIN 212-1 B / DIN 212-2 B	HSS-E, uncoated	030511	404
DIN 212-2 B	HSS-E, TiN coated	033511	404
DIN 212-1 B / DIN 212-2 B	HSS-E, uncoated	030513	404
DIN 208 A	HSS-E, uncoated	030110	404
DIN 208 B	HSS-E, uncoated	030111	404
DIN 208 B	HSS-E, TiN coated	033111	404
DIN 8089 B	HSS-E, uncoated	030716	404
DIN 212-1 and DIN 212-2, Form C	HSS-E, uncoated	030610	404
DIN 208, Form C	HSS-E, uncoated	030310	404
DIN 311	HSS, uncoated	030010	404
WN 141 with face cut	HSS-E, uncoated	030810	404
WN 142 with face cut	HSS-E, uncoated	030811	404

Countersinking

Name	Cutting material	Product code	Page
EUC-Speed	Solid carbide, coated	044210	408
EUC-Speed	HSS, coated	054210	406
Countersink acc. to DIN	Solid carbide, uncoated	041020	410
Countersink acc. to DIN	HSS, coated/uncoated		412

Cutting data for HNC reamers

Feed f [mm/rev], cutting speed v_c [m/min] and allowance a [mm]

HNC I 040260

Cutting material: solid carbide, uncoated

HNC I 040261

Cutting material: solid carbide, uncoated

ZG*	Material	Strength/Hardness [N/mm ²] [HRC]	Cutting data for ϕ [mm]						
			< 5			5-6,2			
			v_c	f	a	v_c	f	a	
N1	N1.1	Aluminium, non-alloyed and alloyed <3% Si	50	0,15	0,15	50	0,15	0,15	
	N1.2	Aluminium, alloyed <=7% Si	50	0,15	0,15	50	0,15	0,15	
	N1.3	Aluminium, alloyed > 7-12% Si	30	0,15	0,15	30	0,15	0,15	
	N1.4	Aluminium, alloyed > 12% Si	30	0,15	0,15	30	0,15	0,15	
N2	N2.1	Copper, non-alloyed and low alloyed	< 300 N/mm ²	50	0,15	0,10	50	0,18	0,10
	N2.2	Copper, alloyed	> 300 N/mm ²	50	0,15	0,10	50	0,18	0,10
	N2.3	Brass, bronze, gun metal	< 1200 N/mm ²	50	0,15	0,10	50	0,18	0,10
N3	N3.1	Graphite							
N4	N4.1	Plastic, thermoplastic	40	0,15	0,15	40	0,15	0,15	
	N4.2	Plastic, thermosetting plastic (duroplast)	40	0,15	0,15	40	0,15	0,15	
	N4.3	Plastic, foam	40	0,15	0,15	40	0,15	0,15	

HNC-Speed I 043260

Cutting material: solid carbide, BSP coated

HNC-Speed I 043261

Cutting material: solid carbide, BSP coated

ZG*	Material	Strength/Hardness [N/mm ²] [HRC]	Cutting data for ϕ [mm]						
			< 5			5-6,2			
			v_c	f	a	v_c	f	a	
P	P1.1	Structural, free-cutting, case hardened and heat-treated steel, non-alloyed	< 700 N/mm ²	180	0,20	0,10	180	0,30	0,10
	P1.2	Structural, free-cutting, case hardened and heat-treated steel, non-alloyed	< 1200 N/mm ²	140	0,20	0,10	140	0,30	0,10
	P2.1	Nitrated, case hardened and heat-treated steel, alloyed	< 900 N/mm ²	180	0,20	0,10	180	0,30	0,10
	P2.2	Nitrated, case hardened and heat-treated steel, alloyed	< 1400 N/mm ²	140	0,20	0,10	140	0,30	0,10
	P3.1	Tool, roller bearing, spring and high speed steel	< 900 N/mm ²	180	0,20	0,10	180	0,30	0,10
	P3.2	Tool, roller bearing, spring and high speed steel	< 1500 N/mm ²	140	0,20	0,10	140	0,30	0,10
	P4.1	Stainless steel, ferritic and martensitic							
	P5.1	Cast steel		140	0,20	0,10	140	0,30	0,10
P6.1	Stainless cast steel, ferritic and martensitic								
K	K1.1	Cast iron with lamellar graphite (grey cast iron), EN-GJL	< 300 N/mm ²	110	0,30	0,10	110	0,40	0,10
	K2.1	Cast iron with spheroidal graphite, EN-GJS	< 500 N/mm ²	150	0,30	0,10	150	0,40	0,10
	K2.2	Cast iron with spheroidal graphite, EN-GJS	500-800 N/mm ²	90	0,30	0,10	90	0,40	0,10
	K2.3	Cast iron with spheroidal graphite, EN-GJS	> 800 N/mm ²	90	0,30	0,10	90	0,40	0,10
	K3.1	Cast iron with vermicular graphite, EN-GJV; Malleable cast iron, GJM	< 500 N/mm ²	90	0,30	0,10	90	0,40	0,10
	K3.2	Cast iron with vermicular graphite, EN-GJV; Malleable cast iron, GJM	> 500 N/mm ²	90	0,30	0,10	90	0,40	0,10

Cutting data for ϕ [mm]												
> 6,2-8			> 8-12			> 12-16,2			> 16,2-20,2			
v_c	f	a	v_c	f	a	v_c	f	a	v_c	f	a	
50	0,15	0,15	50	0,20	0,20	50	0,20	0,20	50	0,30	0,30	
50	0,15	0,15	50	0,20	0,20	50	0,20	0,20	50	0,30	0,30	
30	0,15	0,15	30	0,20	0,20	30	0,20	0,20	30	0,30	0,30	
30	0,15	0,15	30	0,20	0,20	30	0,20	0,20	30	0,30	0,30	
50	0,18	0,10	50	0,20	0,20	50	0,30	0,20	50	0,35	0,30	
50	0,18	0,10	50	0,20	0,20	50	0,30	0,20	50	0,35	0,30	
50	0,18	0,10	50	0,20	0,20	50	0,30	0,20	50	0,35	0,30	
40	0,15	0,15	40	0,35	0,20	40	0,35	0,20	40	0,40	0,30	
40	0,15	0,15	40	0,35	0,20	40	0,35	0,20	40	0,40	0,30	
40	0,15	0,15	40	0,35	0,20	40	0,35	0,20	40	0,40	0,30	

Cutting data for ϕ [mm]												
> 6,2-8			> 8-12			> 12-16,2			> 16,2-20,2			
v_c	f	a	v_c	f	a	v_c	f	a	v_c	f	a	
180	0,50	0,10	180	0,80	0,15	180	1,10	0,20	180	1,50	0,20	
140	0,50	0,10	140	0,80	0,15	140	1,10	0,20	140	1,50	0,20	
180	0,50	0,10	180	0,80	0,15	180	1,10	0,20	180	1,50	0,20	
140	0,50	0,10	140	0,80	0,15	140	1,10	0,20	140	1,50	0,20	
180	0,50	0,10	180	0,80	0,15	180	1,10	0,20	180	1,50	0,20	
140	0,50	0,10	140	0,80	0,15	140	1,10	0,20	140	1,50	0,20	
140	0,50	0,10	140	0,80	0,15	140	1,10	0,20	140	1,50	0,20	
110	0,60	0,10	110	1,00	0,20	110	1,30	0,20	110	1,80	0,30	
150	0,60	0,15	150	1,00	0,20	150	1,30	0,20	150	1,80	0,30	
90	0,60	0,15	90	1,00	0,20	90	1,30	0,20	90	1,80	0,30	
90	0,60	0,15	90	1,00	0,20	90	1,30	0,20	90	1,80	0,30	
90	0,60	0,15	90	1,00	0,20	90	1,30	0,20	90	1,80	0,30	
90	0,60	0,15	90	1,00	0,20	90	1,30	0,20	90	1,80	0,30	

Parameters:

The recommended parameters are reference values.

These can be adapted depending on the application environment (machine, fixture).

Cutting data for HNC reamers

Feed f [mm/rev], cutting speed v_c [m/min] and allowance a [mm]

HNC-VA | 043270

Cutting material: solid carbide, BVA coated

HNC-VA | 043271

Cutting material: solid carbide, BVA coated

ZG*	Material	Strength/Hardness [N/mm ²] [HRC]	Cutting data for ϕ [mm]						
			< 5			5-6,2			
			v_c	f	a	v_c	f	a	
P	P1.1	Structural, free-cutting, case hardened and heat-treated steel, non-alloyed	< 700 N/mm ²						
	P1.2	Structural, free-cutting, case hardened and heat-treated steel, non-alloyed	< 1200 N/mm ²						
	P2.1	Nitrated, case hardened and heat-treated steel, alloyed	< 900 N/mm ²						
	P2.2	Nitrated, case hardened and heat-treated steel, alloyed	< 1400 N/mm ²						
	P3.1	Tool, roller bearing, spring and high speed steel	< 900 N/mm ²						
	P3.2	Tool, roller bearing, spring and high speed steel	< 1500 N/mm ²						
P4	P4.1	Stainless steel, ferritic and martensitic		40	0,10	0,05	40	0,15	0,10
P5	P5.1	Cast steel							
P6	P6.1	Stainless cast steel, ferritic and martensitic		40	0,10	0,05	40	0,15	0,10
M	M1.1	Stainless steel, austenitic	< 700 N/mm ²	40	0,10	0,05	40	0,15	0,10
	M1.2	Stainless steel, ferritic/austenitic (Duplex)	< 1000 N/mm ²	30	0,10	0,05	30	0,15	0,10
	M2.1	Stainless cast steel, austenitic	< 700 N/mm ²	40	0,10	0,05	40	0,15	0,10
	M3.1	Stainless cast steel, ferritic/austenitic (Duplex)	< 1000 N/mm ²	30	0,10	0,05	30	0,15	0,10

HNC-Diamond | 043290

Cutting material: solid carbide, diamond coated

HNC-Diamond | 043291

Cutting material: solid carbide, diamond coated

ZG*	Material	Cutting data for ϕ [mm]						
		< 5			5-6,2			
		v_c	f	a	v_c	f	a	
C	C1.1	Plastic matrix, aramid fibre reinforced plastic (AFK)	50	0,25	0,20	50	0,25	0,20
	C1.2	Plastic matrix (thermosetting), CFRP/GFRP	50	0,25	0,20	50	0,25	0,20
	C1.3	Plastic matrix (thermoplastic), CFRP/GFRP	50	0,25	0,20	50	0,25	0,20
	C2.1	Carbon matrix, carbon fibre reinforced (CFC)						
	C3.1	Metal matrix (MMC)						
	C4.1	Sandwich construction, honeycomb core of paper						
	C4.2	Sandwich construction, honeycomb core of aluminium						
	C4.3	Sandwich construction, honeycomb core of plastic and fibre composite materials						
	C4.4	Sandwich construction, core of rigid foam						
	C5.1	Stack (hybrid structure) CFRP-aluminium						
	C5.2	Stack (hybrid structure) CFRP-titanium/stainless steel						

Cutting data for HNC reamers

Feed f [mm/rev], cutting speed v_c [m/min] and allowance a [mm]

HNC-TI | 043272

Cutting material: solid carbide, BTI coated

HNC-TI | 043273

Cutting material: solid carbide, BTI coated

ZG*	Material	Strength/Hardness [N/mm ²] [HRC]	Cutting data for ϕ [mm]						
			< 5			5-6,2			
			v_c	f	a	v_c	f	a	
S	S1 S1.1	Titanium, titanium alloy	< 400 N/mm ²	15	0,08	0,05	15	0,12	0,05
	S2 S2.1	Titanium, titanium alloy	< 1200 N/mm ²	15	0,08	0,05	15	0,12	0,05
	S2 S2.2	Titanium, titanium alloy	> 1200 N/mm ²	15	0,08	0,05	15	0,12	0,05
	S3 S3.1	Nickel, non-alloyed and alloyed	< 900 N/mm ²	15	0,08	0,05	15	0,12	0,05
	S3 S3.2	Nickel, non-alloyed and alloyed	> 900 N/mm ²	15	0,08	0,05	15	0,12	0,05
	S4 S4.1	Heat resistant super alloys, Ni, Co, and Fe based		15	0,08	0,05	15	0,12	0,05
	S5 S5.1	Tungsten and molybdenum alloys		15	0,08	0,05	15	0,12	0,05

HNC-AL | 043250

Cutting material: solid carbide, BAL coated

HNC-AL | 043251

Cutting material: solid carbide, BAL coated

ZG*	Material	Strength/Hardness [N/mm ²] [HRC]	Cutting data for ϕ [mm]						
			< 5			5-6,2			
			v_c	f	a	v_c	f	a	
N1	N1.1	Aluminium, non-alloyed and alloyed <3% Si		250	0,50	0,10	250	0,60	0,10
	N1.2	Aluminium, alloyed <=7% Si		250	0,50	0,10	250	0,60	0,10
	N1.3	Aluminium, alloyed > 7-12% Si		250	0,50	0,10	250	0,60	0,10
	N1.4	Aluminium, alloyed > 12% Si		250	0,50	0,10	250	0,60	0,10
N2	N2.1	Copper, non-alloyed and low alloyed	< 300 N/mm ²						
	N2.2	Copper, alloyed	> 300 N/mm ²						
	N2.3	Brass, bronze, gun metal	< 1200 N/mm ²						
N3	N3.1	Graphite							
N4	N4.1	Plastic, thermoplastic							
	N4.2	Plastic, thermosetting plastic (duroplast)							
	N4.3	Plastic, foam							

	Cutting data for \varnothing [mm]											
	> 6,2-8			> 8-12			> 12-16,2			> 16,2-20,2		
	v_c	f	a	v_c	f	a	v_c	f	a	v_c	f	a
	15	0,15	0,10	15	0,15	0,10	15	0,20	0,15	15	0,25	0,20
	15	0,15	0,10	15	0,15	0,10	15	0,20	0,15	15	0,25	0,20
	15	0,15	0,10	15	0,15	0,10	15	0,20	0,15	15	0,25	0,20
	15	0,15	0,10	15	0,15	0,10	15	0,20	0,15	15	0,25	0,20
	15	0,15	0,10	15	0,15	0,10	15	0,20	0,15	15	0,25	0,20
	15	0,15	0,10	15	0,15	0,10	15	0,20	0,15	15	0,25	0,20
	15	0,15	0,10	15	0,15	0,10	15	0,20	0,15	15	0,25	0,20

	Cutting data for \varnothing [mm]											
	> 6,2-8			> 8-12			12-16,2			> 16,2-20		
	v_c	f	a	v_c	f	a	v_c	f	a	v_c	f	a
	250	0,80	0,10	250	1,30	0,20	250	1,50	0,30	250	1,80	0,30
	250	0,80	0,10	250	1,30	0,20	250	1,50	0,30	250	1,80	0,30
	250	0,80	0,10	250	1,30	0,20	250	1,50	0,30	250	1,80	0,30
	250	0,80	0,10	250	1,30	0,20	250	1,50	0,30	250	1,80	0,30

Parameters:

The recommended parameters are reference values.

These can be adapted depending on the application environment (machine, fixture).

Cutting data for HNC reamers

Feed f [mm/rev], cutting speed v_c [m/min] and allowance a [mm]

HNC-HT | 043280

Cutting material: solid carbide, BHV coated

HNC-HT | 043281

Cutting material: solid carbide, BHV coated

ZG*	Material		Strength/Hardness [N/mm ²] [HRC]	Cutting data for ϕ [mm]						
				< 5			5-6,2			
				v_c	f	a	v_c	f	a	
H	H1	H1.1	Hardened steel/cast steel	45-55 HRC	10	0,06	0,05	10	0,10	0,05
		H1.2	Hardened steel/cast steel	55-64 HRC	10	0,06	0,05	10	0,10	0,05
		H1.3	Hardened steel/cast steel	64-70 HRC						
	H2	H2.1	Wear resistant castings/chilled cast iron, GJN		10	0,06	0,05	10	0,10	0,05

PcBN reamers | 040356

PcBN reamers | 040366

ZG*	Material		Strength/Hardness [N/mm ²] [HRC]		
K	K1	K1.1	Cast iron with lamellar graphite (grey cast iron), EN-GJL	< 300 N/mm ²	
		K2.1	Cast iron with spheroidal graphite, EN-GJS	< 500 N/mm ²	
		K2.2	Cast iron with spheroidal graphite, EN-GJS	500-800 N/mm ²	
	K2	K2.3	Cast iron with spheroidal graphite, EN-GJS	> 800 N/mm ²	
		K3	K3.1	Cast iron with vermicular graphite, EN-GJV; Malleable cast iron, GJM	< 500 N/mm ²
			K3.2	Cast iron with vermicular graphite, EN-GJV; Malleable cast iron, GJM	> 500 N/mm ²
H	H1	H1.1	Hardened steel/cast steel	45-55 HRC	
		H1.2	Hardened steel/cast steel	55-64 HRC	
		H1.3	Hardened steel/cast steel	64-70 HRC	
	H2	H2.3	Wear resistant castings/chilled cast iron, GJN		

Cutting data for \varnothing [mm]															
> 6,2-8			> 8-12			> 12-16			> 16-16,2			> 16,2-20,2			
v_c	f	a	v_c	f	a	v_c	f	a	v_c	f	a	v_c	f	a	
10	0,12	0,05	10	0,12	0,10	10	0,18	0,10	10	0,18	0,20	10	0,18	0,20	
10	0,12	0,05	10	0,12	0,10	10	0,18	0,10	10	0,18	0,20	10	0,18	0,20	
10	0,12	0,05	10	0,12	0,10	10	0,18	0,10	10	0,18	0,20	10	0,18	0,20	

Cutting data for \varnothing [mm]													
3-3,7			> 3,7-5,7			> 5,7-7,2			> 7,2-10,2				
v_c	f	a	v_c	f	a	v_c	f	a	v_c	f	a		
200	0,16	0,10	200	0,24	0,20	200	0,50	0,20	200	0,80	0,20		
80	0,10	0,10	80	0,22	0,10	80	0,22	0,10	80	0,30	0,10		
80	0,08	0,10	80	0,15	0,10	80	0,15	0,10	80	0,25	0,10		

Parameters:

The recommended parameters are reference values.

These can be adapted depending on the application environment (machine, fixture).

Cutting data for HNC reamers

Feed f [mm/rev], cutting speed v_c [m/min] and allowance a [mm]

HNC-Short I 043265

Cutting material: solid carbide, BSP coated

ZG*	Material	Strength/Hardness [N/mm ²] [HRC]	Cutting data for ϕ [mm]							
			< 5			5-6,1				
			v_c	f	a	v_c	f	a		
P	P1	P1.1 Structural, free-cutting, case hardened and heat-treated steel, non-alloyed	< 700 N/mm ²	180	0,20	0,10	180	0,30	0,10	
		P1.2 Structural, free-cutting, case hardened and heat-treated steel, non-alloyed	< 1200 N/mm ²	140	0,20	0,10	140	0,30	0,10	
	P2	P2.1 Nitrated, case hardened and heat-treated steel, alloyed	< 900 N/mm ²	180	0,20	0,10	180	0,30	0,10	
		P2.2 Nitrated, case hardened and heat-treated steel, alloyed	< 1400 N/mm ²	140	0,20	0,10	140	0,30	0,10	
	P3	P3.1 Tool, roller bearing, spring and high speed steel	< 900 N/mm ²	180	0,20	0,10	180	0,30	0,10	
		P3.2 Tool, roller bearing, spring and high speed steel	< 1500 N/mm ²	140	0,20	0,10	140	0,30	0,10	
	P4	P4.1 Stainless steel, ferritic and martensitic								
	P5	P5.1 Cast steel		140	0,20	0,10	140	0,30	0,10	
	P6	P6.1 Stainless cast steel, ferritic and martensitic								
	K	K1	K1.1 Cast iron with lamellar graphite (grey cast iron), EN-GJL	< 300 N/mm ²	110	0,30	0,10	110	0,40	0,10
			K2.1 Cast iron with spheroidal graphite, EN-GJS	< 500 N/mm ²	150	0,30	0,10	150	0,40	0,10
		K2	K2.2 Cast iron with spheroidal graphite, EN-GJS	500-800 N/mm ²	90	0,30	0,10	90	0,40	0,10
K2.3 Cast iron with spheroidal graphite, EN-GJS			> 800 N/mm ²	90	0,30	0,10	90	0,40	0,10	
K3		K3.1 Cast iron with vermicular graphite, EN-GJV; Malleable cast iron, GJM	< 500 N/mm ²	90	0,30	0,10	90	0,40	0,10	
		K3.2 Cast iron with vermicular graphite, EN-GJV; Malleable cast iron, GJM	> 500 N/mm ²	90	0,30	0,10	90	0,40	0,10	

HCS I 040360

Cutting material: Cermet, uncoated

ZG*	Material	Strength/Hardness [N/mm ²] [HRC]		
P	P1	P1.1 Structural, free-cutting, case hardened and heat-treated steel, non-alloyed	< 700 N/mm ²	
		P1.2 Structural, free-cutting, case hardened and heat-treated steel, non-alloyed	< 1200 N/mm ²	
	P2	P2.1 Nitrated, case hardened and heat-treated steel, alloyed	< 900 N/mm ²	
		P2.2 Nitrated, case hardened and heat-treated steel, alloyed	< 1400 N/mm ²	
	P3	P3.1 Tool, roller bearing, spring and high speed steel	< 900 N/mm ²	
		P3.2 Tool, roller bearing, spring and high speed steel	< 1500 N/mm ²	
	P4	P4.1 Stainless steel, ferritic and martensitic		
	P5	P5.1 Cast steel		
	P6	P6.1 Stainless cast steel, ferritic and martensitic		
	K	K1	K1.1 Cast iron with lamellar graphite (grey cast iron), EN-GJL	< 300 N/mm ²
			K2.1 Cast iron with spheroidal graphite, EN-GJS	< 500 N/mm ²
		K2	K2.2 Cast iron with spheroidal graphite, EN-GJS	500-800 N/mm ²
K2.3 Cast iron with spheroidal graphite, EN-GJS			> 800 N/mm ²	
K3		K3.1 Cast iron with vermicular graphite, EN-GJV; Malleable cast iron, GJM	< 500 N/mm ²	
		K3.2 Cast iron with vermicular graphite, EN-GJV; Malleable cast iron, GJM	> 500 N/mm ²	

Cutting data for ϕ [mm]															
> 6,1-8			> 8-12			> 12-15,1			> 15,1-16			> 16-20,1			
v_c	f	a	v_c	f	a	v_c	f	a	v_c	f	a	v_c	f	a	
180	0,50	0,10	180	0,80	0,15	180	1,10	0,20	180	1,50	0,20	180	1,50	0,20	
140	0,50	0,10	140	0,80	0,15	140	1,10	0,20	140	1,50	0,20	140	1,50	0,20	
180	0,50	0,10	180	0,80	0,15	180	1,10	0,20	180	1,50	0,20	180	1,50	0,20	
140	0,50	0,10	140	0,80	0,15	140	1,10	0,20	140	1,50	0,20	140	1,50	0,20	
180	0,50	0,10	180	0,80	0,15	180	1,10	0,20	180	1,50	0,20	180	1,50	0,20	
140	0,50	0,10	140	0,80	0,15	140	1,10	0,20	140	1,50	0,20	140	1,50	0,20	
140	0,50	0,10	140	0,80	0,15	140	1,10	0,20	140	1,50	0,20	140	1,50	0,20	
110	0,60	0,10	110	1,00	0,20	110	1,30	0,20	110	1,80	0,30	110	1,80	0,30	
150	0,60	0,15	150	1,00	0,20	150	1,30	0,20	150	1,80	0,30	150	1,80	0,30	
90	0,60	0,15	90	1,00	0,20	90	1,30	0,20	90	1,80	0,30	90	1,80	0,30	
90	0,60	0,15	90	1,00	0,20	90	1,30	0,20	90	1,80	0,30	90	1,80	0,30	
90	0,60	0,15	90	1,00	0,20	90	1,30	0,20	90	1,80	0,30	90	1,80	0,30	
90	0,60	0,15	90	1,00	0,20	90	1,30	0,20	90	1,80	0,30	90	1,80	0,30	

Cutting data for ϕ [mm]												
< 5			5-5,7			> 5,7-8			> 8-12,1			
v_c	f	a	v_c	f	a	v_c	f	a	v_c	f	a	
140	0,10	0,10	140	0,15	0,10	140	0,40	0,10	140	0,60	0,20	
90	0,10	0,10	90	0,12	0,10	90	0,40	0,10	90	0,60	0,20	
140	0,10	0,10	140	0,15	0,10	140	0,40	0,10	140	0,60	0,20	
90	0,10	0,10	90	0,12	0,10	90	0,40	0,10	90	0,60	0,20	
120	0,10	0,10	120	0,12	0,10	120	0,40	0,10	120	0,60	0,20	
90	0,10	0,10	90	0,12	0,10	90	0,40	0,10	90	0,60	0,20	
90	0,10	0,10	90	0,12	0,10	90	0,40	0,10	90	0,60	0,20	
120	0,20	0,10	120	0,40	0,10	120	0,50	0,10	120	0,70	0,20	
90	0,20	0,10	90	0,40	0,10	90	0,50	0,10	90	0,70	0,20	
90	0,20	0,10	90	0,40	0,10	90	0,50	0,10	90	0,70	0,20	
90	0,20	0,10	90	0,40	0,10	90	0,50	0,10	90	0,70	0,20	
90	0,20	0,10	90	0,40	0,10	90	0,50	0,10	90	0,70	0,20	

Parameters:

The recommended parameters are reference values.

These can be adapted depending on the application environment (machine, fixture).

Cutting data for HNC reamers, HSS

Feed f [mm/rev], cutting speed v_c [m/min] and allowance a [mm]

HNC ecoSpeed | 033260

Cutting material: HSS, special coating

HNC ecoSpeed | 033261

Cutting material: HSS, special coating

ZG*		Material	Strength/Hardness [N/mm ²] [HRC]	Cutting data for \varnothing [mm]							
				6-8			> 8-10				
				v_c	f	a	v_c	f	a		
P	P1	P1.1	Structural, free-cutting, case hardened and heat-treated steel, non-alloyed	< 700 N/mm ²	45	0,12	0,10	45	0,15	0,10	
		P1.2	Structural, free-cutting, case hardened and heat-treated steel, non-alloyed	< 1200 N/mm ²	35	0,12	0,10	35	0,15	0,10	
	P2	P2.1	Nitrated, case hardened and heat-treated steel, alloyed	< 900 N/mm ²	45	0,12	0,10	45	0,15	0,10	
		P2.2	Nitrated, case hardened and heat-treated steel, alloyed	< 1400 N/mm ²	35	0,12	0,10	35	0,15	0,10	
	P3	P3.1	Tool, roller bearing, spring and high speed steel	< 900 N/mm ²	30	0,12	0,10	30	0,15	0,10	
		P3.2	Tool, roller bearing, spring and high speed steel	< 1500 N/mm ²	20	0,12	0,10	20	0,15	0,10	
	P4	P4.1	Stainless steel, ferritic and martensitic		15	0,12	0,10	15	0,15	0,10	
	P5	P5.1	Cast steel		15	0,12	0,10	15	0,15	0,10	
	P6	P6.1	Stainless cast steel, ferritic and martensitic								
	K	K1	K1.1	Cast iron with lamellar graphite (grey cast iron), EN-GJL	< 300 N/mm ²	40	0,15	0,15	40	0,20	0,15
			K2.1	Cast iron with spheroidal graphite, EN-GJS	< 500 N/mm ²	35	0,15	0,15	35	0,20	0,15
		K2	K2.2	Cast iron with spheroidal graphite, EN-GJS	500-800 N/mm ²	30	0,15	0,15	30	0,20	0,15
K2.3			Cast iron with spheroidal graphite, EN-GJS	> 800 N/mm ²	20	0,15	0,15	20	0,20	0,15	
K3		K3.1	Cast iron with vermicular graphite, EN-GJV; Malleable cast iron, GJM	< 500 N/mm ²	20	0,15	0,15	20	0,20	0,15	
		K3.2	Cast iron with vermicular graphite, EN-GJV; Malleable cast iron, GJM	> 500 N/mm ²	15	0,15	0,15	15	0,20	0,15	

Cutting data for ϕ [mm]															
> 10-14			> 14-20			> 20-25			> 25-30			> 30-40			
v_c	f	a	v_c	f	a	v_c	f	a	v_c	f	a	v_c	f	a	
45	0,18	0,15	45	0,25	0,20	45	0,30	0,30	45	0,40	0,30	45	0,45	0,30	
35	0,18	0,15	35	0,25	0,20	35	0,30	0,30	35	0,40	0,30	35	0,45	0,30	
45	0,18	0,15	45	0,25	0,20	45	0,30	0,30	45	0,40	0,30	45	0,45	0,30	
35	0,18	0,15	35	0,25	0,20	35	0,30	0,30	35	0,40	0,30	35	0,45	0,30	
30	0,18	0,15	30	0,25	0,20	30	0,30	0,30	30	0,40	0,30	30	0,45	0,30	
20	0,18	0,15	20	0,25	0,20	20	0,30	0,30	20	0,40	0,30	20	0,45	0,30	
15	0,18	0,15	15	0,25	0,20	15	0,30	0,30	15	0,40	0,30	15	0,45	0,30	
15	0,18	0,15	15	0,25	0,20	15	0,30	0,30	15	0,40	0,30	15	0,45	0,30	
40	0,25	0,20	40	0,30	0,20	40	0,40	0,30	40	0,50	0,30	40	0,60	0,30	
35	0,25	0,20	35	0,30	0,20	35	0,40	0,30	35	0,50	0,30	35	0,60	0,30	
30	0,25	0,20	30	0,30	0,20	30	0,40	0,30	30	0,50	0,30	30	0,60	0,30	
20	0,25	0,20	20	0,30	0,20	20	0,40	0,30	20	0,50	0,30	20	0,60	0,30	
20	0,25	0,20	20	0,30	0,20	20	0,40	0,30	20	0,50	0,30	20	0,60	0,30	
15	0,25	0,20	15	0,30	0,20	15	0,40	0,30	15	0,50	0,30	15	0,60	0,30	

Parameters:

The recommended parameters are reference values.

These can be adapted depending on the application environment (machine, fixture).

Cutting data for MR reamers

Feed f [mm/rev], cutting speed vc [m/min] and allowance a [mm]

MR 01 | MR 02 | MR 03 - for through bore and blind bore

Cutting material: carbide, uncoated

ZG*		Material	Strength/Hardness [N/mm ²] [HRC]
N	N1	N1.1 Aluminium, non-alloyed and alloyed <3% Si	
		N1.2 Aluminium, alloyed <=7% Si	
		N1.3 Aluminium, alloyed > 7-12% Si	
		N1.4 Aluminium, alloyed > 12% Si	
	N2	N2.1 Copper, non-alloyed and low alloyed	< 300 N/mm ²
		N2.2 Copper, alloyed	> 300 N/mm ²
		N2.3 Brass, bronze, gun metal	< 1200 N/mm ²
	N3	N3.1 Graphite	
		N4.1 Plastic, thermoplastic	
	N4	N4.2 Plastic, thermosetting plastic (duroplast)	
		N4.3 Plastic, foam	

MR 01 | MR 02 | MR 03 - for through bore and blind bore

Cutting material: carbide, BSP coated

ZG*		Material	Strength/Hardness [N/mm ²] [HRC]	
P	P1	P1.1 Structural, free-cutting, case hardened and heat-treated steel, non-alloyed	< 700 N/mm ²	
		P1.2 Structural, free-cutting, case hardened and heat-treated steel, non-alloyed	< 1200 N/mm ²	
	P2	P2.1 Nitrated, case hardened and heat-treated steel, alloyed	< 900 N/mm ²	
		P2.2 Nitrated, case hardened and heat-treated steel, alloyed	< 1400 N/mm ²	
	P3	P3.1 Tool, roller bearing, spring and high speed steel	< 900 N/mm ²	
		P3.2 Tool, roller bearing, spring and high speed steel	< 1500 N/mm ²	
	P4	P4.1 Stainless steel, ferritic and martensitic		
	P5	P5.1 Cast steel		
	P6	P6.1 Stainless cast steel, ferritic and martensitic		
	K	K1	K1.1 Cast iron with lamellar graphite (grey cast iron), EN-GJL	< 300 N/mm ²
			K2.1 Cast iron with spheroidal graphite, EN-GJS	< 500 N/mm ²
		K2	K2.2 Cast iron with spheroidal graphite, EN-GJS	500-800 N/mm ²
K2.3 Cast iron with spheroidal graphite, EN-GJS			> 800 N/mm ²	
K3		K3.1 Cast iron with vermicular graphite, EN-GJV; Malleable cast iron, GJM	< 500 N/mm ²	
		K3.2 Cast iron with vermicular graphite, EN-GJV; Malleable cast iron, GJM	> 500 N/mm ²	

	Cutting data for ϕ [mm]											
	8-9,7			> 9,7-16			> 16-29,2			> 29,2-40,2		
	v_c	f	a	v_c	f	a	v_c	f	a	v_c	f	a
	50	0,20	0,20	50	0,40	0,20	50	0,50	0,30	50	0,60	0,30
	50	0,20	0,20	50	0,40	0,20	50	0,50	0,30	50	0,60	0,30
	30	0,20	0,20	30	0,40	0,20	30	0,50	0,30	30	0,60	0,30
	30	0,20	0,20	30	0,40	0,20	30	0,50	0,30	30	0,60	0,30
	50	0,20	0,20	50	0,40	0,20	50	0,50	0,30	50	0,60	0,30
	50	0,20	0,20	50	0,40	0,20	50	0,50	0,30	50	0,60	0,30
	50	0,20	0,20	50	0,40	0,20	50	0,50	0,30	50	0,60	0,30
	40	0,20	0,20	40	0,40	0,20	40	0,50	0,30	40	0,60	0,30
	40	0,20	0,20	40	0,40	0,20	40	0,50	0,30	40	0,60	0,30
	40	0,20	0,20	40	0,40	0,20	40	0,50	0,30	40	0,60	0,30

	Cutting data for ϕ [mm]											
	8-9,7			> 9,7-16			> 16-29,2			> 29,2-40,2		
	v_c	f	a	v_c	f	a	v_c	f	a	v_c	f	a
	120	0,40	0,20	120	1,00	0,20	120	1,50	0,30	120	2,00	0,30
	120	0,40	0,20	120	1,00	0,20	120	1,50	0,30	120	2,00	0,30
	120	0,40	0,20	120	1,00	0,20	120	1,50	0,30	120	2,00	0,30
	120	0,60	0,20	120	1,00	0,20	120	1,50	0,30	120	2,00	0,30
	110	0,20	0,20	110	1,50	0,20	110	1,80	0,30	110	2,50	0,30
	110	0,20	0,20	110	1,50	0,20	110	1,80	0,30	110	2,50	0,30
	90	0,60	0,20	90	1,50	0,20	90	1,80	0,30	90	2,50	0,30
	90	0,60	0,20	90	1,50	0,20	90	1,80	0,30	90	2,50	0,30
	90	0,60	0,20	90	1,50	0,20	90	1,80	0,30	90	2,50	0,30
	90	0,60	0,20	90	1,50	0,20	90	1,80	0,30	90	2,50	0,30

Parameters:

The recommended parameters are reference values.

These can be adapted depending on the application environment (machine, fixture).

Cutting data for MR reamers

Feed f [mm/rev], cutting speed v_c [m/min] and allowance a [mm]

MR 01 | MR 02 | MR 03 - for through bore and blind bore

Cutting material: cermet, uncoated

ZG*		Material	Strength/Hardness [N/mm ²] [HRC]
P	P1	P1.1 Structural, free-cutting, case hardened and heat-treated steel, non-alloyed	< 700 N/mm ²
		P1.2 Structural, free-cutting, case hardened and heat-treated steel, non-alloyed	< 1200 N/mm ²
	P2	P2.1 Nitrated, case hardened and heat-treated steel, alloyed	< 900 N/mm ²
		P2.2 Nitrated, case hardened and heat-treated steel, alloyed	< 1400 N/mm ²
	P3	P3.1 Tool, roller bearing, spring and high speed steel	< 900 N/mm ²
		P3.2 Tool, roller bearing, spring and high speed steel	< 1500 N/mm ²
	P4	P4.1 Stainless steel, ferritic and martensitic	
	P5	P5.1 Cast steel	
	P6	P6.1 Stainless cast steel, ferritic and martensitic	
	K	K1	K1.1 Cast iron with lamellar graphite (grey cast iron), EN-GJL
K2.1 Cast iron with spheroidal graphite, EN-GJS			< 500 N/mm ²
K2		K2.2 Cast iron with spheroidal graphite, EN-GJS	500-800 N/mm ²
		K2.3 Cast iron with spheroidal graphite, EN-GJS	> 800 N/mm ²
K3		K3.1 Cast iron with vermicular graphite, EN-GJV; Malleable cast iron, GJM	< 500 N/mm ²
		K3.2 Cast iron with vermicular graphite, EN-GJV; Malleable cast iron, GJM	> 500 N/mm ²

Cutting data for \varnothing [mm]												
8-9,7			> 9,7-16			> 16-29,2			> 29,2-40,2			
v_c	f	a	v_c	f	a	v_c	f	a	v_c	f	a	
150	0,40	0,20	150	1,00	0,20	150	1,50	0,30	150	2,00	0,30	
130	0,40	0,20	130	1,00	0,20	130	1,50	0,30	130	2,00	0,30	
130	0,40	0,20	130	1,00	0,20	130	1,50	0,30	130	2,00	0,30	
90	0,40	0,20	90	1,00	0,20	90	1,50	0,30	90	2,00	0,30	
120	0,60	0,20	120	1,50	0,20	120	1,80	0,30	120	2,50	0,30	

Parameters:

The recommended parameters are reference values.

These can be adapted depending on the application environment (machine, fixture).

Cutting data for RR reamers

Feed f [mm/rev], cutting speed v_c [m/min] and allowance a [mm]

RR 01 | 040325

Cutting material: Vollcermet, uncoated

RR 01 | 040340

Cutting material: Vollcermet, uncoated

ZG*		Material	Strength/Hardness [N/mm ²] [HRC]
P	P1	P1.1 Structural, free-cutting, case hardened and heat-treated steel, non-alloyed	< 700 N/mm ²
		P1.2 Structural, free-cutting, case hardened and heat-treated steel, non-alloyed	< 1200 N/mm ²
	P2	P2.1 Nitrated, case hardened and heat-treated steel, alloyed	< 900 N/mm ²
		P2.2 Nitrated, case hardened and heat-treated steel, alloyed	< 1400 N/mm ²
	P3	P3.1 Tool, roller bearing, spring and high speed steel	< 900 N/mm ²
		P3.2 Tool, roller bearing, spring and high speed steel	< 1500 N/mm ²
	P4	P4.1 Stainless steel, ferritic and martensitic	
	P5	P5.1 Cast steel	
	P6	P6.1 Stainless cast steel, ferritic and martensitic	
	K	K1	K1.1 Cast iron with lamellar graphite (grey cast iron), EN-GJL
K2.1 Cast iron with spheroidal graphite, EN-GJS			< 500 N/mm ²
K2		K2.2 Cast iron with spheroidal graphite, EN-GJS	500-800 N/mm ²
		K2.3 Cast iron with spheroidal graphite, EN-GJS	> 800 N/mm ²
K3		K3.1 Cast iron with vermicular graphite, EN-GJV; Malleable cast iron, GJM	< 500 N/mm ²
		K3.2 Cast iron with vermicular graphite, EN-GJV; Malleable cast iron, GJM	> 500 N/mm ²

RR 01 | 040326

Cutting material: Cermet, uncoated

RR 01 | 040341

Cutting material: Cermet, uncoated

RR 01 | 040327

Cutting material: Cermet, uncoated

ZG*		Material	Strength/Hardness [N/mm ²] [HRC]
P	P1	P1.1 Structural, free-cutting, case hardened and heat-treated steel, non-alloyed	< 700 N/mm ²
		P1.2 Structural, free-cutting, case hardened and heat-treated steel, non-alloyed	< 1200 N/mm ²
	P2	P2.1 Nitrated, case hardened and heat-treated steel, alloyed	< 900 N/mm ²
		P2.2 Nitrated, case hardened and heat-treated steel, alloyed	< 1400 N/mm ²
	P3	P3.1 Tool, roller bearing, spring and high speed steel	< 900 N/mm ²
		P3.2 Tool, roller bearing, spring and high speed steel	< 1500 N/mm ²
	P4	P4.1 Stainless steel, ferritic and martensitic	
	P5	P5.1 Cast steel	
	P6	P6.1 Stainless cast steel, ferritic and martensitic	
	K	K1	K1.1 Cast iron with lamellar graphite (grey cast iron), EN-GJL
K2.1 Cast iron with spheroidal graphite, EN-GJS			< 500 N/mm ²
K2		K2.2 Cast iron with spheroidal graphite, EN-GJS	500-800 N/mm ²
		K2.3 Cast iron with spheroidal graphite, EN-GJS	> 800 N/mm ²
K3		K3.1 Cast iron with vermicular graphite, EN-GJV; Malleable cast iron, GJM	< 500 N/mm ²
		K3.2 Cast iron with vermicular graphite, EN-GJV; Malleable cast iron, GJM	> 500 N/mm ²

Cutting data for \varnothing [mm]																		
< 5			5-6,2			> 6,2-8			> 8-12			> 12-16,2			> 16,2-20,2			
v_c	f	a	v_c	f	a	v_c	f	a	v_c	f	a	v_c	f	a	v_c	f	a	
140	0,10	0,10	140	0,15	0,10	140	0,40	0,10	140	0,60	0,20	140	0,80	0,20	140	1,00	0,20	
90	0,10	0,10	90	0,12	0,10	90	0,40	0,10	90	0,60	0,20	90	0,80	0,20	90	1,00	0,20	
140	0,10	0,10	140	0,15	0,10	140	0,40	0,10	140	0,60	0,20	140	0,80	0,20	140	1,00	0,20	
90	0,10	0,10	90	0,12	0,10	90	0,40	0,10	90	0,60	0,20	90	0,80	0,20	90	1,00	0,20	
120	0,10	0,10	120	0,12	0,10	120	0,40	0,10	120	0,60	0,20	120	0,80	0,20	120	1,00	0,20	
90	0,10	0,10	90	0,12	0,10	90	0,40	0,10	90	0,60	0,20	90	0,80	0,20	90	1,00	0,20	
90	0,10	0,10	90	0,12	0,10	90	0,40	0,10	90	0,60	0,20	90	0,80	0,20	90	1,00	0,20	
120	0,20	0,10	120	0,40	0,10	120	0,50	0,10	120	0,70	0,20	120	1,20	0,20	120	1,60	0,20	
90	0,20	0,10	90	0,40	0,10	90	0,50	0,10	90	0,70	0,20	90	1,20	0,20	90	1,60	0,20	
90	0,20	0,10	90	0,40	0,10	90	0,50	0,10	90	0,70	0,20	90	1,20	0,20	90	1,60	0,20	
90	0,20	0,10	90	0,40	0,10	90	0,50	0,10	90	0,70	0,20	90	1,20	0,20	90	1,60	0,20	
90	0,20	0,10	90	0,40	0,10	90	0,50	0,10	90	0,70	0,20	90	1,20	0,20	90	1,60	0,20	

Cutting data for \varnothing [mm]																		
													> 20,2-29,2			> 29,2-40,2		
													v_c	f	a	v_c	f	a
													140	1,00	0,20	140	1,40	0,30
													90	1,00	0,20	90	1,40	0,30
													140	1,00	0,20	140	1,40	0,30
													90	1,00	0,20	90	1,40	0,30
													120	1,00	0,20	120	1,40	0,30
													90	1,00	0,20	90	1,40	0,30
													90	1,00	0,20	90	1,40	0,30
													120	1,60	0,20	120	2,00	0,30
													90	1,60	0,20	90	2,00	0,30
													90	1,60	0,20	90	2,00	0,30
													90	1,60	0,20	90	2,00	0,30
													90	1,60	0,20	90	2,00	0,30

Parameters:

The recommended parameters are reference values.
 These can be adapted depending on the application environment (machine, fixture).

Cutting data for VR reamers

Feed f [mm/rev], cutting speed v_c [m/min] and allowance a [mm]

VR 01 | 040390

Cutting material: solid carbide, BSP coated

ZG*	Material	Strength/Hardness [N/mm ²] [HRC]	
P	P1.1	Structural, free-cutting, case hardened and heat-treated steel, non-alloyed	
	P1.2	Structural, free-cutting, case hardened and heat-treated steel, non-alloyed	
	P2.1	Nitrated, case hardened and heat-treated steel, alloyed	
	P2.2	Nitrated, case hardened and heat-treated steel, alloyed	
	P3.1	Tool, roller bearing, spring and high speed steel	
	P3.2	Tool, roller bearing, spring and high speed steel	
	P4.1	Stainless steel, ferritic and martensitic	
	P5.1	Cast steel	
	P6.1	Stainless cast steel, ferritic and martensitic	
			< 700 N/mm ²
			< 1200 N/mm ²
			< 900 N/mm ²
		< 1400 N/mm ²	
		< 900 N/mm ²	
		< 1500 N/mm ²	

VR 01 | 040382

Cutting material: carbide, BSP coated

ZG*	Material	Strength/Hardness [N/mm ²] [HRC]	Cutting data for ϕ [mm]							
			9,76-11,75			> 11,75-13,75				
			v_c	f	a	v_c	f	a		
P	P1.1	Structural, free-cutting, case hardened and heat-treated steel, non-alloyed	< 700 N/mm ²	180	0,60	0,10	180	0,80	0,20	
	P1.2	Structural, free-cutting, case hardened and heat-treated steel, non-alloyed	< 1200 N/mm ²	120	0,60	0,10	120	0,80	0,20	
	P2.1	Nitrated, case hardened and heat-treated steel, alloyed	< 900 N/mm ²	150	0,60	0,10	150	0,80	0,20	
	P2.2	Nitrated, case hardened and heat-treated steel, alloyed	< 1400 N/mm ²	120	0,60	0,10	120	0,80	0,20	
	P3.1	Tool, roller bearing, spring and high speed steel	< 900 N/mm ²	150	0,60	0,10	150	0,80	0,20	
	P3.2	Tool, roller bearing, spring and high speed steel	< 1500 N/mm ²	120	0,60	0,10	120	0,80	0,20	
	P4.1	Stainless steel, ferritic and martensitic		40	0,40	0,10	40	0,50	0,10	
	P5.1	Cast steel		150	0,60	0,10	150	0,80	0,20	
	P6.1	Stainless cast steel, ferritic and martensitic		40	0,40	0,10	40	0,50	0,10	
	K	K1.1	Cast iron with lamellar graphite (grey cast iron), EN-GJL	< 300 N/mm ²	110	1,00	0,10	110	1,40	0,20
		K2.1	Cast iron with spheroidal graphite, EN-GJS	< 500 N/mm ²	150	1,00	0,10	150	1,40	0,20
		K2.2	Cast iron with spheroidal graphite, EN-GJS	500-800 N/mm ²	90	1,00	0,10	90	1,40	0,20
K2.3		Cast iron with spheroidal graphite, EN-GJS	> 800 N/mm ²	90	1,00	0,10	90	1,40	0,20	
K3.1		Cast iron with vermicular graphite, EN-GJV; Malleable cast iron, GJM	< 500 N/mm ²	90	1,00	0,10	90	1,40	0,20	
K3.2		Cast iron with vermicular graphite, EN-GJV; Malleable cast iron, GJM	> 500 N/mm ²	90	1,00	0,10	90	1,40	0,20	

Cutting data for ϕ [mm]														
5,7-6,2			> 6,2-10,2			> 10,2-12,2								
v_c	f	a	v_c	f	a	v_c	f	a						
180	0,60	0,10	180	0,80	0,10	180	1,00	0,10						
120	0,60	0,10	120	0,80	0,10	120	1,00	0,10						
150	0,60	0,10	150	0,80	0,10	150	1,00	0,10						
120	0,60	0,10	120	0,80	0,10	120	1,00	0,10						
150	0,60	0,10	150	0,80	0,10	150	1,00	0,10						
120	0,60	0,10	120	0,80	0,10	120	1,00	0,10						
150	0,60	0,10	150	0,80	0,10	150	1,00	0,10						

Cutting data for ϕ [mm]														
> 13,75-17,75			> 17,75-21,75			> 21,75-24,75			> 24,75-31,75			> 31,75-40,25		
v_c	f	a	v_c	f	a	v_c	f	a	v_c	f	a	v_c	f	a
180	1,00	0,20	180	1,10	0,20	180	1,20	0,20	180	1,40	0,20	180	1,50	0,20
120	1,00	0,20	120	1,10	0,20	120	1,20	0,20	120	1,40	0,20	120	1,50	0,20
150	1,00	0,20	150	1,10	0,20	150	1,20	0,20	150	1,40	0,20	150	1,50	0,20
120	1,00	0,20	120	1,10	0,20	120	1,20	0,20	120	1,40	0,20	120	1,50	0,20
150	1,00	0,20	150	1,10	0,20	150	1,20	0,20	150	1,40	0,20	150	1,50	0,20
120	1,00	0,20	120	1,10	0,20	120	1,20	0,20	120	1,40	0,20	120	1,50	0,20
40	0,60	0,15	40	0,70	0,20	40	0,80	0,20	40	1,00	0,20	40	1,10	0,20
150	1,00	0,20	150	1,10	0,20	150	1,20	0,20	150	1,40	0,20	150	1,50	0,20
40	0,60	0,15	40	0,70	0,20	40	0,80	0,20	40	1,00	0,20	40	1,10	0,20
110	1,80	0,20	110	2,00	0,20	110	2,50	0,20	110	3,00	0,20	110	3,50	0,20
150	1,80	0,20	150	2,00	0,20	150	2,50	0,20	150	3,00	0,20	150	3,50	0,20
90	1,80	0,20	90	2,00	0,20	90	2,50	0,20	90	3,00	0,20	90	3,50	0,20
90	1,80	0,20	90	2,00	0,20	90	2,50	0,20	90	3,00	0,20	90	3,50	0,20
90	1,80	0,20	90	2,00	0,20	90	2,50	0,20	90	3,00	0,20	90	3,50	0,20
90	1,80	0,20	90	2,00	0,20	90	2,50	0,20	90	3,00	0,20	90	3,50	0,20

Parameters:

The recommended parameters are reference values.

These can be adapted depending on the application environment (machine, fixture).

Cutting data for VR reamers

Feed f [mm/rev], cutting speed v_c [m/min] and allowance a [mm]

VR 01 I 040378

Cutting material: CBN

ZG*	Material	Strength/Hardness [N/mm ²] [HRC]	Cutting data for ϕ [mm]						
			9,76-11,75			> 11,75-13,75			
			v_c	f	a	v_c	f	a	
K	K1.1	Cast iron with lamellar graphite (grey cast iron), EN-GJL	< 300 N/mm ²	200	1,00	0,20	200	1,60	0,20
	K2.1	Cast iron with spheroidal graphite, EN-GJS	< 500 N/mm ²						
	K2.2	Cast iron with spheroidal graphite, EN-GJS	500-800 N/mm ²						
	K2.3	Cast iron with spheroidal graphite, EN-GJS	> 800 N/mm ²						
	K3.1	Cast iron with vermicular graphite, EN-GJV; Malleable cast iron, GJM	< 500 N/mm ²						
	K3.2	Cast iron with vermicular graphite, EN-GJV; Malleable cast iron, GJM	> 500 N/mm ²						

VR 01 I 040372

Cutting material: cermet, uncoated

ZG*	Material	Strength/Hardness [N/mm ²] [HRC]	Cutting data for ϕ [mm]						
			9,76-11,75			> 11,75-13,75			
			v_c	f	a	v_c	f	a	
K	K1.1	Cast iron with lamellar graphite (grey cast iron), EN-GJL	< 300 N/mm ²						
	K2.1	Cast iron with spheroidal graphite, EN-GJS	< 500 N/mm ²	100	1,00	0,10	100	1,30	0,20
	K2.2	Cast iron with spheroidal graphite, EN-GJS	500-800 N/mm ²	90	1,00	0,10	90	1,30	0,20
	K2.3	Cast iron with spheroidal graphite, EN-GJS	> 800 N/mm ²	80	1,00	0,10	80	1,30	0,20
	K3.1	Cast iron with vermicular graphite, EN-GJV; Malleable cast iron, GJM	< 500 N/mm ²						
	K3.2	Cast iron with vermicular graphite, EN-GJV; Malleable cast iron, GJM	> 500 N/mm ²						

VR 01 I 040370

Cutting material: carbide, uncoated

ZG*	Material	Strength/Hardness [N/mm ²] [HRC]	Cutting data for ϕ [mm]						
			9,76-11,75			> 11,75-13,75			
			v_c	f	a	v_c	f	a	
N1	N1.1	Aluminium, non-alloyed and alloyed <3% Si							
	N1.2	Aluminium, alloyed <=7% Si							
	N1.3	Aluminium, alloyed > 7-12% Si							
	N1.4	Aluminium, alloyed > 12% Si							
N2	N2.1	Copper, non-alloyed and low alloyed	< 300 N/mm ²	60	0,30	0,10	60	0,40	0,20
	N2.2	Copper, alloyed	> 300 N/mm ²	60	0,30	0,10	60	0,40	0,20
	N2.3	Brass, bronze, gun metal	< 1200 N/mm ²	60	0,30	0,10	60	0,40	0,20
N3	N3.1	Graphite							
N4	N4.1	Plastic, thermoplastic							
	N4.2	Plastic, thermosetting plastic (duroplast)							
	N4.3	Plastic, foam							

	Cutting data for \varnothing [mm]														
	> 13,75-17,75			> 17,75-21,75			> 21,75-24,75			> 24,75-31,75			> 31,75-40,25		
	v_c	f	a	v_c	f	a	v_c	f	a	v_c	f	a	v_c	f	a
	200	2,00	0,20	200	2,40	0,20	200	2,80	0,20	200	3,20	0,20	200	3,60	0,20

	Cutting data for \varnothing [mm]														
	> 13,75-17,75			> 17,75-21,75			> 21,75-24,75			> 24,75-31,75			> 31,75-40,25		
	v_c	f	a	v_c	f	a	v_c	f	a	v_c	f	a	v_c	f	a
	100	1,50	0,20	100	1,80	0,20	100	2,10	0,20	100	2,40	0,20	100	2,70	2,00
	90	1,50	0,20	90	1,80	0,20	90	2,10	0,20	90	2,40	0,20	90	2,70	2,00
	80	1,50	0,20	80	1,80	0,20	80	2,10	0,20	80	2,40	0,20	80	2,70	2,00

	Cutting data for \varnothing [mm]														
	> 13,75-17,75			> 17,75-21,75			> 21,75-24,75			> 24,75-31,75			> 31,75-40,25		
	v_c	f	a	v_c	f	a	v_c	f	a	v_c	f	a	v_c	f	a
	60	0,50	0,20	60	0,60	0,20	60	0,70	0,20	60	0,80	0,20	60	0,80	0,20
	60	0,50	0,20	60	0,60	0,20	60	0,70	0,20	60	0,80	0,20	60	0,80	0,20
	60	0,50	0,20	60	0,60	0,20	60	0,70	0,20	60	0,80	0,20	60	0,80	0,20

Parameters:

The recommended parameters are reference values.

These can be adapted depending on the application environment (machine, fixture).

Cutting data for VR reamers

Feed f [mm/rev], cutting speed v_c [m/min] and allowance a [mm]

VR 01 | 040374

Cutting material: PCD

ZG*	Material	Strength/Hardness [N/mm ²] [HRC]	Cutting data for \varnothing [mm]					
			9,76-11,75			> 11,75-13,75		
			v_c	f	a	v_c	f	a
N1	N1.1	Aluminium, non-alloyed and alloyed <3% Si	250	1,60	0,20	250	2,00	0,20
	N1.2	Aluminium, alloyed <=7% Si	250	1,60	0,20	250	2,00	0,20
	N1.3	Aluminium, alloyed > 7-12% Si	250	1,60	0,20	250	2,00	0,20
	N1.4	Aluminium, alloyed > 12% Si	250	1,60	0,20	250	2,00	0,20
N2	N2.1	Copper, non-alloyed and low alloyed	< 300 N/mm ²					
	N2.2	Copper, alloyed	> 300 N/mm ²					
	N2.3	Brass, bronze, gun metal	< 1200 N/mm ²					
N3	N3.1	Graphite						
N4	N4.1	Plastic, thermoplastic						
	N4.2	Plastic, thermosetting plastic (duroplast)						
	N4.3	Plastic, foam						

VR 01 | 040376

Cutting material: CBN

ZG*	Material	Strength/Hardness [N/mm ²] [HRC]	Cutting data for \varnothing [mm]							
			9,76-11,75			> 11,75-13,75				
			v_c	f	a	v_c	f	a		
H	H1	H1.1	Hardened steel/cast steel	45-55 HRC	80	0,10	0,10	80	0,16	0,10
		H1.2	Hardened steel/cast steel	55-64 HRC						
		H1.3	Hardened steel/cast steel	64-70 HRC						
	H2	N2.3	Wear resistant castings/chilled cast iron, GJN							

Cutting data for ϕ [mm]															
> 13,75-17,75			> 17,75-21,75			> 21,75-24,75			> 24,75-31,75			> 31,75-40,25			
v_c	f	a	v_c	f	a	v_c	f	a	v_c	f	a	v_c	f	a	
250	2,20	0,20	250	2,50	0,20	250	3,00	0,20	250	3,20	0,20	250	3,50	0,20	
250	2,20	0,20	250	2,50	0,20	250	3,00	0,20	250	3,20	0,20	250	3,50	0,20	
250	2,20	0,20	250	2,50	0,20	250	3,00	0,20	250	3,20	0,20	250	3,50	0,20	
250	2,20	0,20	250	2,50	0,20	250	3,00	0,20	250	3,20	0,20	250	3,50	0,20	

Cutting data for ϕ [mm]															
> 13,75-17,75			> 17,75-21,75			> 21,75-24,75			> 24,75-31,75			> 31,75-40,25			
v_c	f	a	v_c	f	a	v_c	f	a	v_c	f	a	v_c	f	a	
80	0,20	0,10	80	0,24	0,10	80	0,28	0,10	80	0,32	0,10	80	0,36	0,10	

Parameters:
 The recommended parameters are reference values.
 These can be adapted depending on the application environment (machine, fixture).

Cutting data for XR replaceable head reamers

Feed f [mm/rev], cutting speed vc [m/min] and allowance a [mm]

XR 06 | 081631 - Cutting material: solid carbide, BSP coated

XR 06 | 081661 - Cutting material: solid carbide, BSP coated

ZG*	Material	Strength/Hardness [N/mm ²] [HRC]	
P	P1.1 Structural, free-cutting, case hardened and heat-treated steel, non-alloyed	< 700 N/mm ²	
	P1.2 Structural, free-cutting, case hardened and heat-treated steel, non-alloyed	< 1200 N/mm ²	
	P2.1 Nitrated, case hardened and heat-treated steel, alloyed	< 900 N/mm ²	
	P2.2 Nitrated, case hardened and heat-treated steel, alloyed	< 1400 N/mm ²	
	P3.1 Tool, roller bearing, spring and high speed steel	< 900 N/mm ²	
	P3.2 Tool, roller bearing, spring and high speed steel	< 1500 N/mm ²	
	P4.1 Stainless steel, ferritic and martensitic		
	P5.1 Cast steel		
	P6.1 Stainless cast steel, ferritic and martensitic		
	K	K1.1 Cast iron with lamellar graphite (grey cast iron), EN-GJL	< 300 N/mm ²
		K2.1 Cast iron with spheroidal graphite, EN-GJS	< 500 N/mm ²
		K2.2 Cast iron with spheroidal graphite, EN-GJS	500-800 N/mm ²
K2.3 Cast iron with spheroidal graphite, EN-GJS		> 800 N/mm ²	
K3.1 Cast iron with vermicular graphite, EN-GJV; Malleable cast iron, GJM		< 500 N/mm ²	
K3.2 Cast iron with vermicular graphite, EN-GJV; Malleable cast iron, GJM		> 500 N/mm ²	

XR 01 | 081605 - Cutting material: PCD

XR 01 | 081655 - Cutting material: PCD

ZG*	Material	Strength/Hardness [N/mm ²] [HRC]
N	N1.1 Aluminium, non-alloyed and alloyed <3% Si	
	N1.2 Aluminium, alloyed <=7% Si	
	N1.3 Aluminium, alloyed > 7-12% Si	
	N1.4 Aluminium, alloyed > 12% Si	
	N2.1 Copper, non-alloyed and low alloyed	< 300 N/mm ²
	N2.2 Copper, alloyed	> 300 N/mm ²
	N2.3 Brass, bronze, gun metal	< 1200 N/mm ²
	N3.1 Graphite	
	N4.1 Plastic, thermoplastic	
	N4.2 Plastic, thermosetting plastic (duroplast)	
	N4.3 Plastic, foam	

XR 01 | 081610 - Cutting material: carbide, uncoated

XR 01 | 081650 - Cutting material: carbide, uncoated

ZG*	Material	Strength/Hardness [N/mm ²] [HRC]
N	N1.1 Aluminium, non-alloyed and alloyed <3% Si	
	N1.2 Aluminium, alloyed <=7% Si	
	N1.3 Aluminium, alloyed > 7-12% Si	
	N1.4 Aluminium, alloyed > 12% Si	
	N2.1 Copper, non-alloyed and low alloyed	< 300 N/mm ²
	N2.2 Copper, alloyed	> 300 N/mm ²
	N2.3 Brass, bronze, gun metal	< 1200 N/mm ²
	N3.1 Graphite	
	N4.1 Plastic, thermoplastic	
	N4.2 Plastic, thermosetting plastic (duroplast)	
	N4.3 Plastic, foam	

XR 01 | 081618 - Cutting material: carbide, BSP coated

XR 01 | 081651 - Cutting material: carbide, BSP coated

Cutting data for ϕ [mm]												
8-12			12-16			16-30			30-40			
v_c	f	a	v_c	f	a	v_c	f	a	v_c	f	a	
160	0,70	0,20	160	1,00	0,20	160	1,50	0,30	160	2,00	0,30	
160	0,70	0,20	160	1,00	0,20	160	1,50	0,30	160	2,00	0,30	
160	0,70	0,20	160	1,00	0,20	160	1,50	0,30	160	2,00	0,30	
160	0,70	0,20	160	1,00	0,20	160	1,50	0,30	160	2,00	0,30	
160	0,70	0,20	160	1,00	0,20	160	1,50	0,30	160	2,00	0,30	
160	0,70	0,20	160	1,00	0,20	160	1,50	0,30	160	2,00	0,30	
80	0,50	0,20	80	0,80	0,20	80	1,50	0,30	80	1,50	0,30	
120	0,60	0,10	120	0,60	0,10	120	1,20	0,15	120	1,60	0,15	
120	0,60	0,10	120	0,60	0,10	120	1,20	0,15	120	1,60	0,15	
100	0,40	0,10	100	0,60	0,10	100	1,20	0,15	100	1,60	0,15	
100	0,40	0,10	100	0,60	0,10	100	1,20	0,15	100	1,60	0,15	
100	0,40	0,10	100	0,60	0,10	100	1,20	0,15	100	1,60	0,15	
100	0,40	0,10	100	0,60	0,10	100	1,20	0,15	100	1,60	0,15	

Cutting data for ϕ [mm]									
8-14,59			14,6-29,99			30-40,2			
v_c	f	a	v_c	f	a	v_c	f	a	
200	0,60	0,10	200	1,50	0,15	200	2,00	0,15	
200	0,60	0,10	200	1,50	0,15	200	2,00	0,15	
200	0,60	0,10	200	1,50	0,15	200	2,00	0,15	
200	0,60	0,10	200	1,50	0,15	200	2,00	0,15	

Cutting data for ϕ [mm]												
8-12			12-16			16-30			30-40,2			
v_c	f	a	v_c	f	a	v_c	f	a	v_c	f	a	
30	0,60	0,20	30	0,40	0,30	30	0,50	0,30	30	0,60	0,30	
30	0,60	0,20	30	0,40	0,30	30	0,50	0,30	30	0,60	0,30	
30	0,60	0,20	30	0,40	0,30	30	0,50	0,30	30	0,60	0,30	
30	0,60	0,20	30	0,40	0,30	30	0,50	0,30	30	0,60	0,30	
30	0,60	0,20	30	0,40	0,30	30	0,50	0,30	30	0,60	0,30	
30	0,60	0,20	30	0,40	0,30	30	0,50	0,30	30	0,60	0,30	
30	0,60	0,20	30	0,40	0,30	30	0,50	0,30	30	0,60	0,30	

Parameters: The recommended parameters are reference values. These can be adapted depending on the application environment (machine, fixture).

Cutting data for XR replaceable head reamers

Feed f [mm/rev], cutting speed v_c [m/min] and allowance a [mm]

XR 01 | 081612

Cutting material: Cermet, uncoated

XR 01 | 081652

Cutting material: Cermet, uncoated

ZG*		Material	Strength/Hardness [N/mm ²] [HRC]	
P	P1	P1.1 Structural, free-cutting, case hardened and heat-treated steel, non-alloyed	< 700 N/mm ²	
		P1.2 Structural, free-cutting, case hardened and heat-treated steel, non-alloyed	< 1200 N/mm ²	
	P2	P2.1 Nitrated, case hardened and heat-treated steel, alloyed	< 900 N/mm ²	
		P2.2 Nitrated, case hardened and heat-treated steel, alloyed	< 1400 N/mm ²	
	P3	P3.1 Tool, roller bearing, spring and high speed steel	< 900 N/mm ²	
		P3.2 Tool, roller bearing, spring and high speed steel	< 1500 N/mm ²	
	P4	P4.1 Stainless steel, ferritic and martensitic		
	P5	P5.1 Cast steel		
	P6	P6.1 Stainless cast steel, ferritic and martensitic		
	K	K1	K1.1 Cast iron with lamellar graphite (grey cast iron), EN-GJL	< 300 N/mm ²
			K2.1 Cast iron with spheroidal graphite, EN-GJS	< 500 N/mm ²
		K2	K2.2 Cast iron with spheroidal graphite, EN-GJS	500-800 N/mm ²
K2.3 Cast iron with spheroidal graphite, EN-GJS			> 800 N/mm ²	
K3		K3.1 Cast iron with vermicular graphite, EN-GJV; Malleable cast iron, GJM	< 500 N/mm ²	
		K3.2 Cast iron with vermicular graphite, EN-GJV; Malleable cast iron, GJM	> 500 N/mm ²	

XR 01 | 081611

Cutting material: carbide, BVA coated

XR 01 | 081659

Cutting material: carbide, BVA coated

ZG*		Material	Strength/Hardness [N/mm ²] [HRC]	
P	P1	P1.1 Structural, free-cutting, case hardened and heat-treated steel, non-alloyed	< 700 N/mm ²	
		P1.2 Structural, free-cutting, case hardened and heat-treated steel, non-alloyed	< 1200 N/mm ²	
	P2	P2.1 Nitrated, case hardened and heat-treated steel, alloyed	< 900 N/mm ²	
		P2.2 Nitrated, case hardened and heat-treated steel, alloyed	< 1400 N/mm ²	
	P3	P3.1 Tool, roller bearing, spring and high speed steel	< 900 N/mm ²	
		P3.2 Tool, roller bearing, spring and high speed steel	< 1500 N/mm ²	
	P4	P4.1 Stainless steel, ferritic and martensitic		
	P5	P5.1 Cast steel		
	P6	P6.1 Stainless cast steel, ferritic and martensitic		
	M	M1	M1.1 Stainless steel, austenitic	< 700 N/mm ²
			M1.2 Stainless steel, ferritic/austenitic (Duplex)	< 1000 N/mm ²
		M2	M2.1 Stainless cast steel, austenitic	< 700 N/mm ²
M3		M3.1 Stainless cast steel, ferritic/austenitic (Duplex)	< 1000 N/mm ²	

Cutting data for \varnothing [mm]												
8-9,7			9,7-16			16-30			30-40			
v_c	f	a	v_c	f	a	v_c	f	a	v_c	f	a	
140	0,60	0,20	140	0,80	0,20	140	1,00	0,20	140	1,40	0,30	
90	0,60	0,20	90	0,80	0,20	90	1,00	0,20	90	1,40	0,30	
140	0,60	0,20	140	0,80	0,20	140	1,00	0,20	140	1,40	0,30	
90	0,60	0,20	90	0,80	0,20	90	1,00	0,20	90	1,40	0,30	
120	0,60	0,20	120	0,80	0,20	120	1,00	0,20	120	1,40	0,30	
90	0,60	0,20	90	0,80	0,20	90	1,00	0,20	90	1,40	0,30	
90	0,60	0,20	90	0,80	0,20	90	1,00	0,20	90	1,40	0,30	
120	0,70	0,20	120	1,20	0,20	120	1,60	0,20	120	2,00	0,30	
90	0,70	0,20	90	1,20	0,20	90	1,60	0,20	90	2,00	0,30	
90	0,70	0,20	90	1,20	0,20	90	1,60	0,20	90	2,00	0,30	
90	0,70	0,20	90	1,20	0,20	90	1,60	0,20	90	2,00	0,30	
90	0,70	0,20	90	1,20	0,20	90	1,60	0,20	90	2,00	0,30	

Cutting data for \varnothing [mm]												
8-9,7			9,7-16			16-30			30-40			
v_c	f	a	v_c	f	a	v_c	f	a	v_c	f	a	
40	0,30	0,10	40	0,40	0,20	40	0,50	0,20	40	1,20	0,30	
40	0,30	0,10	40	0,40	0,20	40	0,50	0,20	40	1,20	0,30	
40	0,30	0,10	40	0,40	0,20	40	0,50	0,20	40	1,20	0,30	
30	0,30	0,10	30	0,40	0,20	30	0,50	0,20	30	1,20	0,30	
40	0,30	0,10	40	0,40	0,20	40	0,50	0,20	40	1,20	0,30	
30	0,30	0,10	30	0,40	0,20	30	0,50	0,20	30	1,20	0,30	

Parameters:

The recommended parameters are reference values.

These can be adapted depending on the application environment (machine, fixture).

Cutting data for cutting rings MultiCut

Feed f_z [mm], cutting speed v_c [m/min] for high-speed cutting

Material	Min. tensile strength N/mm ²	Cutting ring			Cutting material					
		Lead			Carbide		TiN		Cermet	
		20°	25°	45°	v_c	f_z	v_c	f_z	v_c	f_z
Non-alloy steel	< 500	■		■			120	0,08-0,17	120-200	0,05-0,18
Non-alloy/low alloy steel	500-900	■		■			120	0,08-0,17	100-150	0,05-0,18
Lead-alloy free-cutting steel		■		■			120	0,08-0,17	100-180	0,05-0,18
Non-alloy/low alloy steel	> 900	■		■			80	0,08-0,14	80-120	0,05-0,18
High-alloy steel				■			30	0,06-0,12		
HSS				■			20	0,06-0,12		
Special alloys				■			30	0,06-0,12		
Stainless steel	< 600			■			30	0,06-0,12		
Stainless steel	> 600			■			20	0,06-0,12		
Stainless, heat-resistant steel	> 750			■			20	0,06-0,12		
Cast iron				■			75	0,11-0,19		
Cast iron alloy				■			50	0,11-0,19		
Spheroidal graphite cast iron, ferritic, malleable	< 600			■			150	0,11-0,19	100-180	0,08-0,2
Spheroidal graphite cast iron, perlitic, malleable	> 600			■			100	0,11-0,19	120	0,11-0,19
Spheroidal graphite cast iron alloy				■			45	0,11-0,19		
Titanium, titanium alloy										
Copper alloys, brass, lead-alloy bronze, leaded bronze with good cutting properties				■	150	0,15-0,25	120	0,1-0,18	200	0,1-0,18
Copper alloys, brass, bronze with medium cutting properties				■			100	0,1-0,18	150	0,1-0,18
Copper, copper alloys, aluminium, manganese and phosphor bronze, difficult cutting properties				■			60	0,1-0,18		
Wrought aluminium alloy, magnesium alloy										
Cast aluminium alloy, Si-content < 10 %					350	0,15-0,25				
Cast aluminium alloy, Si-content > 10 %					350	0,15-0,25				0,12-0,20
Plastics										
Fibreglass reinforced plastics				■			40	0,12-0,20		

Cutting data for cutting rings MultiCut

Feed f_z [mm], cutting speed v_c [m/min] for standard cutting

Material	Min. tensile strength N/mm ²	Cutting ring				Cutting material	
		Lead				Carbide	
		30°/2°	30°/4°	45(30)°	45°/8°	v_c	f_z
Non-alloy steel	< 500			■		8	0,08-0,13
Non-alloy/low alloy steel	500-900				■	8	0,08-0,15
Lead-alloy free-cutting steel				■		30	0,08-0,13
Non-alloy/low alloy steel	> 900			■		7	0,05-0,10
High-alloy steel				■		5	0,05-0,08
HSS				■		4	0,05-0,08
Special alloys				■		5	0,05-0,08
Stainless steel	< 600			■		6	0,05-0,08
Stainless steel	> 600			■		5	0,05-0,08
Stainless, heat-resistant steel	> 750			■		5	0,05-0,08
Cast iron				■		15	0,09-0,13
Cast iron alloy				■		8	0,09-0,13
Spheroidal graphite cast iron, ferritic, malleable	< 600				■	12	0,08-0,17
Spheroidal graphite cast iron, perlitic, malleable	> 600			■		10	0,09-0,13
Spheroidal graphite cast iron alloy				■		8	0,09-0,13
Titanium, titanium alloy		■		■		10	0,1-0,18
Copper alloys, brass, lead-alloy bronze, leaded bronze with good cutting properties				■		20	0,08-0,13
Copper alloys, brass, bronze with medium cutting properties				■		15	0,08-0,13
Copper, copper alloys, aluminium, manganese and phosphor bronze, difficult cutting properties						12	0,08-0,13
Wrought aluminium alloy, magnesium alloy					■	10	0,08-0,15
Cast aluminium alloy, Si-content < 10 %					■	10	0,08-0,15
Cast aluminium alloy, Si-content > 10 %				■		12	0,08-0,13
Plastics						20	0,1-0,18
Fibreglass reinforced plastics				■		8	0,09-0,15

Parameters:

The recommended parameters are reference values.

These can be adapted depending on the application environment (machine, fixture).

Cutting data for NC machine reamers, machine reamers and shell

Cutting material: carbide, uncoated, without internal coolant supply

Feed f [mm/rev], cutting speed vc [m/min] and allowance a [mm]

ZG*	Material	Strength/Hardness [N/mm ²] [HRC]	
P	P1.1 Structural, free-cutting, case hardened and heat-treated steel, non-alloyed	< 700 N/mm ²	
	P1.2 Structural, free-cutting, case hardened and heat-treated steel, non-alloyed	< 1200 N/mm ²	
	P2.1 Nitrated, case hardened and heat-treated steel, alloyed	< 900 N/mm ²	
	P2.2 Nitrated, case hardened and heat-treated steel, alloyed	< 1400 N/mm ²	
	P3.1 Tool, roller bearing, spring and high speed steel	< 900 N/mm ²	
	P3.2 Tool, roller bearing, spring and high speed steel	< 1500 N/mm ²	
	P4.1 Stainless steel, ferritic and martensitic		
	P5.1 Cast steel		
	P6.1 Stainless cast steel, ferritic and martensitic		
	K	K1.1 Cast iron with lamellar graphite (grey cast iron), EN-GJL	< 300 N/mm ²
		K2.1 Cast iron with spheroidal graphite, EN-GJS	< 500 N/mm ²
		K2.2 Cast iron with spheroidal graphite, EN-GJS	500-800 N/mm ²
K2.3 Cast iron with spheroidal graphite, EN-GJS		> 800 N/mm ²	
K3.1 Cast iron with vermicular graphite, EN-GJV; Malleable cast iron, GJM		< 500 N/mm ²	
K3.2 Cast iron with vermicular graphite, EN-GJV; Malleable cast iron, GJM		> 500 N/mm ²	
N	N1.1 Aluminium, non-alloyed and alloyed <3% Si		
	N1.2 Aluminium, alloyed <=7% Si		
	N1.3 Aluminium, alloyed > 7-12% Si		
	N1.4 Aluminium, alloyed > 12% Si		
	N2.1 Copper, non-alloyed and low alloyed	< 300 N/mm ²	
	N2.2 Copper, alloyed	> 300 N/mm ²	
	N2.3 Brass, bronze, gun metal	< 1200 N/mm ²	
	N3.1 Graphite		
	N4.1 Plastic, thermoplastic		
	N4.2 Plastic, thermosetting plastic (duroplast)		
N4.3 Plastic, foam			

reamers

	<5 [mm]			>5 - 8 [mm]			>8 - 12 [mm]			>12 - 16 [mm]			>16 - 30 [mm]			>30 - 50 [mm]		
	v _c	f	a	v _c	f	a	v _c	f	a	v _c	f	a	v _c	f	a	v _c	f	a
	20	0,10	0,10	20	0,15	0,15	20	0,20	0,20	20	0,25	0,20	20	0,30	0,30	20	0,40	0,30
	12	0,10	0,10	12	0,15	0,15	12	0,20	0,20	12	0,25	0,20	12	0,30	0,30	12	0,40	0,30
	15	0,10	0,10	15	0,15	0,15	15	0,20	0,20	15	0,25	0,20	15	0,30	0,30	15	0,40	0,30
	12	0,10	0,10	12	0,15	0,15	12	0,20	0,20	12	0,25	0,20	12	0,30	0,30	12	0,40	0,30
	15	0,10	0,10	15	0,15	0,15	15	0,20	0,20	15	0,25	0,20	15	0,30	0,30	15	0,40	0,30
	12	0,10	0,10	12	0,15	0,15	12	0,20	0,20	12	0,25	0,20	12	0,30	0,30	12	0,40	0,30
	15	0,10	0,10	15	0,15	0,15	15	0,20	0,20	15	0,25	0,20	15	0,30	0,30	15	0,40	0,30
	18	0,10	0,10	18	0,20	0,15	18	0,30	0,20	18	0,30	0,20	18	0,40	0,30	18	0,50	0,30
	15	0,10	0,10	15	0,20	0,15	15	0,30	0,20	15	0,30	0,20	15	0,40	0,30	15	0,50	0,30
	10	0,10	0,10	10	0,20	0,15	10	0,30	0,20	10	0,30	0,20	10	0,40	0,30	10	0,50	0,30
	10	0,10	0,10	10	0,20	0,15	10	0,30	0,20	10	0,30	0,20	10	0,40	0,30	10	0,50	0,30
	15	0,10	0,10	15	0,20	0,15	15	0,30	0,20	15	0,30	0,20	15	0,40	0,30	15	0,50	0,30
	10	0,10	0,10	10	0,20	0,15	10	0,30	0,20	10	0,30	0,20	10	0,40	0,30	10	0,50	0,30
	40	0,15	0,10	40	0,20	0,15	40	0,25	0,20	40	0,30	0,20	40	0,40	0,30	40	0,50	0,30
	25	0,15	0,10	25	0,20	0,15	25	0,25	0,20	25	0,30	0,20	25	0,40	0,30	25	0,50	0,30
	30	0,15	0,10	30	0,20	0,15	30	0,25	0,20	30	0,30	0,20	30	0,40	0,30	30	0,50	0,30
	30	0,15	0,10	30	0,20	0,15	30	0,25	0,20	30	0,30	0,20	30	0,40	0,30	30	0,50	0,30
	30	0,15	0,10	30	0,20	0,15	30	0,25	0,20	30	0,30	0,20	30	0,40	0,30	30	0,50	0,30
	40	0,15	0,10	40	0,20	0,15	40	0,25	0,20	40	0,30	0,20	40	0,40	0,30	40	0,50	0,30
	40	0,15	0,10	40	0,20	0,15	40	0,25	0,20	40	0,30	0,20	40	0,40	0,30	40	0,50	0,30
	40	0,15	0,10	40	0,20	0,15	40	0,25	0,20	40	0,30	0,20	40	0,40	0,30	40	0,50	0,30

Parameters:

The recommended parameters are reference values.

These can be adapted depending on the application environment (machine, fixture).

Cutting data for NC machine reamers

Cutting material: carbide, TiAlN coated, without internal coolant supply

Feed f [mm/rev], cutting speed v_c [m/min] and allowance a [mm]

ZG*		Material	Strength/Hardness [N/mm ²] [HRC]
P	P1	P1.1 Structural, free-cutting, case hardened and heat-treated steel, non-alloyed	< 700 N/mm ²
		P1.2 Structural, free-cutting, case hardened and heat-treated steel, non-alloyed	< 1200 N/mm ²
	P2	P2.1 Nitrated, case hardened and heat-treated steel, alloyed	< 900 N/mm ²
		P2.2 Nitrated, case hardened and heat-treated steel, alloyed	< 1400 N/mm ²
	P3	P3.1 Tool, roller bearing, spring and high speed steel	< 900 N/mm ²
		P3.2 Tool, roller bearing, spring and high speed steel	< 1500 N/mm ²
	P4	P4.1 Stainless steel, ferritic and martensitic	
	P5	P5.1 Cast steel	
	P6	P6.1 Stainless cast steel, ferritic and martensitic	
	M	M1	M1.1 Stainless steel, austenitic
M1.2 Stainless steel, ferritic/austenitic (Duplex)			< 1000 N/mm ²
M2		M2.1 Stainless cast steel, austenitic	< 700 N/mm ²
M3		M3.1 Stainless cast steel, ferritic/austenitic (Duplex)	< 1000 N/mm ²
K	K1	K1.1 Cast iron with lamellar graphite (grey cast iron), EN-GJL	< 300 N/mm ²
		K2.1 Cast iron with spheroidal graphite, EN-GJS	< 500 N/mm ²
	K2	K2.2 Cast iron with spheroidal graphite, EN-GJS	500-800 N/mm ²
		K2.3 Cast iron with spheroidal graphite, EN-GJS	> 800 N/mm ²
	K3	K3.1 Cast iron with vermicular graphite, EN-GJV; Malleable cast iron, GJM	< 500 N/mm ²
		K3.2 Cast iron with vermicular graphite, EN-GJV; Malleable cast iron, GJM	> 500 N/mm ²
S	S1	S1.1 Titanium, titanium alloy	< 400 N/mm ²
		S2.1 Titanium, titanium alloy	< 1200 N/mm ²
	S2	S2.2 Titanium, titanium alloy	> 1200 N/mm ²
		S3.1 Nickel, non-alloyed and alloyed	< 900 N/mm ²
	S3	S3.2 Nickel, non-alloyed and alloyed	> 900 N/mm ²
		S4	S4.1 Heat resistant super alloys, Ni, Co, and Fe based
	S5	S5.1 Tungsten and molybdenum alloys	
H	H1	H1.1 Hardened steel/cast steel	45-55 HRC
		H1.2 Hardened steel/cast steel	55-64 HRC
		H1.3 Hardened steel/cast steel	64-70 HRC
	H2	H2.3 Wear resistant castings/chilled cast iron, GJN	

	<5 [mm]			>5 - 8 [mm]			>8 - 12 [mm]			>12 - 16 [mm]			>16 - 30 [mm]			>30 - 50 [mm]		
	v _c	f	a	v _c	f	a	v _c	f	a	v _c	f	a	v _c	f	a	v _c	f	a
	30	0,10	0,10	30	0,15	0,10	30	0,20	0,20	30	0,25	0,20	30	0,30	0,30	30	0,40	0,30
	15	0,10	0,10	15	0,15	0,10	15	0,20	0,20	15	0,25	0,20	15	0,30	0,30	15	0,40	0,30
	25	0,10	0,10	25	0,15	0,10	25	0,20	0,20	25	0,25	0,20	25	0,30	0,30	25	0,40	0,30
	15	0,10	0,10	15	0,15	0,10	15	0,20	0,20	15	0,25	0,20	15	0,30	0,30	15	0,40	0,30
	25	0,10	0,10	25	0,15	0,10	25	0,20	0,20	25	0,25	0,20	25	0,30	0,30	25	0,40	0,30
	15	0,10	0,10	15	0,15	0,10	15	0,20	0,20	15	0,25	0,20	15	0,30	0,30	15	0,40	0,30
	25	0,10	0,10	25	0,15	0,10	25	0,20	0,20	25	0,25	0,20	25	0,30	0,30	25	0,40	0,30
	15	0,08	0,08	15	0,10	0,10	15	0,15	0,10	15	0,20	0,20	15	0,25	0,20	15	0,30	0,30
	10	0,08	0,08	10	0,10	0,10	10	0,15	0,10	10	0,20	0,20	10	0,25	0,20	10	0,30	0,30
	15	0,08	0,08	15	0,10	0,10	15	0,15	0,10	15	0,20	0,20	15	0,25	0,20	15	0,30	0,30
	10	0,08	0,08	10	0,10	0,10	10	0,15	0,10	10	0,20	0,20	10	0,25	0,20	10	0,30	0,30
	30	0,10	0,10	30	0,20	0,10	30	0,30	0,20	30	0,30	0,20	30	0,40	0,30	30	0,50	0,30
	25	0,10	0,10	25	0,20	0,10	25	0,30	0,20	25	0,30	0,20	25	0,40	0,30	25	0,50	0,30
	20	0,10	0,10	20	0,20	0,10	20	0,30	0,20	20	0,30	0,20	20	0,40	0,30	20	0,50	0,30
	20	0,10	0,10	20	0,20	0,10	20	0,30	0,20	20	0,30	0,20	20	0,40	0,30	20	0,50	0,30
	25	0,10	0,10	25	0,20	0,10	25	0,30	0,20	25	0,30	0,20	25	0,40	0,30	25	0,50	0,30
	20	0,10	0,10	20	0,20	0,10	20	0,30	0,20	20	0,30	0,20	20	0,40	0,30	20	0,50	0,30
	10	0,06	0,05	10	0,10	0,10	10	0,12	0,10	10	0,18	0,15	10	0,20	0,20	10	0,25	0,20
	10	0,06	0,05	10	0,10	0,10	10	0,12	0,10	10	0,18	0,15	10	0,20	0,20	10	0,25	0,20
	10	0,06	0,05	10	0,10	0,10	10	0,12	0,10	10	0,18	0,15	10	0,20	0,20	10	0,25	0,20
	10	0,06	0,05	10	0,10	0,10	10	0,12	0,10	10	0,18	0,15	10	0,20	0,20	10	0,25	0,20
	10	0,06	0,05	10	0,10	0,10	10	0,12	0,10	10	0,18	0,15	10	0,20	0,20	10	0,25	0,20
	10	0,06	0,05	10	0,10	0,10	10	0,12	0,10	10	0,18	0,15	10	0,20	0,20	10	0,25	0,20
	8	0,05	0,05	8	0,08	0,05	8	0,10	0,10	8	0,13	0,10	8	0,15	0,15	8	0,20	0,20
	8	0,05	0,05	8	0,08	0,05	8	0,10	0,10	8	0,13	0,10	8	0,15	0,15	8	0,20	0,20
	8	0,05	0,05	8	0,08	0,05	8	0,10	0,10	8	0,13	0,10	8	0,15	0,15	8	0,20	0,20

Parameters:

The recommended parameters are reference values.
 These can be adapted depending on the application environment (machine, fixture).

Cutting data for NC machine reamers, machine reamers and shell

Cutting material: HSS-E, uncoated und HSS-E, coated, without internal coolant supply

Feed f [mm/rev], cutting speed vc [m/min] and allowance a [mm]

ZG*		Material	Strength/Hardness [N/mm ²] [HRC]	
P	P1	P1.1 Structural, free-cutting, case hardened and heat-treated steel, non-alloyed	< 700 N/mm ²	
		P1.2 Structural, free-cutting, case hardened and heat-treated steel, non-alloyed	< 1200 N/mm ²	
	P2	P2.1 Nitrated, case hardened and heat-treated steel, alloyed	< 900 N/mm ²	
		P2.2 Nitrated, case hardened and heat-treated steel, alloyed	< 1400 N/mm ²	
	P3	P3.1 Tool, roller bearing, spring and high speed steel	< 900 N/mm ²	
		P3.2 Tool, roller bearing, spring and high speed steel	< 1500 N/mm ²	
	P4	P4.1 Stainless steel, ferritic and martensitic		
	P5	P5.1 Cast steel		
	P6	P6.1 Stainless cast steel, ferritic and martensitic		
	K	K1	K1.1 Cast iron with lamellar graphite (grey cast iron), EN-GJL	< 300 N/mm ²
			K2.1 Cast iron with spheroidal graphite, EN-GJS	< 500 N/mm ²
		K2	K2.2 Cast iron with spheroidal graphite, EN-GJS	500-800 N/mm ²
K2.3 Cast iron with spheroidal graphite, EN-GJS			> 800 N/mm ²	
K3		K3.1 Cast iron with vermicular graphite, EN-GJV; Malleable cast iron, GJM	< 500 N/mm ²	
		K3.2 Cast iron with vermicular graphite, EN-GJV; Malleable cast iron, GJM	> 500 N/mm ²	
N	N1	N1.1 Aluminium, non-alloyed and alloyed <3% Si		
		N1.2 Aluminium, alloyed <=7% Si		
		N1.3 Aluminium, alloyed > 7-12% Si		
		N1.4 Aluminium, alloyed > 12% Si		
	N2	N2.1 Copper, non-alloyed and low alloyed	< 300 N/mm ²	
		N2.2 Copper, alloyed	> 300 N/mm ²	
		N2.3 Brass, bronze, gun metal	< 1200 N/mm ²	
	N3	N3.1 Graphite		
	N4	N4.1 Plastic, thermoplastic		
		N4.2 Plastic, thermosetting plastic (duroplast)		
		N4.3 Plastic, foam		

reamers

	<5 [mm]			>5 - 8 [mm]			>8 - 12 [mm]			>12 - 16 [mm]			>16 - 30 [mm]			>30 - 50 [mm]		
	v _c	f	a	v _c	f	a	v _c	f	a	v _c	f	a	v _c	f	a	v _c	f	a
	12	0,10	0,10	12	0,15	0,15	12	0,20	0,20	12	0,25	0,20	12	0,30	0,30	12	0,40	0,30
	10	0,10	0,10	10	0,15	0,15	10	0,20	0,20	10	0,25	0,20	10	0,30	0,30	10	0,40	0,30
	12	0,10	0,10	12	0,15	0,15	12	0,20	0,20	12	0,25	0,20	12	0,30	0,30	12	0,40	0,30
	10	0,10	0,10	10	0,15	0,15	10	0,20	0,20	10	0,25	0,20	10	0,30	0,30	10	0,40	0,30
	12	0,10	0,10	12	0,15	0,15	12	0,20	0,20	12	0,25	0,20	12	0,30	0,30	12	0,40	0,30
	10	0,10	0,10	10	0,15	0,15	10	0,20	0,20	10	0,25	0,20	10	0,30	0,30	10	0,40	0,30
	12	0,15	0,10	12	0,20	0,15	12	0,25	0,20	12	0,30	0,20	12	0,35	0,30	12	0,40	0,30
	10	0,15	0,10	10	0,20	0,15	10	0,25	0,20	10	0,30	0,20	10	0,35	0,30	10	0,40	0,30
	10	0,15	0,10	10	0,20	0,15	10	0,25	0,20	10	0,30	0,20	10	0,35	0,30	10	0,40	0,30
	10	0,15	0,10	10	0,20	0,15	10	0,25	0,20	10	0,30	0,20	10	0,35	0,30	10	0,40	0,30
	10	0,15	0,10	10	0,20	0,15	10	0,25	0,20	10	0,30	0,20	10	0,35	0,30	10	0,40	0,30
	15	0,15	0,10	15	0,20	0,15	15	0,20	0,20	15	0,25	0,20	15	0,30	0,30	15	0,40	0,30
	20	0,15	0,10	20	0,20	0,15	20	0,20	0,20	20	0,25	0,20	20	0,30	0,30	20	0,40	0,30
	20	0,15	0,10	20	0,20	0,15	20	0,20	0,20	20	0,25	0,20	20	0,30	0,30	20	0,40	0,30
	20	0,15	0,10	20	0,20	0,15	20	0,20	0,20	20	0,25	0,20	20	0,30	0,30	20	0,40	0,30
	25	0,15	0,10	25	0,20	0,15	25	0,20	0,20	25	0,25	0,20	25	0,30	0,30	25	0,40	0,30
	25	0,15	0,10	25	0,20	0,15	25	0,20	0,20	25	0,25	0,20	25	0,30	0,30	25	0,40	0,30
	25	0,15	0,10	25	0,20	0,15	25	0,20	0,20	25	0,25	0,20	25	0,30	0,30	25	0,40	0,30

Parameters:

The recommended parameters are reference values.
 These can be adapted depending on the application environment (machine, fixture).

Cutting data for countersinks EUC-Speed

Countersink extreme unequal spacing – **Cutting material: HSS coated**

Feed f [mm/rev], cutting speed vc [m/min]

ZG*		Material	Strength/Hardness [N/mm ²] [HRC]
P	P1	P1.1 Structural, free-cutting, case hardened and heat-treated steel, non-alloyed	< 700 N/mm ²
		P1.2 Structural, free-cutting, case hardened and heat-treated steel, non-alloyed	< 1200 N/mm ²
	P2	P2.1 Nitratated, case hardened and heat-treated steel, alloyed	< 900 N/mm ²
		P2.2 Nitratated, case hardened and heat-treated steel, alloyed	< 1400 N/mm ²
	P3	P3.1 Tool, roller bearing, spring and high speed steel	< 900 N/mm ²
		P3.2 Tool, roller bearing, spring and high speed steel	< 1500 N/mm ²
P4	P4.1 Stainless steel, ferritic and martensitic		
P5	P5.1 Cast steel		
P6	P6.1 Stainless cast steel, ferritic and martensitic		
M	M1	M1.1 Stainless steel, austenitic	< 700 N/mm ²
		M1.2 Stainless steel, ferritic/austenitic (Duplex)	< 1000 N/mm ²
	M2	M2.1 Stainless cast steel, austenitic	< 700 N/mm ²
		M2.2 Stainless cast steel, ferritic/austenitic (Duplex)	< 1000 N/mm ²
K	K1	K1.1 Cast iron with lamellar graphite (grey cast iron), EN-GJL	< 300 N/mm ²
		K2.1 Cast iron with spheroidal graphite, EN-GJS	< 500 N/mm ²
	K2	K2.2 Cast iron with spheroidal graphite, EN-GJS	500-800 N/mm ²
		K2.3 Cast iron with spheroidal graphite, EN-GJS	> 800 N/mm ²
	K3	K3.1 Cast iron with vermicular graphite, EN-GJV; Malleable cast iron, GJM	< 500 N/mm ²
		K3.2 Cast iron with vermicular graphite, EN-GJV; Malleable cast iron, GJM	> 500 N/mm ²
N	N1	N1.1 Aluminium, non-alloyed and alloyed <3% Si	
		N1.2 Aluminium, alloyed <=7% Si	
		N1.3 Aluminium, alloyed > 7-12% Si	
		N1.4 Aluminium, alloyed > 12% Si	
	N2	N2.1 Copper, non-alloyed and low alloyed	< 300 N/mm ²
		N2.2 Copper, alloyed	> 300 N/mm ²
		N2.3 Brass, bronze, gun metal	< 1200 N/mm ²
	N3	N3.1 Graphite	
		N4.1 Plastic, thermoplastic	
	N4	N4.2 Plastic, thermosetting plastic (duroplast)	
		N4.3 Plastic, foam	
	S	S1	S1.1 Titanium, titanium alloy
S2.1 Titanium, titanium alloy			< 1200 N/mm ²
S2		S2.2 Titanium, titanium alloy	> 1200 N/mm ²
		S3.1 Nickel, non-alloyed and alloyed	< 900 N/mm ²
S3		S3.2 Nickel, non-alloyed and alloyed	> 900 N/mm ²
		S4.1 Heat resistant super alloys, Ni, Co, and Fe based	
S5	S5.1 Tungsten and molybdenum alloys		
H	H1	H1.1 Hardened steel/cast steel	45-55 HRC
		H1.2 Hardened steel/cast steel	55-64 HRC
		H1.3 Hardened steel/cast steel	64-70 HRC
	H2	N2.3 Wear resistant castings/chilled cast iron, GJN	

	ø < 5 [mm]		ø > 5 - 8 [mm]		ø > 8 - 12,4 [mm]		ø > 12,4 - 16,5 [mm]		ø > 16,5 - 20,5 [mm]		ø > 20,5 - 25 [mm]		ø > 25 - 31 [mm]	
	v _c	f	v _c	f	v _c	f	v _c	f	v _c	f	v _c	f	v _c	f
	40	0,06	40	0,08	40	0,10	40	0,12	40	0,14	40	0,18	40	0,22
	30	0,04	30	0,06	30	0,08	30	0,10	30	0,12	30	0,14	30	0,18
	30	0,04	30	0,06	30	0,08	30	0,10	30	0,12	30	0,14	30	0,18
	12	0,03	12	0,04	12	0,05	12	0,06	12	0,08	12	0,10	12	0,12
	30	0,04	30	0,06	30	0,08	30	0,10	30	0,12	30	0,14	30	0,18
	12	0,03	12	0,04	12	0,05	12	0,06	12	0,08	12	0,10	12	0,12
	15	0,04	15	0,05	15	0,06	15	0,07	15	0,08	15	0,09	15	0,12
	30	0,04	30	0,06	30	0,08	30	0,10	30	0,12	30	0,14	30	0,18
	15	0,04	15	0,05	15	0,06	15	0,07	15	0,08	15	0,09	15	0,12
	15	0,04	15	0,05	15	0,06	15	0,07	15	0,08	15	0,09	15	0,12
	10	0,04	10	0,05	10	0,06	10	0,07	10	0,08	10	0,09	10	0,12
	15	0,04	15	0,05	15	0,06	15	0,07	15	0,08	15	0,09	15	0,12
	20	0,06	20	0,10	20	0,12	20	0,14	20	0,18	20	0,20	20	0,25
	20	0,06	20	0,10	20	0,12	20	0,14	20	0,18	20	0,20	20	0,25
	20	0,06	20	0,10	20	0,12	20	0,14	20	0,18	20	0,20	20	0,25
	20	0,06	20	0,10	20	0,12	20	0,14	20	0,18	20	0,20	20	0,25
	20	0,06	20	0,10	20	0,12	20	0,14	20	0,18	20	0,20	20	0,25
	20	0,06	20	0,10	20	0,12	20	0,14	20	0,18	20	0,20	20	0,25
	50	0,08	50	0,10	50	0,12	50	0,14	50	0,18	50	0,22	50	0,26
	50	0,08	50	0,10	50	0,12	50	0,14	50	0,18	50	0,22	50	0,26
	40	0,08	40	0,10	40	0,12	40	0,14	40	0,18	40	0,22	40	0,26
	40	0,08	40	0,10	40	0,12	40	0,14	40	0,18	40	0,22	40	0,26
	40	0,10	40	0,12	40	0,14	40	0,18	40	0,20	40	0,24	40	0,30
	40	0,10	40	0,12	40	0,14	40	0,18	40	0,20	40	0,24	40	0,30
	40	0,10	40	0,12	40	0,14	40	0,18	40	0,20	40	0,24	40	0,30
	40	0,10	40	0,12	40	0,14	40	0,18	40	0,20	40	0,24	40	0,30
	40	0,10	40	0,12	40	0,14	40	0,18	40	0,20	40	0,24	40	0,30
	40	0,10	40	0,12	40	0,14	40	0,18	40	0,20	40	0,24	40	0,30
	10	0,04	10	0,05	10	0,06	10	0,07	10	0,08	10	0,09	10	0,12
	10	0,04	10	0,05	10	0,06	10	0,07	10	0,08	10	0,09	10	0,12
	10	0,04	10	0,05	10	0,06	10	0,07	10	0,08	10	0,09	10	0,12
	10	0,04	10	0,05	10	0,06	10	0,07	10	0,08	10	0,09	10	0,12
	10	0,04	10	0,05	10	0,06	10	0,07	10	0,08	10	0,09	10	0,12
	10	0,04	10	0,05	10	0,06	10	0,07	10	0,08	10	0,09	10	0,12
	10	0,04	10	0,05	10	0,06	10	0,07	10	0,08	10	0,09	10	0,12
	6	0,04	6	0,05	6	0,06	6	0,08	6	0,08	6	0,10		

Parameters:

The recommended parameters are reference values.
 These can be adapted depending on the application environment (machine, fixture).

Next page:
 solid carbide version



Cutting data for countersinks EUC-Speed

Countersink extreme unequal spacing – **Cutting material: solid carbide coated**

Feed f [mm/rev], cutting speed vc [m/min]

ZG*		Material	Strength/Hardness [N/mm ²] [HRC]	
P	P1	P1.1 Structural, free-cutting, case hardened and heat-treated steel, non-alloyed	< 700 N/mm ²	
		P1.2 Structural, free-cutting, case hardened and heat-treated steel, non-alloyed	< 1200 N/mm ²	
	P2	P2.1 Nitrated, case hardened and heat-treated steel, alloyed	< 900 N/mm ²	
		P2.2 Nitrated, case hardened and heat-treated steel, alloyed	< 1400 N/mm ²	
	P3	P3.1 Tool, roller bearing, spring and high speed steel	< 900 N/mm ²	
		P3.2 Tool, roller bearing, spring and high speed steel	< 1500 N/mm ²	
P4	P4.1 Stainless steel, ferritic and martensitic			
P5	P5.1 Cast steel			
P6	P6.1 Stainless cast steel, ferritic and martensitic			
M	M1	M1.1 Stainless steel, austenitic	< 700 N/mm ²	
		M1.2 Stainless steel, ferritic/austenitic (Duplex)	< 1000 N/mm ²	
	M2	M2.1 Stainless cast steel, austenitic	< 700 N/mm ²	
	M3	M3.1 Stainless cast steel, ferritic/austenitic (Duplex)	< 1000 N/mm ²	
K	K1	K1.1 Cast iron with lamellar graphite (grey cast iron), EN-GJL	< 300 N/mm ²	
		K2.1 Cast iron with spheroidal graphite, EN-GJS	< 500 N/mm ²	
	K2	K2.2 Cast iron with spheroidal graphite, EN-GJS	500-800 N/mm ²	
		K2.3 Cast iron with spheroidal graphite, EN-GJS	> 800 N/mm ²	
	K3	K3.1 Cast iron with vermicular graphite, EN-GJV; Malleable cast iron, GJM	< 500 N/mm ²	
		K3.2 Cast iron with vermicular graphite, EN-GJV; Malleable cast iron, GJM	> 500 N/mm ²	
N	N1	N1.1 Aluminium, non-alloyed and alloyed <3% Si		
		N1.2 Aluminium, alloyed <=7% Si		
		N1.3 Aluminium, alloyed > 7-12% Si		
		N1.4 Aluminium, alloyed > 12% Si		
	N2	N2.1 Copper, non-alloyed and low alloyed	< 300 N/mm ²	
		N2.2 Copper, alloyed	> 300 N/mm ²	
		N2.3 Brass, bronze, gun metal	< 1200 N/mm ²	
	N3	N3.1 Graphite		
	N4	N4.1 Plastic, thermoplastic		
		N4.2 Plastic, thermosetting plastic (duroplast)		
		N4.3 Plastic, foam		
	C	C1	C1.1 Plastic matrix, aramid fibre reinforced plastic (AFK)	
C1.2 Plastic matrix (thermosetting), CFRP/GFRP				
C1.3 Plastic matrix (thermoplastic), CFRP/GFRP				
C2		C2.1 Carbon matrix, carbon fibre reinforced (CFC)		
		C3	C3.1 Metal matrix (MMC)	
			C4.1 Sandwich construction, honeycomb core of paper	
			C4.2 Sandwich construction, honeycomb core of aluminium	
C4		C4.3 Sandwich construction, honeycomb core of plastic and fibre composite materials		
		C4.4 Sandwich construction, core of rigid foam		
		C5	C5.1 Stack (hybrid structure) CFRP-aluminium	
C5.2 Stack (hybrid structure) CFRP-titanium/stainless steel				
S	S1	S1.1 Titanium, titanium alloy	< 400 N/mm ²	
		S2.1 Titanium, titanium alloy	< 1200 N/mm ²	
	S2	S2.2 Titanium, titanium alloy	> 1200 N/mm ²	
		S3	S3.1 Nickel, non-alloyed and alloyed	< 900 N/mm ²
	S3.2 Nickel, non-alloyed and alloyed		> 900 N/mm ²	
	S4	S4.1 Heat resistant super alloys, Ni, Co, and Fe based		
	S5	S5.1 Tungsten and molybdenum alloys		
H	H1	H1.1 Hardened steel/cast steel	45-55 HRC	
		H1.2 Hardened steel/cast steel	55-64 HRC	
		H1.3 Hardened steel/cast steel	64-70 HRC	
	H2	H2.3 Wear resistant castings/chilled cast iron, GJN		

	ø < 5 [mm]		ø < 5 - 8 [mm]		ø < 8 - 12 [mm]		ø < 12 - 16 [mm]		ø < 16 - 20 [mm]		ø < 20 - 25 [mm]		ø < 25 - 31 [mm]	
	v _c	f	v _c	f	v _c	f	v _c	f	v _c	f	v _c	f	v _c	f
	60	0,06	60	0,08	60	0,10	60	0,12	60	0,14	60	0,18	60	0,22
	50	0,04	50	0,06	50	0,08	50	0,10	50	0,12	50	0,14	50	0,18
	50	0,04	50	0,06	50	0,08	50	0,10	50	0,12	50	0,14	50	0,18
	40	0,03	40	0,04	40	0,05	40	0,06	40	0,08	40	0,10	40	0,12
	50	0,04	50	0,06	50	0,08	50	0,10	50	0,12	50	0,14	50	0,18
	40	0,03	40	0,04	40	0,05	40	0,06	40	0,08	40	0,10	40	0,12
	30	0,04	30	0,05	30	0,06	30	0,07	30	0,08	30	0,09	30	0,12
	50	0,04	50	0,06	50	0,08	50	0,10	50	0,12	50	0,14	50	0,18
	30	0,04	30	0,05	30	0,06	30	0,07	30	0,08	30	0,09	30	0,12
	30	0,04	30	0,05	30	0,06	30	0,07	30	0,08	30	0,09	30	0,12
	25	0,04	25	0,05	25	0,06	25	0,07	25	0,08	25	0,09	25	0,12
	30	0,04	30	0,05	30	0,06	30	0,07	30	0,08	30	0,09	30	0,12
	25	0,04	25	0,05	25	0,06	25	0,07	25	0,08	25	0,09	25	0,12
	50	0,06	50	0,10	50	0,12	50	0,14	50	0,18	50	0,20	50	0,25
	45	0,06	45	0,10	45	0,12	45	0,14	45	0,18	45	0,20	45	0,25
	45	0,06	45	0,10	45	0,12	45	0,14	45	0,18	45	0,20	45	0,25
	45	0,06	45	0,10	45	0,12	45	0,14	45	0,18	45	0,20	45	0,25
	35	0,06	35	0,10	35	0,12	35	0,14	35	0,18	35	0,20	35	0,25
	35	0,06	35	0,10	35	0,12	35	0,14	35	0,18	35	0,20	35	0,25
	80	0,08	80	0,10	80	0,12	80	0,14	80	0,18	80	0,22	80	0,26
	80	0,08	80	0,10	80	0,12	80	0,14	80	0,18	80	0,22	80	0,26
	60	0,08	60	0,10	60	0,12	60	0,14	60	0,18	60	0,22	60	0,26
	60	0,08	60	0,10	60	0,12	60	0,14	60	0,18	60	0,22	60	0,26
	70	0,10	70	0,12	70	0,14	70	0,18	70	0,20	70	0,24	70	0,30
	70	0,10	70	0,12	70	0,14	70	0,18	70	0,20	70	0,24	70	0,30
	70	0,10	70	0,12	70	0,14	70	0,18	70	0,20	70	0,24	70	0,30
	25	0,06	25	0,10	25	0,12	25	0,14	25	0,18	25	0,20	25	0,25
	70	0,10	70	0,12	70	0,14	70	0,18	70	0,20	70	0,24	70	0,30
	70	0,10	70	0,12	70	0,14	70	0,18	70	0,20	70	0,24	70	0,30
	70	0,10	70	0,12	70	0,14	70	0,18	70	0,20	70	0,24	70	0,30
	25	0,06	25	0,10	25	0,12	25	0,14	25	0,18	25	0,20	25	0,25
	25	0,06	25	0,10	25	0,12	25	0,14	25	0,18	25	0,20	25	0,25
	25	0,06	25	0,10	25	0,12	25	0,14	25	0,18	25	0,20	25	0,25
	25	0,06	25	0,10	25	0,12	25	0,14	25	0,18	25	0,20	25	0,25
	25	0,06	25	0,10	25	0,12	25	0,14	25	0,18	25	0,20	25	0,25
	25	0,06	25	0,10	25	0,12	25	0,14	25	0,18	25	0,20	25	0,25
	25	0,06	25	0,10	25	0,12	25	0,14	25	0,18	25	0,20	25	0,25
	25	0,06	25	0,10	25	0,12	25	0,14	25	0,18	25	0,20	25	0,25
	25	0,06	25	0,10	25	0,12	25	0,14	25	0,18	25	0,20	25	0,25
	25	0,06	25	0,10	25	0,12	25	0,14	25	0,18	25	0,20	25	0,25
	15	0,05	15	0,06	15	0,07	15	0,08	15	0,09	15	0,10	15	0,12
	15	0,05	15	0,06	15	0,07	15	0,08	15	0,09	15	0,10	15	0,12
	15	0,05	15	0,06	15	0,07	15	0,08	15	0,09	15	0,10	15	0,12
	15	0,05	15	0,06	15	0,07	15	0,08	15	0,09	15	0,10	15	0,12
	15	0,05	15	0,06	15	0,07	15	0,08	15	0,09	15	0,10	15	0,12
	15	0,05	15	0,06	15	0,07	15	0,08	15	0,09	15	0,10	15	0,12
	12	0,04	12	0,05	12	0,06	12	0,08	12	0,08	12	0,10		
	8	0,04	8	0,05	8	0,06	8	0,08	8	0,08	8	0,10		
	12	0,04	12	0,05	12	0,06	12	0,08	12	0,08	12	0,10		

Parameters:

The recommended parameters are reference values.
 These can be adapted depending on the application environment (machine, fixture).

Cutting data for countersinks, 90°

Cutting material: solid carbide, uncoated

Feed f [mm/rev], cutting speed vc [m/min]

ZG*		Material	Strength/Hardness [N/mm ²] [HRC]
P	P1	P1.1 Structural, free-cutting, case hardened and heat-treated steel, non-alloyed	< 700 N/mm ²
		P1.2 Structural, free-cutting, case hardened and heat-treated steel, non-alloyed	< 1200 N/mm ²
	P2	P2.1 Nitratated, case hardened and heat-treated steel, alloyed	< 900 N/mm ²
		P2.2 Nitratated, case hardened and heat-treated steel, alloyed	< 1400 N/mm ²
	P3	P3.1 Tool, roller bearing, spring and high speed steel	< 900 N/mm ²
		P3.2 Tool, roller bearing, spring and high speed steel	< 1500 N/mm ²
P4	P4.1 Stainless steel, ferritic and martensitic		
P5	P5.1 Cast steel		
P6	P6.1 Stainless cast steel, ferritic and martensitic		
M	M1	M1.1 Stainless steel, austenitic	< 700 N/mm ²
		M1.2 Stainless steel, ferritic/austenitic (Duplex)	< 1000 N/mm ²
	M2	M2.1 Stainless cast steel, austenitic	< 700 N/mm ²
		M2.2 Stainless cast steel, ferritic/austenitic (Duplex)	< 1000 N/mm ²
K	K1	K1.1 Cast iron with lamellar graphite (grey cast iron), EN-GJL	< 300 N/mm ²
		K2.1 Cast iron with spheroidal graphite, EN-GJS	< 500 N/mm ²
	K2	K2.2 Cast iron with spheroidal graphite, EN-GJS	500-800 N/mm ²
		K2.3 Cast iron with spheroidal graphite, EN-GJS	> 800 N/mm ²
	K3	K3.1 Cast iron with vermicular graphite, EN-GJV; Malleable cast iron, GJM	< 500 N/mm ²
		K3.2 Cast iron with vermicular graphite, EN-GJV; Malleable cast iron, GJM	> 500 N/mm ²
N	N1	N1.1 Aluminium, non-alloyed and alloyed <3% Si	
		N1.2 Aluminium, alloyed <=7% Si	
		N1.3 Aluminium, alloyed > 7-12% Si	
		N1.4 Aluminium, alloyed > 12% Si	
	N2	N2.1 Copper, non-alloyed and low alloyed	< 300 N/mm ²
		N2.2 Copper, alloyed	> 300 N/mm ²
		N2.3 Brass, bronze, gun metal	< 1200 N/mm ²
	N3	N3.1 Graphite	
		N4.1 Plastic, thermoplastic	
		N4.2 Plastic, thermosetting plastic (duroplast)	
N4.3 Plastic, foam			
S	S1	S1.1 Titanium, titanium alloy	< 400 N/mm ²
		S2.1 Titanium, titanium alloy	< 1200 N/mm ²
	S2	S2.2 Titanium, titanium alloy	> 1200 N/mm ²
		S3.1 Nickel, non-alloyed and alloyed	< 900 N/mm ²
	S3	S3.2 Nickel, non-alloyed and alloyed	> 900 N/mm ²
		S4.1 Heat resistant super alloys, Ni, Co, and Fe based	
S5	S5.1 Tungsten and molybdenum alloys		
H	H1	H1.1 Hardened steel/cast steel	45-55 HRC
		H1.2 Hardened steel/cast steel	55-64 HRC
		H1.3 Hardened steel/cast steel	64-70 HRC
	H2	N2.3 Wear resistant castings/chilled cast iron, GJN	

	ø > 5 - 8 [mm]		ø > 8 - 12,4 [mm]		ø > 12,4 - 16,5 [mm]		ø > 16,5 - 20,5 [mm]		ø > 20,5 - 25 [mm]		ø > 25 - 31 [mm]	
	v _c	f	v _c	f	v _c	f	v _c	f	v _c	f	v _c	f
	40	0,08	40	0,10	40	0,12	40	0,14	40	0,18	40	0,22
	18	0,04	18	0,05	18	0,06	18	0,08	18	0,10	18	0,12
	30	0,06	30	0,08	30	0,10	30	0,12	30	0,14	30	0,18
	18	0,04	18	0,05	18	0,06	18	0,08	18	0,10	18	0,12
	30	0,06	30	0,08	30	0,10	30	0,12	30	0,14	30	0,18
	18	0,04	18	0,05	18	0,06	18	0,08	18	0,10	18	0,12
	16	0,05	16	0,06	16	0,07	16	0,08	16	0,09	16	0,12
	30	0,06	30	0,08	30	0,10	30	0,12	30	0,14	30	0,18
	16	0,05	16	0,06	16	0,07	16	0,08	16	0,10	16	0,12
	16	0,05	16	0,06	16	0,07	16	0,08	16	0,09	16	0,12
	16	0,05	16	0,06	16	0,07	16	0,08	16	0,09	16	0,12
	16	0,05	16	0,06	16	0,07	16	0,08	16	0,09	16	0,12
	16	0,05	16	0,06	16	0,07	16	0,08	16	0,09	16	0,12
	25	0,10	25	0,12	25	0,14	25	0,18	25	0,20	25	0,25
	25	0,10	25	0,12	25	0,14	25	0,18	25	0,20	25	0,25
	18	0,10	18	0,12	18	0,14	18	0,18	18	0,20	18	0,25
	18	0,10	18	0,12	18	0,14	18	0,18	18	0,20	18	0,25
	25	0,10	25	0,12	25	0,14	25	0,18	25	0,20	25	0,25
	18	0,10	18	0,12	18	0,14	18	0,18	18	0,20	18	0,25
	60	0,10	60	0,12	60	0,14	60	0,18	60	0,22	60	0,26
	60	0,10	60	0,12	60	0,14	60	0,18	60	0,22	60	0,26
	45	0,10	45	0,12	45	0,14	45	0,18	45	0,22	45	0,26
	45	0,10	45	0,12	45	0,14	45	0,18	45	0,22	45	0,26
	50	0,12	50	0,14	50	0,18	50	0,20	50	0,20	50	0,30
	50	0,12	50	0,14	50	0,18	50	0,20	50	0,20	50	0,30
	50	0,12	50	0,14	50	0,18	50	0,20	50	0,20	50	0,30
	50	0,12	50	0,14	50	0,18	50	0,20	50	0,20	50	0,30
	50	0,12	50	0,14	50	0,18	50	0,20	50	0,20	50	0,30
	50	0,12	50	0,14	50	0,18	50	0,20	50	0,20	50	0,30
	12	0,04	12	0,05	12	0,06	12	0,07	12	0,08	12	0,10
	12	0,04	12	0,05	12	0,06	12	0,07	12	0,08	12	0,10
	12	0,04	12	0,05	12	0,06	12	0,07	12	0,08	12	0,10
	12	0,04	12	0,05	12	0,06	12	0,07	12	0,08	12	0,10
	12	0,04	12	0,05	12	0,06	12	0,07	12	0,08	12	0,10
	12	0,04	12	0,05	12	0,06	12	0,07	12	0,08	12	0,10
	12	0,04	12	0,05	12	0,06	12	0,07	12	0,08	12	0,10
	8	0,05	8	0,06	8	0,08	8	0,08	8	0,10	8	0,12
	---	---	---	---	---	---	---	---	---	---	---	---
	---	---	---	---	---	---	---	---	---	---	---	---
	---	---	---	---	---	---	---	---	---	---	---	---

Parameters:

The recommended parameters are reference values.
 These can be adapted depending on the application environment (machine, fixture).

Cutting data for countersinks, 90° und 60°

Cutting material: HSS, coated und uncoated

Feed f [mm/rev], cutting speed vc [m/min]

ZG*		Material	Strength/Hardness [N/mm ²] [HRC]
P	P1	P1.1 Structural, free-cutting, case hardened and heat-treated steel, non-alloyed	< 700 N/mm ²
		P1.2 Structural, free-cutting, case hardened and heat-treated steel, non-alloyed	< 1200 N/mm ²
	P2	P2.1 Nitratet, case hardened and heat-treated steel, alloyed	< 900 N/mm ²
		P2.2 Nitratet, case hardened and heat-treated steel, alloyed	< 1400 N/mm ²
	P3	P3.1 Tool, roller bearing, spring and high speed steel	< 900 N/mm ²
		P3.2 Tool, roller bearing, spring and high speed steel	< 1500 N/mm ²
	P4	P4.1 Stainless steel, ferritic and martensitic	
	P5	P5.1 Cast steel	
	P6	P6.1 Stainless cast steel, ferritic and martensitic	
	M	M1	M1.1 Stainless steel, austenitic
M1.2 Stainless steel, ferritic/austenitic (Duplex)			< 1000 N/mm ²
M2		M2.1 Stainless cast steel, austenitic	< 700 N/mm ²
M3		M3.1 Stainless cast steel, ferritic/austenitic (Duplex)	< 1000 N/mm ²
K	K1	K1.1 Cast iron with lamellar graphite (grey cast iron), EN-GJL	< 300 N/mm ²
		K2.1 Cast iron with spheroidal graphite, EN-GJS	< 500 N/mm ²
	K2	K2.2 Cast iron with spheroidal graphite, EN-GJS	500-800 N/mm ²
		K2.3 Cast iron with spheroidal graphite, EN-GJS	> 800 N/mm ²
	K3	K3.1 Cast iron with vermicular graphite, EN-GJV; Malleable cast iron, GJM	< 500 N/mm ²
		K3.2 Cast iron with vermicular graphite, EN-GJV; Malleable cast iron, GJM	> 500 N/mm ²
N	N1	N1.1 Aluminium, non-alloyed and alloyed <3% Si	
		N1.2 Aluminium, alloyed <=7% Si	
		N1.3 Aluminium, alloyed > 7-12% Si	
		N1.4 Aluminium, alloyed > 12% Si	
	N2	N2.1 Copper, non-alloyed and low alloyed	< 300 N/mm ²
		N2.2 Copper, alloyed	> 300 N/mm ²
		N2.3 Brass, bronze, gun metal	< 1200 N/mm ²
	N3	N3.1 Graphite	
	N4	N4.1 Plastic, thermoplastic	
		N4.2 Plastic, thermosetting plastic (duroplast)	
N4.3 Plastic, foam			
S	S1	S1.1 Titanium, titanium alloy	< 400 N/mm ²
		S2.1 Titanium, titanium alloy	< 1200 N/mm ²
	S2	S2.2 Titanium, titanium alloy	> 1200 N/mm ²
		S3.1 Nickel, non-alloyed and alloyed	< 900 N/mm ²
	S3	S3.2 Nickel, non-alloyed and alloyed	> 900 N/mm ²
		S4	S4.1 Heat resistant super alloys, Ni, Co, and Fe based
S5	S5.1 Tungsten and molybdenum alloys		
H	H1	H1.1 Hardened steel/cast steel	45-55 HRC
		H1.2 Hardened steel/cast steel	55-64 HRC
		H1.3 Hardened steel/cast steel	64-70 HRC
	H2	H2.3 Wear resistant castings/chilled cast iron, GJN	

	ø > 5 [mm]		ø > 5 - 8 [mm]		ø > 8 - 12,4 [mm]		ø > 12,4 - 16,5 [mm]		ø > 16,5 - 20,5 [mm]		ø > 20,5 - 25 [mm]		ø > 25 - 40 [mm]		ø > 40 - 63 [mm]		ø > 63 - 100 [mm]	
	v _c	f	v _c	f	v _c	f	v _c	f	v _c	f	v _c	f	v _c	f	v _c	f	v _c	f
	30	0,06	30	0,08	30	0,10	30	0,12	30	0,14	30	0,18	30	0,22	30	0,30	30	0,35
	10	0,03	10	0,04	10	0,05	10	0,06	10	0,08	10	0,10	10	0,12	10	0,16	10	0,20
	25	0,04	25	0,06	25	0,08	25	0,10	25	0,12	25	0,14	25	0,18	25	0,25	25	0,30
	10	0,03	10	0,04	10	0,05	10	0,06	10	0,08	10	0,10	10	0,12	10	0,16	10	0,20
	10	0,03	10	0,04	10	0,05	10	0,06	10	0,08	10	0,10	10	0,12	10	0,16	10	0,20
	10	0,03	10	0,04	10	0,05	10	0,06	10	0,08	10	0,10	10	0,12	10	0,16	10	0,20
	25	0,04	25	0,06	25	0,08	25	0,10	25	0,12	25	0,14	25	0,18	25	0,25	25	0,30
	8	0,04	8	0,05	8	0,06	8	0,07	8	0,08	8	0,09	8	0,12	8	0,14	8	0,20
	8	0,04	8	0,05	8	0,06	8	0,07	8	0,08	8	0,09	8	0,12	8	0,14	8	0,20
	8	0,04	8	0,05	8	0,06	8	0,07	8	0,08	8	0,09	8	0,12	8	0,14	8	0,20
	8	0,04	8	0,05	8	0,06	8	0,07	8	0,08	8	0,09	8	0,12	8	0,14	8	0,20
	12	0,06	12	0,10	12	0,12	12	0,14	12	0,18	12	0,20	12	0,25	12	0,28	12	0,33
	12	0,06	12	0,10	12	0,12	12	0,14	12	0,18	12	0,20	12	0,25	12	0,28	12	0,33
	10	0,06	10	0,10	10	0,12	10	0,14	10	0,18	10	0,20	10	0,25	10	0,28	10	0,33
	10	0,06	10	0,10	10	0,12	10	0,14	10	0,18	10	0,20	10	0,25	10	0,28	10	0,33
	12	0,06	12	0,10	12	0,12	12	0,14	12	0,18	12	0,20	12	0,25	12	0,28	12	0,33
	10	0,06	10	0,10	10	0,12	10	0,14	10	0,18	10	0,20	10	0,25	10	0,28	10	0,33
	35	0,08	35	0,10	35	0,12	35	0,14	35	0,18	35	0,22	35	0,26	35	0,30	35	0,35
	35	0,08	35	0,10	35	0,12	35	0,14	35	0,18	35	0,22	35	0,26	35	0,30	35	0,35
	25	0,08	25	0,10	25	0,12	25	0,14	25	0,18	25	0,22	25	0,26	25	0,30	25	0,35
	25	0,08	25	0,10	25	0,12	25	0,14	25	0,18	25	0,22	25	0,26	25	0,30	25	0,35
	35	0,10	35	0,12	35	0,14	35	0,18	35	0,20	35	0,24	35	0,30	35	0,40	35	0,45
	35	0,10	35	0,12	35	0,14	35	0,18	35	0,20	35	0,24	35	0,30	35	0,40	35	0,45
	35	0,10	35	0,12	35	0,14	35	0,18	35	0,20	35	0,24	35	0,30	35	0,40	35	0,45
	35	0,10	35	0,12	35	0,14	35	0,18	35	0,20	35	0,24	35	0,30	35	0,40	35	0,45
	35	0,10	35	0,12	35	0,14	35	0,18	35	0,20	35	0,24	35	0,30	35	0,40	35	0,45
	8	0,04	8	0,05	8	0,06	8	0,07	8	0,08	8	0,09	8	0,12	8	0,14	8	0,18
	8	0,04	8	0,05	8	0,06	8	0,07	8	0,08	8	0,09	8	0,12	8	0,14	8	0,18
	8	0,04	8	0,05	8	0,06	8	0,07	8	0,08	8	0,09	8	0,12	8	0,14	8	0,18
	8	0,04	8	0,05	8	0,06	8	0,07	8	0,08	8	0,09	8	0,12	8	0,14	8	0,18
	8	0,04	8	0,05	8	0,06	8	0,07	8	0,08	8	0,09	8	0,12	8	0,14	8	0,18
	8	0,04	8	0,05	8	0,06	8	0,07	8	0,08	8	0,09	8	0,12	8	0,14	8	0,18
	8	0,04	8	0,05	8	0,06	8	0,07	8	0,08	8	0,09	8	0,12	8	0,14	8	0,18
	4	0,04	4	0,05	4	0,06	4	0,08	4	0,10								

Parameters:

The recommended parameters are reference values.
 These can be adapted depending on the application environment (machine, fixture).

Handling notes for replaceable heads XR 01, XR 06

The universal replaceable heads in the XR series feature a complete and particularly user-friendly programme. The XS connection ensures the straightforward, fast changing of the replaceable heads with high accuracy of repetition. At the same time perfect retention with maximum stability and rigidity is achieved.

The replaceable head is tightened to the stipulated tightening torque and produces a joint with force and form fit. The key features of this system are high radial run-out accuracy in conjunction with very good rigidity.

Assembly of the replaceable heads XR

Note:

To minimise the risk of injuries, it is recommended to wear gloves for the following actions.

Note:

Only for trained personnel.



1. Clean the taper, thread and face surface on the replaceable head using compressed air and a cloth.



2. Clean the taper, thread and face surface on the replaceable head holder using compressed air and a cloth.

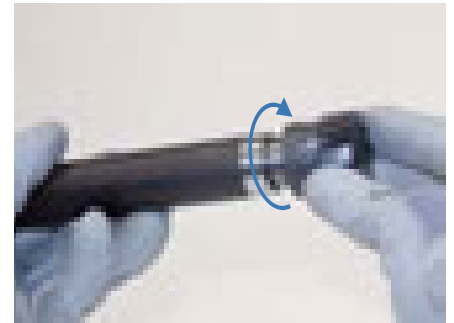

3. Screw the replaceable head clockwise into the replaceable head holder so it is hand-tight. Then clamp the replaceable head holder with the tool in the machine holder.

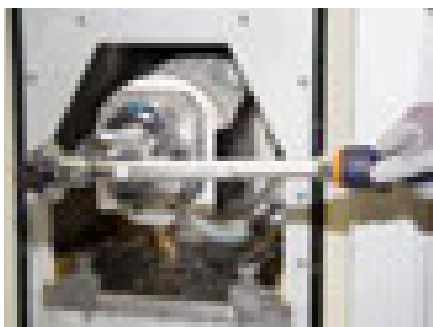

4. Place the torque wrench on the replaceable head so it is as horizontal as possible; do not tilt the faces on the spanner.

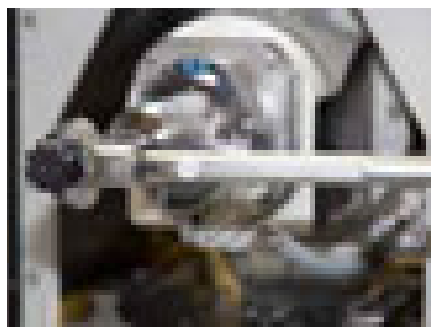

5. Tighten the replaceable head to the stated tightening torque with the aid of the torque wrench and the appropriate open-ended spanner attachment (see table "Tightening torques for the replaceable heads").



Result:

The gap between the replaceable head and replaceable head holder is closed and a joint with a force and form fit is formed. The replaceable head XR is now ready to use.

Tightening torques for replaceable heads

Connection size XS	Tightening torque [Nm]
6	5
8	12,5
10	15
12	20
16	25
20	30

Handling notes for cutting rings MultiCut

Adjustable cutting rings with conical sleeve

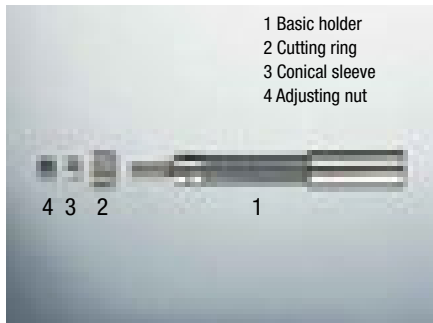

Thoroughly clean all individual parts, then lightly grease the thread on the basic holder (copper grease recommended).



Push cutting ring onto the basic holder (pay attention to direction of cutting ring).

Caution: With internal coolant supply, centre punch marks on the cutting ring and the basic holder must be aligned.



Push conical sleeve onto the basic holder.



Tighten adjusting nut hand-tight in the direction of the arrow (pay attention to symbols on the adjusting nut).

Caution: The recess on the cutting ring must lie in the direction of rotation of the tool against the driving element pin.



Adjust cutting ring by tightening the adjusting nut to the nominal size. Measuring blades are marked with a centre punch, a number or a rib behind the cutting edge.

General figures for tightening torque "adjustable cutting rings"

∅ range	Nm	ft/lbs
18 – 25	18 – 22	13 – 16
26 – 32	28 – 33	21 – 24
33 – 40	48 – 55	35 – 41
41 – 45	65 – 75	48 – 55
46 – 60	90 – 110	66 – 81
61 – 79	120 – 140	88 – 103
80 – 100	180 – 220	133 – 162

Handling notes for cutting rings MultiCut

Adjustable cutting rings with conical screw

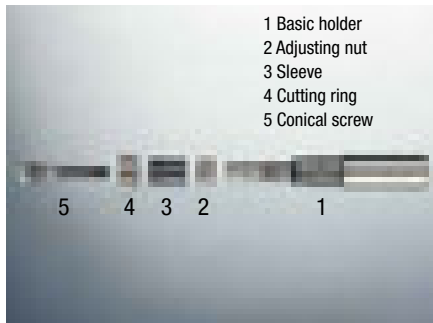

Thoroughly clean all individual parts, then lightly grease the thread on the holder and conical screw (copper grease recommended).



Screw adjusting nut all the way onto the thread.

Caution: Against the direction of the arrow to the adjusting nut.
(Pay attention to symbol on the adjusting nut).



Push sleeve on the basic holder (pay attention to coolant outlet bore).



Tighten the adjusting nut hand-tight in the direction of the arrow.

Caution: The recess on the cutting ring must lie in the direction of rotation of the tool against the driving element pin. On tools with internal cooling lubricant supply, the coolant bores (in the sleeve) must be aligned on the cutting edges.



Adjust cutting ring by tightening the adjusting nut to the nominal size. Measuring blades are marked with a centre punch, a number or a rib behind the cutting edge.



Push cutting ring onto the conical screw (cutting edges first).

Important: The shoulder on the conical screw as well as the face on the holder must be free of grease.



Screw conical screw with cutting ring into the basic holder to the stop.

Caution: With internal coolant supply, centre punch marks on the cutting ring and the sleeve must be aligned.



Tighten conical screw as per table of general figures using torque wrench.

General figures for tightening torque "adjustable cutting rings"

ø range	Nm	ft/lbs
18 – 25	18 – 22	13 – 16
26 – 32	28 – 33	21 – 24
33 – 40	48 – 55	35 – 41
41 – 45	65 – 75	48 – 55
46 – 60	90 – 110	66 – 81
61 – 79	120 – 140	88 – 103
80 – 100	180 – 220	133 – 162

Innovation, precision, variety! Three specialists deliver the perfect tools for success in your retail business.

BECK
MAPAL GROUP

Best in reaming and countersinking

The competence and experience from more than 100 years make BECK a dependable partner in demand for bore machining. The comprehensive standard programme includes reaming and countersinking tools and covers the complete cutting material spectrum from HSS to PCD and PcBN. This programme is supplemented by high performance reamers and custom tools that offer users that crucial performance plus.

MILLER
MAPAL GROUP

Innovative drilling and milling

One of the largest and most modern factories for solid carbide tools in Europe produces drills and milling cutters that have yet to find their equal. Because when it comes to high-precision standard solutions for drilling and milling, MILLER is the acknowledged specialist. The diverse program line consists of solid carbide tools for almost any application. Know-how, quality and focus on retail business are the features that best describe our company and our products.

WTE
MAPAL GROUP

Reliable clamping technology

WTE is the specialist in innovative tool adapters. The extensive product line of Precision Drill Chucks, Hydraulic Chucks, Shrink Chucks, HPH Universal Chucks and MICRO Chucks fills every need for modern high-precision machining. WTE stands for precision and quality combined with high competence as a reliable clamping systems partner for your retail business.

tool-traders-partner.com

Three good reasons for more success



„Made in Germany“ Top Services and Top Products

We are convinced that the high demands of precision-dependent industries are met only by products developed and manufactured in Germany. The most modern manufacturing processes, production systems and infrastructure as well as qualified and dedicated employees make it possible to achieve very high performance standards. That means the highest quality features in the micron range for our products, combined with an attractive price-to-performance ratio. All companies in „tool-traders-partner“ have active quality management systems and are certified in accordance with ISO 9001:2008



Technical Competence – Available Worldwide

All the companies in „tool-traders-partner“ are technology leaders and their brands enjoy a high level of familiarity internationally and an excellent image. With our practically oriented tool specialists, we have access to a pool of information from decades of experience and collective specialist knowledge. We stand for continuity, technological competence and innovative strength. For retail business this means: Always being in touch with the latest in tool technology and know-how.



Optimum Customer Service

Our extensive range of products available from stock, efficient logistics and high flexibility guarantee very high availability of products for retail. As part of our strategic alignment with retail business, we offer a whole package of services such as sales consulting, support from application specialists, training courses and marketing support. This makes it possible for you to continuously expand your competence while ensuring unparalleled service for you and your customers

Symbols

Features		Works standard	DIN standard	Similar DIN standard																																																																																																									
		Internal coolant supply	Cylindrical shank as per DIN 6535	Morse taper shank (MK)																																																																																																									
Design		Monolithic	Modular system XS	Cutting ring system																																																																																																									
Bore		Through bore	Blind bore	Interrupted cut																																																																																																									
Product line		Basic Line: Universal tools, broad application area, low procurement costs	Performance Line: High-performance tools, broad application area, high productivity in series production																																																																																																										
		Expert Line: Specialist tools for selected applications, maximum precision and productivity																																																																																																											
Suitability		Highly suitable	Limited suitability	Suitable only with special geometry or special coating																																																																																																									
		<p>Example standard suitability overview</p> <table border="1"> <tr> <td>P</td><td>1</td><td>2</td><td>3</td><td>4</td><td>5</td><td>6</td><td>M</td><td>1</td><td>2</td><td>3</td><td>K</td><td>1</td><td>2</td><td>3</td><td>N</td><td>1</td><td>2</td><td>3</td><td>4</td><td>S</td><td>1</td><td>2</td><td>3</td><td>4</td><td>5</td><td>H</td><td>1</td><td>2</td> </tr> <tr> <td>■</td><td>■</td><td>■</td><td>■</td><td>■</td><td>■</td><td>■</td><td>■</td><td>■</td><td>■</td><td>■</td><td>■</td><td>■</td><td>■</td><td>■</td><td>■</td><td>■</td><td>■</td><td>■</td><td>■</td><td>■</td><td>■</td><td>■</td><td>■</td><td>■</td><td>■</td><td>■</td><td>■</td><td>■</td> </tr> </table> <p>Example suitability overview for non-ferrous materials and composites</p> <table border="1"> <tr> <td>N</td><td>1.1</td><td>1.2</td><td>1.3</td><td>1.4</td><td>2.1</td><td>2.2</td><td>2.3</td><td>3.1</td><td>4.1</td><td>4.2</td><td>4.3</td><td>C</td><td>1.1</td><td>1.2</td><td>1.3</td><td>2.1</td><td>3.1</td><td>4.1</td><td>4.2</td><td>4.3</td><td>4.4</td><td>5.1</td><td>5.2</td> </tr> <tr> <td>■</td><td>■</td><td>■</td><td>■</td><td>■</td><td>■</td><td>■</td><td>■</td><td>■</td><td>■</td><td>■</td><td>■</td><td>■</td><td>■</td><td>■</td><td>■</td><td>■</td><td>■</td><td>■</td><td>■</td><td>■</td><td>■</td><td>■</td><td>■</td> </tr> </table>				P	1	2	3	4	5	6	M	1	2	3	K	1	2	3	N	1	2	3	4	S	1	2	3	4	5	H	1	2	■	■	■	■	■	■	■	■	■	■	■	■	■	■	■	■	■	■	■	■	■	■	■	■	■	■	■	■	■	N	1.1	1.2	1.3	1.4	2.1	2.2	2.3	3.1	4.1	4.2	4.3	C	1.1	1.2	1.3	2.1	3.1	4.1	4.2	4.3	4.4	5.1	5.2	■	■	■	■	■	■	■	■	■	■	■	■	■	■	■	■	■	■	■	■	■	■
P	1	2	3	4	5	6	M	1	2	3	K	1	2	3	N	1	2	3	4	S	1	2	3	4	5	H	1	2																																																																																	
■	■	■	■	■	■	■	■	■	■	■	■	■	■	■	■	■	■	■	■	■	■	■	■	■	■	■	■	■																																																																																	
N	1.1	1.2	1.3	1.4	2.1	2.2	2.3	3.1	4.1	4.2	4.3	C	1.1	1.2	1.3	2.1	3.1	4.1	4.2	4.3	4.4	5.1	5.2																																																																																						
■	■	■	■	■	■	■	■	■	■	■	■	■	■	■	■	■	■	■	■	■	■	■	■																																																																																						

General information on the catalogue:

We supply exclusively on the basis of our terms of delivery and payment (see www.beck-tools.de). With the release of this catalogue, the corresponding previous catalogue versions are superseded. Changes and deviations from standards reserved. No claims shall be derived from printing errors in technical data. Reprinting, in whole or in part, is not permitted without our express approval.

Further information about prices and availabilities of all products shown in this catalogue see in our current price list.

Explanation of the dimensions:

d_1 = Tool diameter

d_2 = Shank diameter

d_3 = Smallest tool diameter

l_1 = Total length of the tool

l_2 = Cutting length

l_3 = Length of the tool shank

l_4 = Projection length

l_5 = Usable working depth

xs = Connection size

sw = Wrench size

z = Number of cutting edges

MK = Morse taper size

August Beck GmbH & Co. KG

Ebinger Straße 115, 72474 Winterlingen, Germany

Phone +49 74 34 270 0

E-mail: info@beck-tools.de

BECK machining groups

BECK machining groups provide precise information about the suitability of our tools on specific materials. Key fact to be classified into groups is the cutting property due to the materials cutting data (cutting speed and feed). Within specific machining groups it is necessary to subdivide them due to their tensile strength and their hardness.

Machining group		Material	Strength - Hardness [N/mm ² - HRC]	Material examples
P	P1	P1.1 Structural, free-cutting, case hardened and heat-treated steel, non-alloyed	< 700 N/mm ²	S235JR+AR (St37-2), S355J2+N (St52-3), C15, C45, Cf53
		P1.2 Structural, free-cutting, case hardened and heat-treated steel, non-alloyed	< 1200 N/mm ²	Cf70
	P2	P2.1 Nitratred, case hardened and heat-treated steel, alloyed	< 900 N/mm ²	16MnCr5
		P2.2 Nitratred, case hardened and heat-treated steel, alloyed	< 1400 N/mm ²	42CrMoS4
	P3	P3.1 Tool, roller bearing, spring and high speed steel	< 900 N/mm ²	X38CrMoV5-1
		P3.2 Tool, roller bearing, spring and high speed steel	< 1500 N/mm ²	100Cr6
P4	P4.1 Stainless steel, ferritic and martensitic		X3CrTi17, X5CrNiMoTi15-2	
P5	P5.1 Cast steel		G42CrMo4	
P6	P6.1 Stainless cast steel, ferritic and martensitic			
M	M1	M1.1 Stainless steel, austenitic	< 700 N/mm ²	X5CrNi18-10 (V2A), X6CrNiMoTi17-12-2 (V4A)
		M1.2 Stainless steel, ferritic/austenitic (Duplex)	< 1000 N/mm ²	X2CrNiN23-4 (Alloy 2304), X2CrNiMoCuWN25-7-4, X2CrNiMoN22-5-3 (LDX 2404)
	M2	M2.1 Stainless cast steel, austenitic	< 700 N/mm ²	
M3	M3.1 Stainless cast steel, ferritic/austenitic (Duplex)	< 1000 N/mm ²		
K	K1	K1.1 Cast iron with lamellar graphite (grey cast iron), EN-GJL	< 300 N/mm ²	GG-25, GG-26 Cr
		K2.1 Cast iron with spheroidal graphite, EN-GJS	< 500 N/mm ²	GGG-40, GGG-45
	K2	K2.2 Cast iron with spheroidal graphite, EN-GJS	500-800 N/mm ²	GGG-60, GGG-80, ADI 800
		K2.3 Cast iron with spheroidal graphite, EN-GJS	> 800 N/mm ²	GGG-90, ADI 1000, ADI 1200, ADI 1400
	K3	K3.1 Cast iron with vermicular graphite, EN-GJV; Malleable cast iron, GJM	< 500 N/mm ²	GJV-300, GJV-400, GTW-40
K3.2 Cast iron with vermicular graphite, EN-GJV; Malleable cast iron, GJM		> 500 N/mm ²	GJV-500	
N	N1	N1.1 Aluminium, non-alloyed and alloyed <3% Si		Alloy 2024, Alloy 7075, Al99
		N1.2 Aluminium, alloyed <=7% Si		AlSi7
		N1.3 Aluminium, alloyed > 7-12% Si		AlSi9, AlSi9Cu
		N1.4 Aluminium, alloyed > 12% Si		AlSi12, AlSi17
	N2	N2.1 Copper, non-alloyed and low alloyed	< 300 N/mm ²	SE-Cu
		N2.2 Copper, alloyed	> 300 N/mm ²	CuSn6
		N2.3 Brass, bronze, gun metal	< 1200 N/mm ²	CuZn33, CuAl9Mn3
	N3	N3.1 Graphite		
	N4	N4.1 Plastic, thermoplastic		PA, PE, PC, PS, PVC, PP, PTFE, POM, PMMA
		N4.2 Plastic, thermosetting plastic (duroplast)		PU, PF, EP, UP, VE, CR
N4.3 Plastic, foam			EPS, PUR, PVC-E, PS-E, PP-E	
C	C1	C1.1 Plastic matrix, aramid fibre reinforced plastic (AFK)		Nomex, Kevlar, Twaron, KOREX
		C1.2 Plastic matrix (thermosetting), CFRP/GFRP		IMS, HTA
		C1.3 Plastic matrix (thermoplastic), CFRP/GFRP		GMT-PP, PEEK
	C2	C2.1 Carbon matrix, carbon fibre reinforced (CFC)		CF222, CF225, CF226, CF227, CF260
	C3	C3.1 Metal matrix (MMC)		CeramTec AO-403 (AlSi9MgMn-Al2O3), Al/Cu/Mg-SiO2/Al2O3/AlN/TiC/SiC/BN/TiB2
C4	C4.1 Sandwich construction, honeycomb core of paper			
	C4.2 Sandwich construction, honeycomb core of aluminium		PLASCORE PAMG-XR1 5052, PCGA-XR1 3003, PAMG-XR1 5056, Micro-Cell (Kern aus Alloy 5052/5056)	
	C4.3 Sandwich construction, honeycomb core of plastic and fibre composite materials		CORMASTER, TUBUS, KOREX, HFT-G, TPU, HFT, HRH (HRH-10, HRH-310, HRH-78, HRH-49, HRH-327), HDC-F	
	C4.4 Sandwich construction, core of rigid foam		AIREX R63, AIREX C70, ROHACELL IG-F	
C5	C5.1 Stack (hybrid structure) CFRP-aluminium		IMS/HTA + Alloy 2024/6061/7075	
	C5.2 Stack (hybrid structure) CFRP-titanium/stainless steel		IMS/HTA + TiAl6V4/AMS4905	
S	S1	S1.1 Titanium, titanium alloy	< 400 N/mm ²	
		S2.1 Titanium, titanium alloy	< 1200 N/mm ²	TiAl6V4
	S2	S2.2 Titanium, titanium alloy	> 1200 N/mm ²	
		S3.1 Nickel, non-alloyed and alloyed	< 900 N/mm ²	Ni36 (Invar)
	S3	S3.2 Nickel, non-alloyed and alloyed	> 900 N/mm ²	
S4	S4.1 Heat resistant super alloys, Ni, Co, and Fe based		Hardox, Hastelloy, Incoloy, Inconel, NIMONIC, Stellite, Waspaloy	
S5	S5.1 Tungsten and molybdenum alloys			
H	H1	H1.1 Hardened steel/cast steel	45-55 HRC	
		H1.2 Hardened steel/cast steel	55-64 HRC	
	H1.3 Hardened steel/cast steel	64-70 HRC		
H2	H2.1 Wear resistant castings/chilled cast iron, GJN			



BECK
MAPAL GROUP

Your Specialist for
Multi-bladed Reamers and Counterboring Tools

High Performance Reamers
with internal coolant supply in a monobloc design
and modular system

Machine Reamers without internal coolant supply
in accordance with DIN or similar to DIN

Hand Reamers and Taper Reamers

Core Drills

Countersinks / Counterbores / Deburring Tools

www.beck-tools.de