

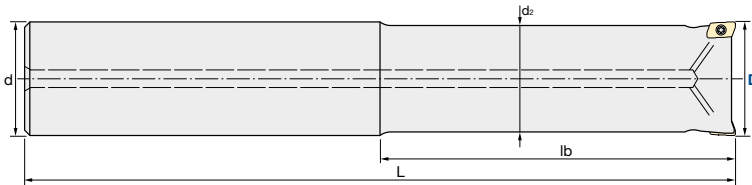
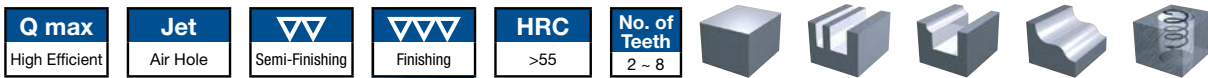
ASPV | Super Polish Mill-Mini | Shank Type


Fig. 1: Steel Shank

Diameter Holder only [mm]	Fastening Torque [Nm]
-0.046 / -0.096 mm	0.5 Nm

Shank Type		Flutes	D	L	lb	d	d ₂	Shank	Coolant hole	a _p max
FH227	ASPV-1010R-2	2	10	100	30	10	9.4	Steel (Fig. 1)	With coolant hole	2
FH228	ASPV-1012R-3	3	12		40	12	11.2			
FH229	ASPV-1016R-4	4	16	130	50	16	14.5			
FH230	ASPV-1020R-5	5	20	160	60	20	18			
FH231	ASPV-1025R-6	6	25	180	75	25	23			
FH232	ASPV-1032R-8	8	32	200	100	32	30			

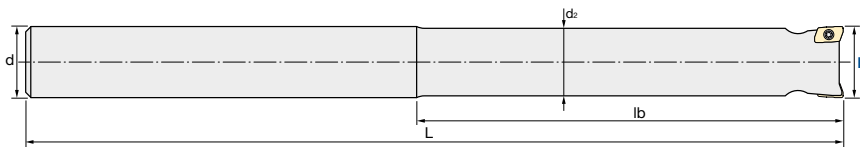
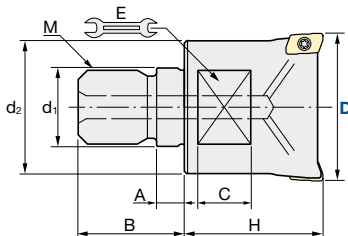


Fig. 2: Carbide Shank

Diameter Holder only [mm]	Fastening Torque [Nm]
-0.046 / -0.096 mm	0.5 Nm

Shank Type		Flutes	D	L	lb	d	d ₂	Shank	Coolant hole	a _p max
FH234	ASPV-1010R-2WL	2	10	130	75	10	9.5	Carbide (Fig. 2)	No coolant hole	2
FH235	ASPV-1012R-3WL	3	12	150	85	12	11.5			
FH236	ASPV-1016R-4WL	4	16	190	100	16	15			
FH237	ASPV-1020R-5WL	5	20	230	120	20	19			

ASPVM | Super Polish Mill-Mini | Modular Type


Diameter Holder only [mm]	Fastening Torque [Nm]
-0.046 / -0.096 mm	0.5 Nm

Modular Type		Flutes	D	H	d ₁	M	d ₂	A	B	C	Wrench	Coolant hole	a _p max
FH220	ASPVM-1010R-2-M6	2	10	20	6.5	M6	9.4	5.5	14.5	5	7	No coolant hole	2
FH221	ASPVM-1012R-3-M6	3	12										
FH222	ASPVM-1016R-4-M8	4	16	25	8.5	M8	12.8		17	8	10	With coolant hole	
FH223	ASPVM-1020R-5-M10	5	20										
FH224	ASPVM-1025R-6-M12	6	25	12.5	M12	20.8	22		17				
FH225	ASPVM-1032R-8-M16	8	32							17	M16	28.8	

Inserts
MPHT-0402...ZEL...

ASC | Carbide Shanks for Modular Mills & AS | Steel Shanks for Modular Mills: page 6/7

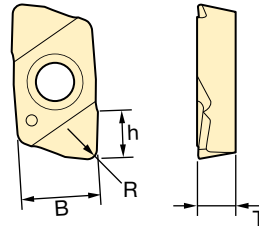
INSERTS ASPV | Super Polish Mill-Mini
MPHT-0402...ZEL...


Fig. 1

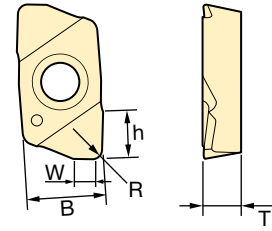


Fig. 2



Inserts		Tolerance Class	Grade	Size (mm)					Shape
ID Code	Item Code			JP4005	B	W	T	h	
WF322	MPHT-040202ZEL	H	•	4.3	No wiper	2	2.3	0.2	Fig. 1
WF323	MPHT-040202ZEL-0.5				0.5				Fig. 2
WF324	MPHT-040205ZEL				No wiper			Fig. 1	
WF325	MPHT-040205ZEL-0.5				0.5			Fig. 2	
WF326	MPHT-040205ZEL-1.0				1.0				
WF327	MPHT-040210ZEL				No wiper			Fig. 1	
WF328	MPHT-040210ZEL-0.5				0.5			Fig. 2	

JP4005

Multi layered PVD coating + Ultra micro grain substrate

Cutting Conditions | Schnittwerte | Condizioni di taglio | Condiciones de Corte | Conditions de coupe | Valores de corte:

 Bottom finishing  Page 8-9 | Vertical wall finishing  Page 10-11

Clamp Screw		Screw Driver	
			
ID-Code	Item-Code	ID-Code	Item-Code
ET052	240-140	ET056	104-T6

ASPV | Super Polish Mill-Mini

Features and Applications ASPV Mini

1. High-efficiency finishing

- Multi flutes for higher speed & feed
- 3 types of body will fit in all application
- High accuracy insert provides good surface quality.

2. Body line-up: 3 types of high accuracy body

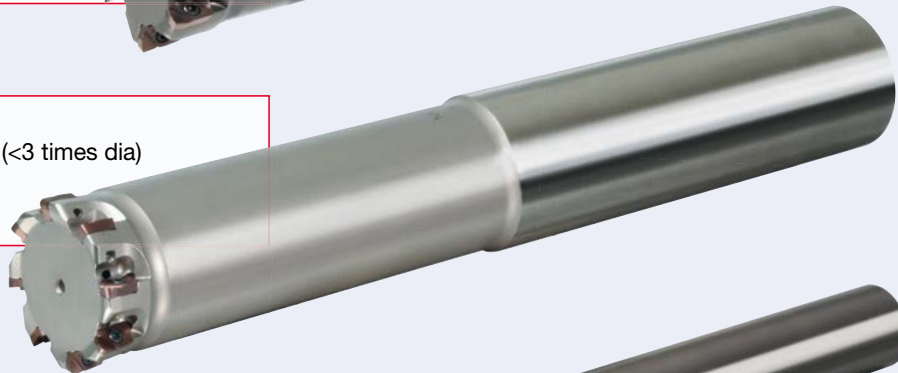
2.1. Modular type:

- For multi usage
- Dia 10–32
- 2–8 flutes



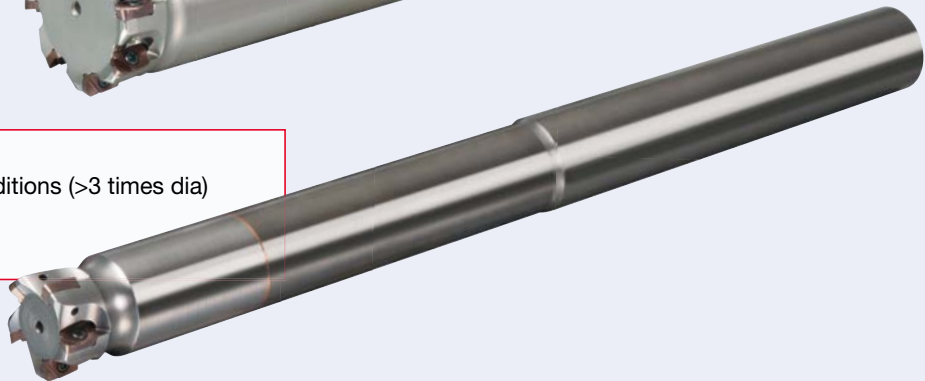
2.2. Steel shank type:

- For short overhang conditions (<3 times dia)
- Dia 10–32
- 2–8 flutes



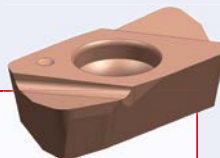
2.3. Carbide shank type:

- For extra long overhang conditions (>3 times dia)
- Dia 10–20
- 2–5 flutes

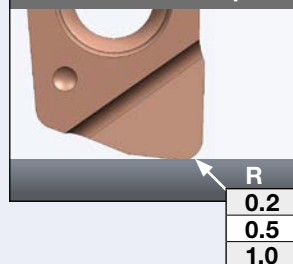


2.4. Insert line-up

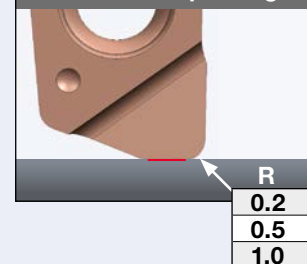
- Tolerance Class H
- All ground face for high accuracy, better surface quality & longer tool life.
- Nano-layered coating & Ultra micro grain JP4005
- **Selectable corner-R & wiper edge**



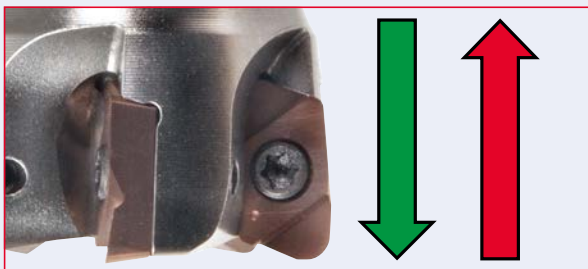
2.4.1. Without wiper



2.4.2. With wiper edge



3. Cautions during use – vertical milling:



Plunging – down (green direction)

- Possible.
- Please adjust cutting condition in case of long OH.

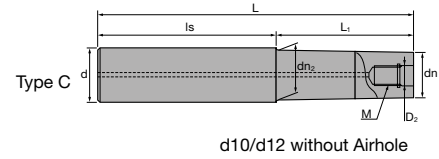
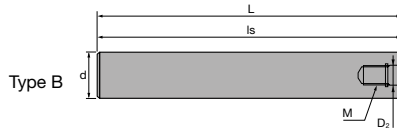
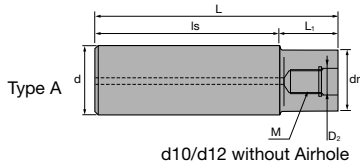
Plunging – up (red direction)

- Please don't use.
- Interference and breakage will happen.









ASPV | Super Polish Mill-Mini

<p>🇩🇪 Besonderheiten und Applikationen ASPV Mini</p>		
<p>1. Hocheffizientes Schlichten</p> <ul style="list-style-type: none"> Größere Schneidanzahl für mehr Geschwindigkeit & Vorschub 3 verschiedene Halter – passend für jede Applikation Hochpräzise Schneidplatten für beste Oberflächenqualität <p>2. Halter-Auswahl: 3 Typen von Hochpräzisions-Haltern:</p> <p>2.1. Modular:</p> <ul style="list-style-type: none"> Für vielfältigste Anwendungen 	<ul style="list-style-type: none"> Durchmesser 10–32 mm 2–8 Schneiden <p>2.2. Mit Stahlschaft:</p> <ul style="list-style-type: none"> Für geringe Auskraglängen (<3 x D) Durchmesser 10–32 mm 2–8 Schneiden <p>2.3. Mit Vollhartmetallschaft:</p> <ul style="list-style-type: none"> Für extra große Auskraglängen (>3 x D) Durchmesser 10–20 mm 2–5 Schneiden 	<p>2.4. Schneidplatten-Auswahl:</p> <ul style="list-style-type: none"> Toleranzklasse H Alle Flächen geschliffen für höchste Präzision, Oberflächenqualität & Werkzeug-Standzeit Feinstkorn-Schneidplatten mit JP4005 Nano-Beschichtung Verschiedene Eckenradien & Wiper 2.4.1. Ohne Wiper 2.4.2. Mit Wiper <p>3. Beim Vertikalfräsen unbedingt beachten:</p> <p>Eintauchfräsen – abwärts (grüne Richtung)</p> <ul style="list-style-type: none"> Anwendung möglich. Bei großen Auskraglängen Schnittbedingungen anpassen. <p>Eintauchfräsen – aufwärts (rote Richtung)</p> <ul style="list-style-type: none"> Nicht empfehlenswert. Erhöhte Rattermarken- und Bruchgefahr.
<p>🇪🇸 Características y aplicaciones ASPV Mini</p>		
<p>1. Acabado de alta eficiencia</p> <ul style="list-style-type: none"> Herramienta multiplaca para una mayor velocidad y avance. 3 tipos de soporte para encajar en todas las aplicaciones Placas de alta precisión para una buena calidad superficial. <p>2. Características de los soportes: 3 tipos de soportes de alta precisión</p> <p>2.1. Modular</p> <ul style="list-style-type: none"> Para múltiples usos. Dia 10 – 32 	<ul style="list-style-type: none"> 2–8 labios <p>2.2. Mango de acero:</p> <ul style="list-style-type: none"> Para voladizos cortos (< 3 x D) Dia 10 – 32 2–8 labios <p>2.3. Mango Metal Duro:</p> <ul style="list-style-type: none"> Para voladizo largos (> 3 x D) Dia 10–20 2–5 labios 	<p>2.4. Características de las placas</p> <ul style="list-style-type: none"> Tolerancia Clase H. Completamente rectificadas para una mayor precisión, mejor calidad superficial & mayor vida de la herramienta. Recubrimiento Nano-capas & Ultra micrograno JP4005 Disponibles con radio R & con wiper 2.4.1. Sin wiper 2.4.2. Con wiper <p>3. Precauciones durante el uso – fresado vertical:</p> <p>Fresado vertical – hacia abajo (flecha verde)</p> <ul style="list-style-type: none"> Adecuado. Por favor, ajustar condiciones de corte en caso de grandes voladizos (OH). <p>Fresado vertical – hacia arriba (flecha roja)</p> <ul style="list-style-type: none"> No utilizar. Se producirían interferencias y la rotura de la herramienta.
<p>🇮🇹 Caratteristiche ed applicazioni ASPV Mini</p>		
<p>1. Finitura ad alta efficienza</p> <ul style="list-style-type: none"> Multitaglienti per una più alta velocità ed avanzamento 3 tipologie di corpi fresa la rendono adatta per ogni applicazione L'alto grado di precisione degli inserti garantisce un'ottima qualità di finitura. <p>2. Gamma dei corpi fresa: 3 tipi di corpi ad alta precisione</p> <p>2.1. Tipo modulare:</p> <ul style="list-style-type: none"> Per utilizzi vari 	<ul style="list-style-type: none"> Diametri da 10 a 32 mm 2–8 inserti <p>2.2. Gambo in acciaio:</p> <ul style="list-style-type: none"> Per lavorazioni a bassa sporgenza (<3 volte il diametro) Diametri da 10 a 32 mm 2–8 inserti <p>2.3. Gambo in metallo duro integrale:</p> <ul style="list-style-type: none"> Per lavorazioni ad alta sporgenza (>3 volte il diametro) Diametri da 10 a 20 mm 2–5 inserti 	<p>2.4. Gamma inserti</p> <ul style="list-style-type: none"> Classe di Tolleranza H Geometria per risultati ad alta precisione, miglior qualità di finitura e maggiore durata del tagliente. Rivestimento a nano-strati & substrato ad Ultra micrograna JP4005 Raggio torico R e raschiante selezionabili 2.4.1. Senza raschiante 2.4.2. Con raschiante <p>3. Avvertenze durante l'utilizzo – fresatura verticale:</p> <p>Verso il basso – Plunging down (Direzione verde)</p> <ul style="list-style-type: none"> Possibile Modificare opportunamente le condizioni di taglio in caso di alte sporgenze <p>Verso l'alto – Plunging up (Direzione rossa)</p> <ul style="list-style-type: none"> Da non utilizzare Possibilità di rotture e tallonamenti.
<p>🇫🇷 Particularités et Applications de l'ASPV Mini</p>		
<p>1. Finition Haute efficacité</p> <ul style="list-style-type: none"> Multi dents pour une plus grande vitesse & avance 3 types de corps de fraises couvrant toutes les applications De bons états de surfaces grâce aux plaquettes hautes tolérances <p>2. Corps de fraises: 3 types de corps haute précision</p> <p>2.1. Type Modulaire:</p> <ul style="list-style-type: none"> Pour des usages multiples Diamètre 10–32 	<ul style="list-style-type: none"> 2–8 dents <p>2.2. Type queue cylindrique en acier:</p> <ul style="list-style-type: none"> Pour des applications à faibles porte à faux (<3 fois le diamètre) Diamètre 10–32 2–8 dents <p>2.3. Type queue cylindrique en carbure:</p> <ul style="list-style-type: none"> Pour des applications à porte à faux importants (>3 fois le diamètre) Diamètre 10–20 	<ul style="list-style-type: none"> 2–5 dents <p>2.4. Gamme des plaquettes</p> <ul style="list-style-type: none"> Tolérance Classe H Plaquettes intégralement rectifiées pour plus de précision, une meilleure qualité surfacique & une grande durée de vie Revêtement Nano couche & Ultra micro grain JP4005 Rayons de tore au choix & arrête wiper 2.4.1. Sans arrête wiper 2.4.2. Avec arrête wiper <p>3. Précautions d'utilisation – Tréflage:</p> <p>Plongée – vers le bas (fleche verte)</p> <ul style="list-style-type: none"> Possible. Adapter les conditions de coupe en cas de long porte à faux. <p>En tirant – vers le haut (fleche rouge)</p> <ul style="list-style-type: none"> Ne pas utiliser. Une casse surviendra à cause des interférences.
<p>🇵🇹 Características e aplicações ASPV Mini</p>		
<p>1. Acabamento de alta eficiência</p> <ul style="list-style-type: none"> Mais plaquetas para Alta velocidade 3 Tipos de corpos para várias aplicações Plaquete de alta precisão garante alta qualidade superfície <p>2. Tipos de corpos: 3 tipos de corpos alta precisão</p> <p>2.1. Tipo Modular:</p> <ul style="list-style-type: none"> Para multiuso 	<ul style="list-style-type: none"> Dia 10–32 2–8 plaquetas <p>2.2. Encabadouro em aço:</p> <ul style="list-style-type: none"> Para situações Curtas (<3 vezes Dia) Dia 10–32 2–8 plaquetas <p>2.3. Encabadouro em M/duro:</p> <ul style="list-style-type: none"> Para situações extra longas superiores (> 3 vezes Dia) Dia 10–20 2–5 plaquetas 	<p>2.4. Linha de plaquetes</p> <ul style="list-style-type: none"> Tolerância classe H Toda face de chão de alta precisão, melhor qualidade de superfície & maior vida útil da ferramenta. Revestimento de nano-camadas & Ultra micro grão JP4005 Raio selecionável – R & aresta “wiper” 2.4.1. Sem “wiper” 2.4.2. Com “wiper” <p>3. Precauções durante a utilização – Maquinação vertical:</p> <p>Maquinação – De cima para baixo (Direção verde)</p> <ul style="list-style-type: none"> Possível. Por favor, ajuste as condições de corte em situações longas OH. <p>Maquinação – De baixo para cima (Direção vermelha)</p> <ul style="list-style-type: none"> Por favor não usar Interferência e rotura vai acontecer

ASC | Carbide Shanks for Modular Mills


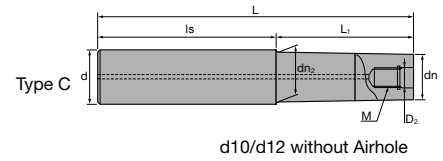
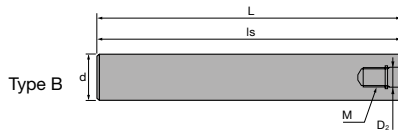
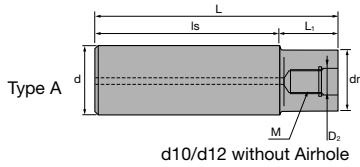
Carbide Shank																
	ID Code	Item Code	D ₂	M	L	L ₁	Is	dn	dn ₂	d	Type					
Without Airhole	FH137	ASC10-6.5-74-24	6.5	M6	74	24	50	9.3	-	10	A					
	FH254	ASC10-6.5-84-34			84	34										
	FH255	ASC10-6.5-114-24			114	24						90				
	FH138	ASC10-6.5-114-49			114	49	65									
	FH139	ASC12-6.5-74-24			74	24	50					11	11.5	12	C	
	FH256	ASC12-6.5-94-44			94	44										
	FH257	ASC12-6.5-129-24			129	24										105
	FH140	ASC12-6.5-129-64			129	64										65
With Airhole	FH141	ASC16-8.5-95-30	8.5	M8	95	30	65	14.5	15.5	16	C					
	FH258	ASC16-8.5-120-55			120	55										
	FH142	ASC16-8.5-140-75			140	75										
	FH260	ASC16-8.5-160-30			160	30						130				
	FH259	ASC16-8.5-160-95			160	95						65				
	FH143	ASC20-10.5-120-50	10.5	M10	120	50	70	18	-	20	A					
	FH261	ASC20-10.5-170-90Z			170	90	80	18.5	19.5		C					
	FH144	ASC20-10.5-220-50			220	50	170	18	-		A					
	FH262	ASC20-10.5-220-120Z			220	120	100	18.5	19.5		20	C				
	FH263	ASC20-10.5-270-150Z			270	150	120									
	FH264	ASC20-10.5-270-50Z			270	50	220									
	FH145	ASC25-12.5-145-65			12.5	M12	145	65	80		23	-	25	A		
	FH146	ASC25-12.5-265-65	265	200												
	FH265	ASC25-12.5-215-115	215	115			100									
	FH266	ASC25-12.5-265-145	265	145			120									
	FH268	ASC25-12.5-315-65	315	65			250									
	FH267	ASC25-12.5-315-195	315	195			120									
	FH147	ASC32-17-160-80	17	M16			160	80	80	28					-	32
	FH269	ASC32-17-260-140			260	140	120									
	FH148	ASC32-17-310-80			310	80	230									
FH270	ASC32-17-360-240	360			240	120										

 SUPER Lock milling chucks or shrink-fit holders can be used.
 SUPER Lock Aufnahmen oder Schrumpffutter können verwendet werden.
 Possono essere utilizzati mandrini a forte serraggio SUPER Lock.

 Aptos para amarrar en portapinzas SUPER Lock.
 Les attachements SUPER Lock peuvent être utilisés.
 Cones hidráulicos de grande aperto e aperto térmico podem ser usados.



AS | Steel Shanks for Modular Mills



Steel Shank											
	ID Code	Item Code	D ₂	M	L	L ₁	ls	dn	dn ₂	d	Type
Without Airhole	FH131	AS10-6.5-74-0	6.5	M6	74	-	74	-	-	10	B
	FH132	AS12-6.5-84-4			84	4	80	11			A
With Airhole	FH133	AS16-8.5-95-15	8.5	M8	95	15	80	14.5	15.5	16	A
	FH134	AS20-10.5-100-20	10.5	M10	100	20		18	-	20	
	FH271	AS25-12.5-115-35	12.5	M12	115	35		23	23	25	
	FH272	AS32-17-110-30	17	M16	110	30		28	28	32	

🇬🇧 SUPER Lock milling chucks can be used.

🇩🇪 SUPER Lock Aufnahmen können verwendet werden.

🇮🇹 Possono essere utilizzati mandrini a forte serraggio SUPER Lock.

🇪🇸 Aptos para amarrar en portapinzas SUPER Lock.

🇫🇷 Les attachements SUPER Lock peuvent être utilisés.

🇵🇹 Cones hidráulicos de grande aperto e aperto térmico podem ser usados.

- 🇬🇧 For further information about modular chucks please see our brochure *Indexable Modular Series No. 328*
- 🇩🇪 Weitere Informationen über modulare Werkzeugaufnahmen finden Sie in unserem Prospekt: *Indexable Modular Series No. 328*
- 🇪🇸 Para obtener más información sobre conos modulares consulte nuestro folleto *Indexable Modular Series No. 328*
- 🇮🇹 Per maggiori informazioni riguardanti la gamma dei mandrini avvitabili consultate il catalogo *Indexable Modular Series No. 328*
- 🇫🇷 Pour de plus amples informations concernant les attachements modulaires, consultez SVP notre brochure *Indexable Modular Series No. 328*
- 🇵🇹 Para mais informações sobre Conos Modulares consulte o nosso folheto *Indexable Modular Series No. 328*

